

ENERGY SOURCEBOOK

ELEMENTARY UNIT

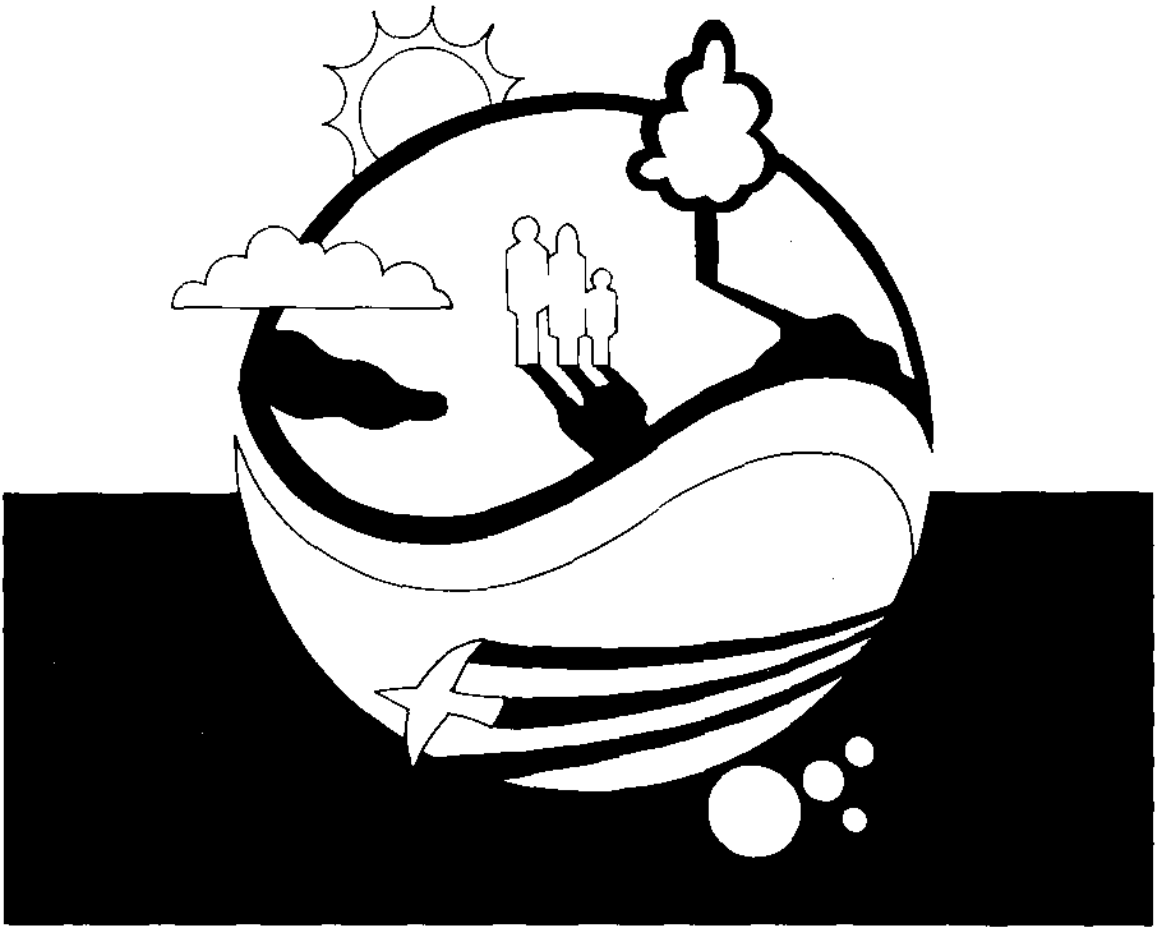

Tennessee Valley Authority
Marketing Communications, Customer Group
Environmental Education, Resource Group

Reprinted October 1992

DISCLAIMER

This document was prepared for the Tennessee Valley Authority (TVA) by teachers in the Tennessee Valley in cooperation with the TVA Network of University-Based Centers and Cooperatives for Environmental Education. Neither the preparers, TVA, nor any persons acting on their behalf:

- a. make any warranty or representation, expressed or implied, with respect to the use of any information contained in this document, or that the use of any information, apparatus, method, or process disclosed in this document may not infringe on privately owned rights; or
- b. assume any liabilities with respect to the use of, or for damages resulting from the use of any information, apparatus, method, or process disclosed in this document.

This document does not necessarily reflect the views and policies of TVA. The use of specific brand names or products should not be construed as an endorsement of TVA.

TVA is an equal opportunity and affirmative action employer. TVA also ensures that the benefits of programs receiving TVA financial assistance are available to all eligible persons regardless of race, color, national origin, handicap, or age.

For more information contact the Environmental Education Program, Forestry Building, Norris, Tennessee 37828 or (615) 632-1570.

ACKNOWLEDGEMENTS

TVA gratefully acknowledges the time and energy of the teachers, directors, and staff who participated in the development of the "Energy Sourcebook."

Coordinating Centers

Cedar Creek Learning Center
Greene County Schools
Greeneville, Tennessee 37743
Doug Ratledge, Director
Violet Parr Carlos, Assistant Director
Jim Holt and Jerry Rhinehardt, Instructors

University of Alabama in Huntsville
Johnson Research Center
Environmental and Energy Education Program
Huntsville, Alabama 35899
Mr. Bernard M. Levine, Director
Annie Williams, Angela C. Eyman, Paulette Paul, Rebecca A. Spin, Student Assistants
Laurie Collins, Secretary

Western Kentucky University
Center for Math, Science, and Environmental Education
Bowling Green, Kentucky 42101
Dr. Glenn H. Crumb, Director
Joan Martin, Program Coordinator
Dr. Robert L. Stevenson, Science Education Consultant

Authors

Pat Barnett, Highland Elementary, Greeneville, Tennessee
Judy Bowman, Arab Elementary, Arab, Alabama
Nancy Causey, Mosheim Elementary, Mosheim, Tennessee
Ollie Jones, Mountain Gap Elementary, Huntsville, Alabama
Linda Lawler, Whitesburg Elementary, Huntsville, Alabama
Lynne Patrick, Elkmont School, Elkmont, Alabama
Tom M. Perdue, Adairville Elementary, Adairville, Kentucky
Linda Roller, Hazel Green School, Hazel Green, Alabama
Deborah Lynne Ross, Wayland Alexander School, Hartford, Kentucky
Catherine Marie Thompson, H.W. Wilkey School, Leitchfield, Kentucky
Linda Walker, Montview Elementary, Huntsville, Alabama

Testing Teachers

Peggy Bentley, Dade Middle School, Trenton, Georgia
Jennifer Blevins, Dade Middle School, Trenton, Georgia
Richard Blevins, Shady Valley Elementary, Shady Valley, Tennessee
Patty Bowen, Unicoi Elementary, Unicoi, Tennessee
Cynthia Brown, Scottsville Elementary, Scottsville, Kentucky
Marilyn Brown, Mountain City Elementary, Mountain City, Tennessee
Nancy Bush, South Green Elementary, Glasgow, Kentucky
Marilyn Chambers, South Green Elementary, Glasgow, Kentucky
Linda S. Cropper, Tompkinsville Elementary, Tompkinsville, Kentucky
Marilyn W. Crow, Scottsville Elementary, Scottsville, Kentucky
Doris Curd, Laurel Elementary, Laurel Bloomery, Tennessee
Jackie Downing, Lewisburg School, Lewisburg, Kentucky
Maurine Duggar, Piney Chapel School, Athens, Alabama
Mike Edmonds, Boones Creek Elementary, Gray, Tennessee
Alex Fitzpatrick, Kyrock Elementary, Sweeden, Kentucky
Sara Fitzpatrick, Scottsville Elementary, Scottsville, Kentucky
Pat Honaker, Shady Valley School, Shady Valley, Tennessee
Kathy James, Shouns School, Mountain City, Tennessee
Rossie B. Kingery, South Green Elementary, Glasgow, Kentucky
Terri Knight, University High, Johnson City, Tennessee
Barbara G. Lassiter, Lewisburg School, Lewisburg, Kentucky
Vicky Livesay, Trade School, Trade, Tennessee
Kay Loggins, Piney Chapel, Athens, Alabama
Michael Meredith, Kyrock Elementary, Sweeden, Kentucky
Mary Alice Minton, Kyrock Elementary, Sweeden, Kentucky
Diane Noles, East Elementary, Cullman, Alabama
Marlene Ross, Tompkinsville Elementary, Tompkinsville, Kentucky
Leanna Scheels, Hal Henard School, Greeneville, Tennessee
Lu Shaw, Lewisburg School, Lewisburg, Kentucky
Cecilia Stephens, Tompkinsville Elementary, Tompkinsville, Kentucky
Sharon Taylor, Neva Elementary, Mountain City, Tennessee
Doris B. Wolff, Welts Junior High, Cullman, Alabama
Glenda H. Wright, Welts Junior High, Cullman, Alabama

Special thanks are also extended to:

Anne Allen, Tennessee Energy Education Network
Dr. Barbara J. Anthony, Alabama A&M University
Marilyn Carden, Contributing Artist, Fort Payne (Alabama) City Schools
Pepe' Ferraro, Paste Up Artist, Knoxville, Tennessee
Susanna Harris, Primary Illustrator, Oak Ridge, Tennessee
Cheryl Shelton, Education Consultant, Madison, Alabama

DISTRIBUTION

TVA's Environmental Education Section administers a network of centers for environmental education. Each center has four primary functions: teacher training, program development and distribution, regional service, and research. For more information on their programs contact the center nearest you.

Dr. Jackie Batson, Director
Environmental Education Center
Tennessee Wesleyan College
Athens, Tennessee 37303
(615) 745-7504, ext. 236

Dr. Bernard Benson, Director
Center for Environmental, Energy and Science Education
The University of Tennessee at Chattanooga
Chattanooga, Tennessee 37403
(615) 755-4237/4126

Dr. Richard C. Berne, Director
Center for Environmental/Energy Education
Western Carolina University
Cullowhee, North Carolina 28723
(704) 227-7476

Mr. Greg N. Cox, Director
Johnson Research Center
University of Alabama in Huntsville
Huntsville, Alabama 35899
(205) 895-6257

Dr. Maurice Field, Director
Center for Environmental and Conservation Education
The University of Tennessee at Martin
Martin, Tennessee 38238
(901) 587-7200

Dr. Susan P. Gannaway, Director
Center for Science, Mathematics, and Environmental Education
North Georgia College
Dahlonega, Georgia 30597-9990
(404) 864-1533

Dr. Earl Gardner, Director
Center for Environmental, Energy, and Science Education
The University of North Alabama
Florence, Alabama 35632
(205) 760-4228

Dr. Ruth Jacquot, Director
Center for Environmental Education
Murray State University
Murray, Kentucky 42071
(502) 762-2534

Dr. Padgett Kelly, Director
Center for Environmental/Energy Education
Middle Tennessee State University
Murfreesboro, Tennessee 37132
(615) 898-5920

Dr. Rosalyn McKeown-Ice, Director
Center for Geography and Environmental Education
The University of Tennessee at Knoxville
Knoxville, Tennessee 37996-3400
(615) 974-3994

Mrs. Jill Norvell, Director
Center for Environmental/Energy Education
Memphis State University
Memphis, Tennessee 38152
(901) 678-2545

Mr. Doug Ratledge, Director
Cedar Creek Learning Center
c/o Greene County Schools
Greeneville, TN 37743
(615) 638-6100 (Cedar Creek)

Dr. Charles F. Rhyne, Director
Center for Environmental, Energy and Science Education
Jackson State University
Jackson, Mississippi 39217
(601) 968-7062

Dr. Joseph Sharp, Director
Center for Environmental/Energy Education
Tennessee Technological University
Cookeville, Tennessee 38505
(615) 372-3459

Dr. Terry Wilson, Director
Center for Mathematics, Science and Environmental Education
Western Kentucky University
Bowling Green, Kentucky 42101
(502) 745-4424

Mr. Jim Yonge, Director
Mississippi Cooperative Extension
Mississippi State University
Mississippi State, Mississippi 39726
(601) 325-3350

TABLE OF CONTENTS

| | |
|--|-------|
| Introduction..... | i |
| Curriculum Framework..... | iii |
| Energy | |
| The Invisible Force..... | E-1 |
| Check Out the Power..... | E-8 |
| What Makes It Work?..... | E-17 |
| We've Got the Power..... | E-23 |
| Read All About It..... | E-29 |
| Spreading the Heat Around..... | E-42 |
| Light on Your Feet..... | E-47 |
| S. O. S. (Save Our Sources)..... | E-50 |
| Glossary..... | E-55 |
| Electricity | |
| Links in a Chain..... | EL-1 |
| Safety First..... | EL-9 |
| To Attract or Not to Attract..... | EL-12 |
| Mr. Conductor—Please!..... | EL-19 |
| Going Around in Circuits..... | EL-26 |
| Where Does It All Come From?..... | EL-33 |
| From the Generator to You..... | EL-41 |
| Energy in Motion..... | EL-50 |
| Glossary..... | EL-57 |
| Renewable Energy Resources | |
| A Box of Sunshine..... | R-1 |
| From the Sun to You..... | R-9 |
| Solar Sizzling!..... | R-12 |
| Solar Greenhouses..... | R-20 |
| Be "Sun"-sible About Heating Water..... | R-27 |
| Then and Now..... | R-35 |
| Oh! How the Wind Blows!..... | R-41 |
| Energy From Water—Free for the Taking..... | R-47 |
| To Burn or Not to Burn..... | R-55 |
| Glossary..... | R-60 |
| Energy and the Environment | |
| To Use or Not to Use..... | EN-1 |
| Atmospheric Monsters..... | EN-9 |
| Acid Rain—What a Pain!..... | EN-19 |
| The Water Cycle—Again and Again and Again..... | EN-30 |
| All Washed Up..... | EN-37 |
| Down the Drain—Never!..... | EN-43 |
| Trashy Solutions..... | EN-49 |
| This Land Is Your Land..... | EN-56 |
| Glossary..... | EN-62 |

Energy Conservation

| | |
|-----------------------------------|------|
| Yesterday and Today | C-1 |
| Wasting Energy at Home? | C-8 |
| Dress for Comfort | C-16 |
| Plugging the Leaks | C-19 |
| Conserving Energy at School | C-25 |
| On the Road Again | C-30 |
| Again and Again | C-34 |
| How Many? How Much? | C-40 |
| Glossary | C-44 |

Energy in the Valley

| | |
|---------------------------------------|-------|
| Down in the Valley | EV-1 |
| Resource—Full | EV-6 |
| A Time for Change | EV-10 |
| The Good Old Days? | EV-14 |
| Pollution, Pollution Everywhere | EV-18 |
| Looking Ahead | EV-27 |
| Glossary | EV-32 |

Factsheets

| | |
|--|-------|
| Energy | FS-1 |
| Matter and Energy | FS-3 |
| Kinetic and Potential Energy | FS-5 |
| Heat Energy | FS-7 |
| Light Energy | FS-9 |
| Electricity | FS-10 |
| Hydropower | FS-13 |
| Energy From Coal | FS-15 |
| Nuclear Energy | FS-17 |
| Solar Energy | FS-19 |
| Energy Conservation | FS-21 |
| Renewable and Nonrenewable Resources | FS-23 |
| Energy and Solid Waste | FS-25 |
| Energy History | FS-26 |
| TVA History | FS-28 |

INTRODUCTION

Today's students are tomorrow's workers, leaders, consumers, and voters. They will live in a world that will undoubtedly be more highly technological than the present. Because of this certainty, quality education at all levels has become more critical than ever before.

The need for improved science and mathematics education has been stressed in a variety of forums recently. A solid foundation in these two subject areas is essential to preparing students for not only the kinds of work they are most likely to desire as adults but also the kinds of issues with which they will grapple. An understanding of basic scientific, technological, and environmental concepts is becoming more and more necessary in order to participate effectively in the social, economic, and political processes of today's world.

Recent studies show that students in American schools lag behind their peers in other developed countries in academic achievement. This is particularly apparent in measures of science and mathematics proficiency. Fewer American college students are entering demanding academic programs in science and engineering; as our need for these professionals increases, our supply is decreasing. Many American adults are functionally illiterate in science and technology, and industries spend tens of billions of dollars each year training workers who are inadequately prepared. Lack of the skills needed in our technologically advanced society is costly in many ways—to us all. It also deprives people of the opportunities of which they might take advantage were they equipped to do so.

One of the proposed courses of action to mitigate this coming crisis is to boost science and mathematics education in the elementary grades. As these young students are developing attitudes and aptitudes that will color the rest of their educational experiences (and their lives), it is critical that they receive the best instruction and the most opportunities possible. To this end, the "Energy Sourcebooks" are developed and offered to help teachers prepare their students for tomorrow's world.

The purpose of the "Energy Sourcebook—Elementary Unit" is to integrate energy education into the existing curricula by providing instructional materials that are specific to the Tennessee Valley. The book contains plans for a variety of learning experiences and addresses energy issues with a balanced approach. It is heavily concentrated in science (especially physical science) and, to a lesser degree, math. The "Sourcebook" is intended to aid elementary grade teachers in teaching not only basic science but the real-life application of these principles in energy studies.

DEVELOPMENT

The "Sourcebook" was developed in three stages. Third, fourth, and fifth grade classroom teachers were selected to write the activities with the assistance of education specialists. Teams of teachers were given the task of developing and writing the activities for each of the six instructional chapters. The second step involved testing the activities in the classroom. New teachers were selected to use the activities in their classrooms. Each activity was tested by at least two teachers. From the evaluations provided by the testing teachers, revisions were made. Finally, technical reviews, editing, and illustrations completed the "Energy Sourcebook—Elementary Unit."

ORGANIZATION

"The Energy Sourcebook" has seven chapters. One chapter is factsheets to provide teachers with information on various energy topics. There are six instructional chapters. Each of them has complete plans for classroom activities and demonstrations and a glossary of energy terms.

The first instructional chapter, "Energy," deals with defining and characterizing energy in different forms and examines energy principles and resources. The chapter dealing with electricity follows. Activities in "Electricity" investigate the nature, conduction, generation, and use of electrical energy. "Renewable Energy Resources" examines solar energy; energy from wind, water, and wood; and how energy use has shifted from renewable to nonrenewable sources. "Energy and the Environment" deals with the environmental effects of producing and using energy and includes basic environmental quality and resource use concepts. The chapter on "Energy Conservation" focuses on day-to-day applications of energy-saving techniques and why they are important. The final instructional chapter, "Energy in the Valley," examines a variety of resource use topics pertinent to the Tennessee Valley region.

ACTIVITY DESIGN

The first part of each activity contains its objectives, appropriate subject area(s), time requirement, and a comprehensive materials list. This information will aid teachers in determining how best to utilize the activities with their students.

Each activity is divided into three major sections. The "Background Information" section provides information that is specific to the activity for the teacher's use. Terms that may need to be discussed or reviewed with the students are listed and defined in this section. The activity itself is outlined in the "Procedure" and is divided in three subsections. "Setting the Stage" introduces the main ideas of the activity. The second subsection, "Activity," gives specific instructions for completing the steps of the activity. The third subsection, "Follow Up," may be utilized as evaluation and corresponds to the stated objectives. Some activities have a fourth subsection—"Extension." This part of the activity is optional. Some may be used as ongoing projects, while others may best be used as additional classroom work for more advanced students or for extra credit. "Resources" are listed at the end of most of the activities and include books, brochures, and other publications used in the development of the activities. These may also serve as sources of further information.

Each activity contains ready-made masters for the handout materials required for the activity's completion. These masters are easily removed from and replaced in the binder after photocopying (or producing a thermofax master for spirit duplication). Some plans also contain a master from which to make a suggested transparency for use with an overhead projector. Transparencies may be made by thermofax or by tracing.

CURRICULUM FRAMEWORK

The "Curriculum Framework" serves to correlate concepts or objectives stated by the Department of Education with the activities, identifying those that teach the specified concepts or objectives. Brief descriptions of the activities are included to aid teachers in choosing activities.

PAGINATION

Each chapter is page-numbered separately and is designated with an appropriate letter. For example, the "Energy" chapter begins with page E-1, the "Electricity" chapters begins with EL-1, and so on.

$$D = \frac{1}{c} \frac{dl}{dt} = \frac{1}{c} \frac{1}{P} \frac{dP}{dt}$$

$$D^2 \frac{1}{P} - P \sim \frac{1}{P^2} (1a)$$

$\sim \kappa \rho (2a)$

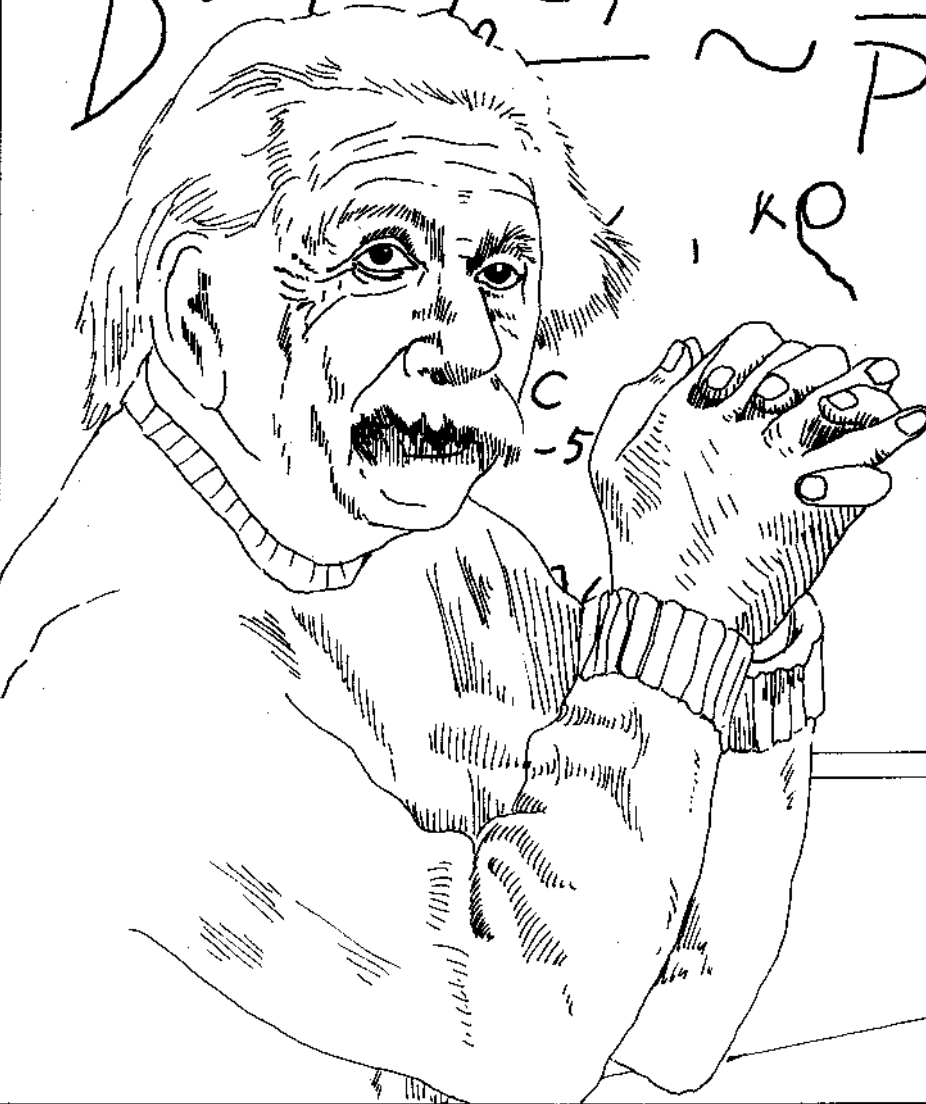

THE INVISIBLE FORCE

OBJECTIVES

The student will do the following:

1. Define the term energy, and list observable effects of energy.
2. Give examples of objects that utilize energy, and compare these objects when they have potential energy and when they display kinetic energy.
3. Classify objects into groups according to energy form: mechanical, electrical, chemical, solar, and nuclear.

SUBJECT:

Science

TIME:

100 - 120 minutes

MATERIALS:

jump rope, toy car, candle, flashlight, matches or lighter, tennis ball, magazines, student sheets (included)

BACKGROUND INFORMATION

Energy surrounds us. It is everywhere and it is abundant. It has no apparent mass and you can't touch it. But you can easily see and feel the effects it has on many different objects and materials. Anything that has energy can do work; that is, it has the ability to move (or change) itself or some other object.

Whenever we have heat, light, or motion, we have energy in action—kinetic energy. Whenever we have something (such as a lump of coal or a battery) that has the potential to provide heat, light, or motion, it has stored energy—potential energy.

There are many different forms of energy. Some forms are mechanical energy (the energy possessed by a moving object), electrical energy (electrons moving through wires), chemical energy (released when chemical compounds change or react), solar energy (directly observable as visible light, and indirectly as the source of food energy on which we depend), and nuclear energy (stored in the tiny, dense cores of atoms).

Terms

energy: the ability to do work.

kinetic energy: the energy of motion (or heat or light).

potential energy: stored energy; energy that will not do any work until released or changed.

PROCEDURE

I. Setting the stage

- A. Do the following classroom activities: Shine a flashlight in the students' eyes. Have a student jump rope. Have a student drop a ball to the floor. Roll a toy car down a ramp. Light a candle.
 1. Ask the students the following questions:
 - a. What did it take for each of these actions to occur? (energy)
 - b. What other actions (or work) occur(s) as a result of the use of energy? (Accept any reasonable answer.)
 2. Define the term energy.
- B. Share with the students the following information: Although energy itself cannot be observed, the effects of energy can definitely be seen, heard, or felt. If we just look around the room or anywhere in our environment, we see the effects of energy at work. Energy makes things give off heat or light, or move—it makes things change. While these objects are changing, we say "They are displaying kinetic energy." When these objects are not doing work, we say "They have potential energy."

II. Activity

- A. Have the students demonstrate work being done.
 1. Have each student list five situations in which work is being done.
 2. Have each student act out or mimic one of the objects or situations they have listed as his/her classmates try to guess what is being portrayed. The first student to guess the object being acted out then acts out an object from his/her list. Continue this pattern until all the students have had chances to act out one item from their lists. (Suggestion: Set a time limit for each student.)
 3. Discuss with the students how work is being done in each situation. Decide whether each change is movement, heat, or light. (Some examples may be more than one of the three.)
- B. Review with the students the concepts of kinetic energy and potential energy. Compare kinetic energy with potential energy.
 1. Have a student hold a tennis ball two feet above the floor. Ask the students if the ball is displaying kinetic energy. (No.) Is there potential energy? (Yes; the tennis ball could be dropped, displaying an effect of energy—movement.) Explain that the ball has potential energy. Discuss the concept of potential energy and illustrate it until the students understand.
 2. Have a student take the ball, hold it two feet from the floor, and then drop it. Lead the students to discover that they have just observed kinetic energy in the movement of the ball. Discuss kinetic energy and illustrate the concept until the students understand it.

3. Have a student hold the tennis ball three feet above the floor. Ask if the ball is displaying potential or kinetic energy. (Potential.) Ask if the ball now has more or less potential energy than previously observed. (More; its position is higher above the floor.) How do you know? How can we find out? (If we drop the ball from the higher position, we can observe that it will bounce higher than when it is dropped from the lower position.) Why will it bounce higher? (It will be moving faster—with more force—when it hits the floor because it was dropped from a higher position.) Lead the students to discover the conversion or transformation from potential to kinetic energy by observing the ball alternately being held and dropped.
4. Have the students make a chart using the items (objects) they listed in activity A. List the objects, the observed effect(s) of energy (movement, heat, and/or light), when the object has potential energy, and when it has kinetic energy.

Example:

| Object | Observation of Energy | Potential | Kinetic |
|---------------|-----------------------|-------------------|----------------------|
| 1. light bulb | light and heat | switch turned off | switch turned on |
| 2. bus | movement | parked | going down a highway |
| | | | |
| | | | |

(Some students may need help with this.)

5. Give each student a copy of the student sheet "POTENTIAL AND KINETIC ENERGY," included.
 - a. In part 1, the students are to decide if the pictured objects display potential or kinetic energy. Discuss the completed work with the students. (Answers: a. potential, b. kinetic, c. potential, d. potential, e. kinetic, f. kinetic.)
 - b. In part 2, the students are to rank each series of pictures from the greatest potential energy to the least potential energy. (Use the speed of movement as the criterion for the amount of energy shown in each picture.) Discuss their answers. Some pictures display both potential and kinetic energy.

Answers (left to right):

- a. 3, 2, 1
- b. 2, 3, 1

- C. Have the students classify forms of energy as mechanical, electrical, chemical, solar, or nuclear.
 1. Explain to the students that potential—stored—energy can be stored in many forms. For example, fuels store energy, as do batteries. Anything that stores energy has potential energy. When that energy is released or transformed so that we can observe it or use it, it is changed to kinetic energy. Kinetic energy also may be found in many forms. The heat, light, and/or motion we can observe can be the result(s) of many forms of kinetic energy in action. Some of those forms are mechanical, electrical, chemical, solar, and nuclear energy.

2. Define and discuss with the students examples of each form. **Adjust the complexity of the definitions and examples to the level of the students.**
 - a. Mechanical - energy of motion (e.g., parts of a machine)
 - b. Electrical - electrons moving through wires (e.g., electric lights)
 - c. Chemical - chemical compounds changing forms to provide energy (e.g., battery)
 - d. Solar - energy from the sun (e.g., light and warmth needed for plants to grow)
 - e. Nuclear - changing of the nuclei (cores) of atoms, releasing energy (e.g., nuclear reactor in a nuclear power plant).
3. Explain to the students that any of these forms of energy may be found as either potential or kinetic energy and that many objects use different forms of energy at one time. **Encourage the students to give examples other than those listed of situations in which each form of energy is used.**
4. Have the students add to the charts done in activity B.4. a column in which they identify the form of energy associated with the objects they listed. Discuss their answers with them.
5. Divide the students into four groups. Have each group cut out from magazines five pictures of one of the first four energy types. (For example Group 1 will find pictures representing mechanical energy; Group 2, electrical; and so on.) Some students may need guidance.
6. Display the pictures and discuss the types of energy and their states (potential or kinetic). (Suggestion: Use this as a bulletin board display.)

III. Follow-up

- A. Review with the students the definition of energy, some observable effects of energy, the states of energy, and the five forms of energy covered in activity C.
- B. Have the students complete the appropriate section(s) of the student sheet "THE INVISIBLE FORCE," included. Some students may need help with this.

Answers are as follows:

1. the ability to do work
2. arrow—move; wood—heat and/or light; bulb—light and/or heat
3. a. potential, b. potential, c. kinetic, d. potential, e. kinetic, f. kinetic
4. a. electrical, b. solar, c. mechanical, d. chemical, e. nuclear

RESOURCES

Fowler, J. M. Energy-Environment Sourcebook, Vols. 1 and 2. Washington, DC: National Science Teachers Association, 1975.

Townsend, R. D. Energy, Matter, and Change: Excursions into Physical Science. Glenview, IL: Scott, Foresman, 1973.

POTENTIAL AND KINETIC ENERGY

1. Label each picture. Use the terms potential and kinetic energy.

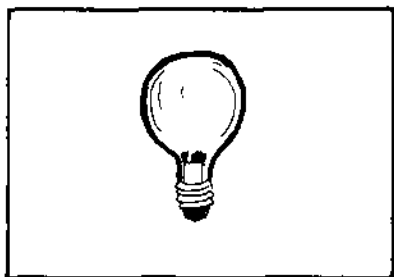

a. _____

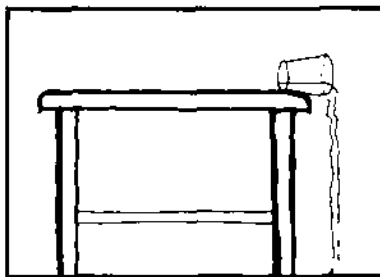

b. _____



c. _____

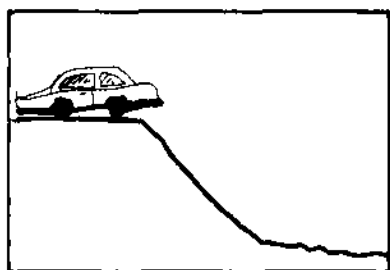

d. _____

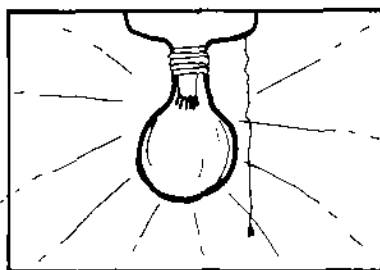

e. _____

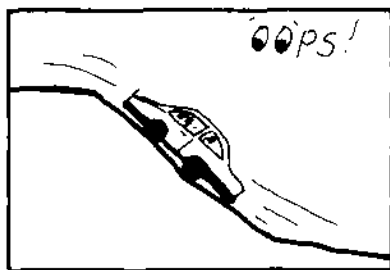

f. _____

2. Number the pictures in order from most to least potential energy. Use the number 1 for the most, 2 for the medium amount, and 3 for the least potential energy.

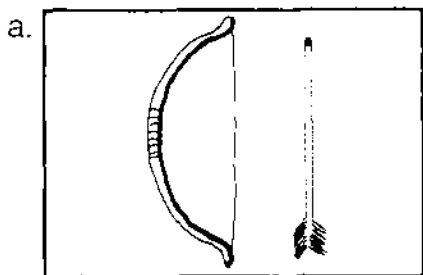

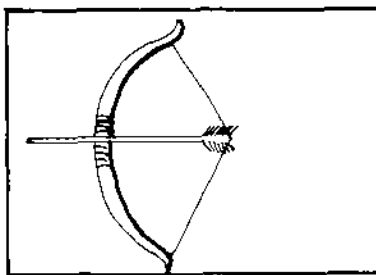

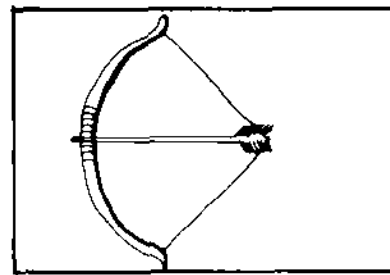

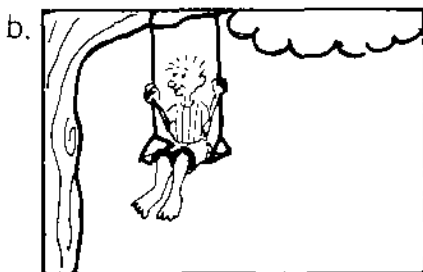

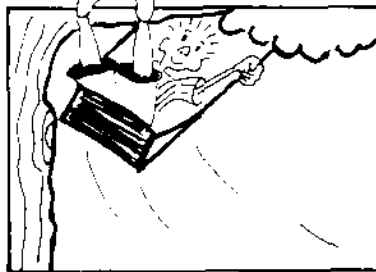

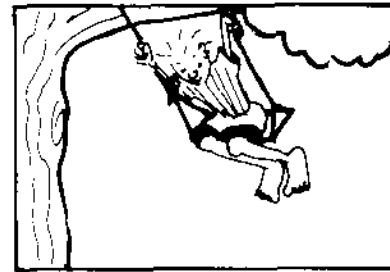



THE INVISIBLE FORCE

1. What is energy? _____

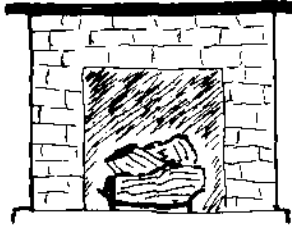
2. Draw a line from the object to the word that tells how energy changes it.

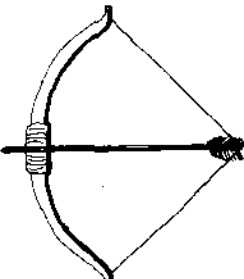





light

movement

heat

3. Label the pictures with the terms potential or kinetic energy.

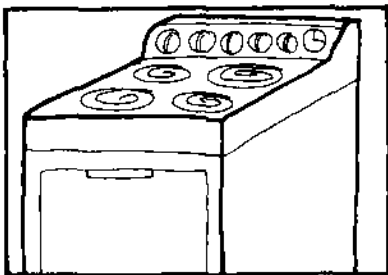

a. _____

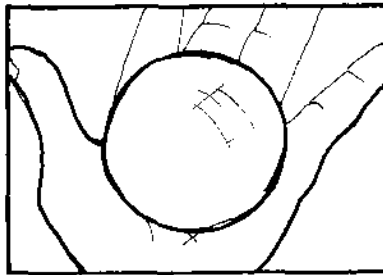

b. _____

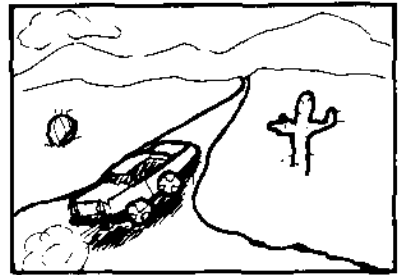

c. _____

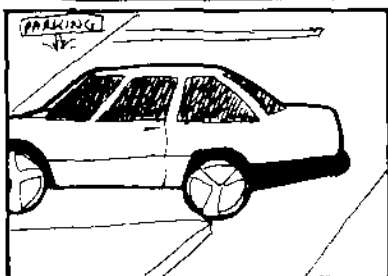

d. _____

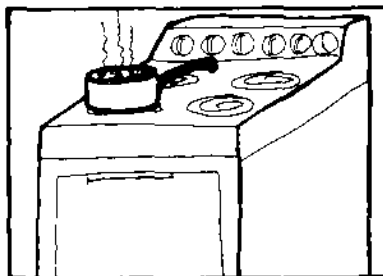

e. _____

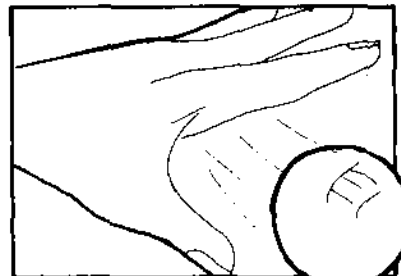

f. _____

THE INVISIBLE FORCE
(continued)

4. Write the form of energy shown in each picture. Use the following terms:

solar chemical electrical nuclear mechanical

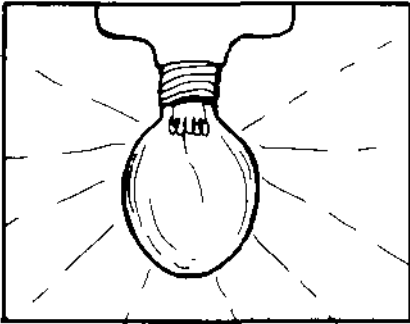

a. _____

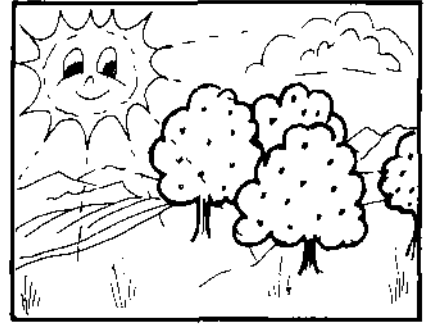

b. _____

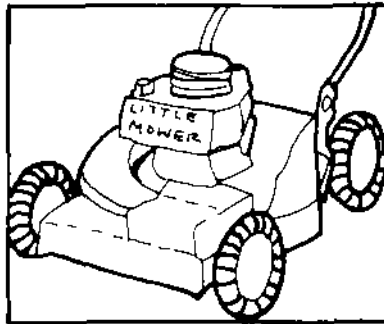

d. _____

e. _____

c. _____

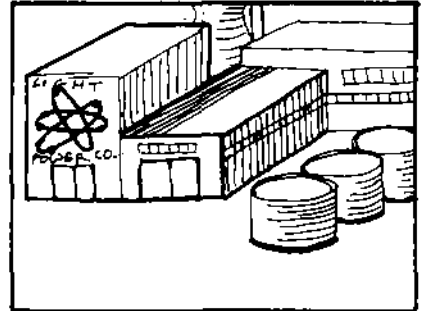
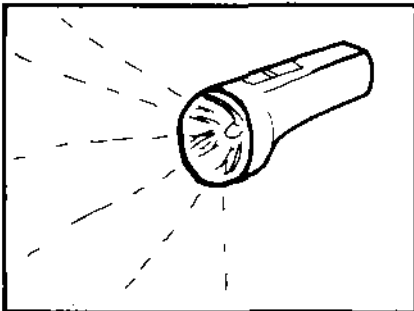

CHECK OUT THE POWER

OBJECTIVES

The student will do the following:

1. Identify how the senses (feeling, hearing, and seeing) detect kinetic energy.
2. Describe the change detected when a given object displays kinetic energy.
3. Explain how a given object (matter) changes form as a result of kinetic energy.

SUBJECTS:

Science, Art, Creative Writing

TIME:

120 minutes, plus wait time

MATERIALS:

bulletin board; picture of light bulb; pieces of bark; red, yellow, and orange tissue paper; brown construction paper; silver thread; yellow yarn; straight pins; (optional) black thread (or wire) and 5 small beads; scented candle; matches; marshmallows; stiff paper (cardboard, tablet back, or file folder); blue construction paper for each student or group of students; scissors; cars (3 identical models); pictures of candles, of sun, and of cars; student sheets (included)

BACKGROUND INFORMATION

Energy cannot be seen, but we can observe what it does. It causes matter to move or stop, or change from one form to another. It can be detected by the senses of feeling, seeing, or hearing.

If something that is cooler than our skin touches us, we feel the coldness of the object. If something warmer than our skin touches us, we feel its warmth. Catch a ball someone has thrown; you feel the ball hit or push against your hand. The push that you feel is caused by the energy of the moving ball.

The sense of vision contributes to our experiences of energy. Light is a form of energy. Most of what we know about the world around us is brought to us in the form of light messages that enter our eyes. The sun supplies energy to our earth. It gives us daylight and provides the energy needed by all living things. Without the sun, the earth would be so cold that no plants, animals, or people could survive.

Any time we hear sound, we know energy has been displayed. Any material will transmit sound, but materials vary in their sound-conducting qualities. Sound usually travels more readily through solids than liquids or gases.

Terms

detect: to discover or perceive.

energy: the ability to do work.

kinetic energy: the energy of motion (or heat or light).

matter: anything that has mass and takes up space; everything is either matter or energy.

potential energy: stored energy.

PROCEDURE

I. Setting the stage

A. Put the following questions on the board:

1. What is energy? (the ability to do work)
2. What work does energy do? (It moves or stops objects, or changes matter from one form to another.) Suggestion: Throw a ball to demonstrate the idea.
3. How can we detect or discover energy? (Energy can be detected by seeing, hearing, or feeling its results.) Suggestion: Throw the ball again to illustrate the use of our senses.

B. Develop an energy bulletin board to illustrate various demonstrations of energy and to introduce the students to ways in which energy can be detected.

1. Divide the students into four (or five) groups, and have them prepare the bulletin board. The optional fifth group is to cover nuclear energy. (Allow ample time for this activity.)
2. Give each group a copy of the student sheet "ENERGY BULLETIN BOARD," included. Assign each group one of the energy uses or forms listed on the student sheet, and give each group the listed materials. (If "nuclear" is appropriate for your students, use the items designated "optional" on the list of materials.) After they have completed making the figures for the board, fasten the figures to the board with straight pins.
3. When the board is completed, ask the students the following questions:
 - a. On the bulletin board, do you see representations of kinetic energy? (lightning, electric light bulb, water wheel, fire, and [if appropriate for your students] nuclear)
 - b. How can you detect the energy? (You can detect the light turned on, the fire giving off heat, water moving the wheel, and so on.) How do you use your senses to detect the movement? (See the lightning; see, feel, and hear the fire; etc.)
 - c. How could you stop this energy? (Turn off switch to light bulb, put out fire, break circuit, etc.)
 - d. Can you find an example of matter changing from one form to another? (One example is wood changing to ashes.)

4. Give each student a copy of the student sheet "ENERGY AT WORK," included. Ask if the students see signs of energy. What movement due to energy do they detect? Which senses detect the movement due to energy?
5. Tell the students they are going to play a game called "I Spy." They will look around the room and find objects that have potential energy. Each student is to think of a clue and ask the class to guess what object he/she is talking about. (Example: When energy is supplied to me, I make it possible for you to be able to see in the dark. What am I? [lights] I keep you warm on cold days. What am I? [heater])

II. Activity

- A. Reinforce the concepts that energy can be detected through our senses, and when matter moves, stops, or changes form, it is because of energy. You will need the following materials—a scented candle, matches, and a marshmallow. (You may want to divide older students into small groups for this activity.)
 1. Light a scented candle and let the students observe it burning for a few minutes. (WARNING: If the students are working in groups, you should closely supervise the use of matches.) Ask the students to explain how they know energy is present. (They can smell the scent, see the flame, and feel the heat.) Extinguish the candle.
 2. Re-light the candle. This time have the students observe the change in energy. (The energy display stopped when you blew the candle out and started again when you re-lit it.)
 3. Hold a marshmallow over the flame until it begins to melt. Ask the students to describe a change in matter because of energy. (Energy caused the marshmallow to change forms.)
 4. Add a picture of a candle to the Energy Bulletin Board.
- B. Discuss with the students how we detect energy from the sun. (We can feel the warmth, get a sunburn, use its light, feel it when we sit on metal that has been out in the sun, and so forth.)
 1. Give each student a copy of the student sheet "FUN IN THE SUN" (included), a piece of blue construction paper, a piece of stiff paper, and access to scissors.
 - a. Tell the students to follow the instructions on the student sheet. (Papers could be placed in areas having different light intensities. If space is limited, use this as a small group activity.)
 - b. Have the students check the results every day until the exposed portion of the blue paper has faded. (Allow about one week for results. Students could do Activity C. while waiting for results.)
 2. When the exposed paper has faded, tell the students to compare the exposed blue paper with the unexposed portion, and ask the following questions: What do you observe? (Fading.) Why do you think this is happening? (The sun's energy must do it.) What other changes occur because of the sun? (Some examples are that plants grow, we are warm, and we can see better.) What might happen if we didn't have the sun? (Accept any reasonable answer.)

3. Add to the Energy Bulletin Board a picture of the sun.
- C. Set up three identical "cars" on ramps (strips of cardboard) positioned at different angles to the table top. Ramp #1 should be raised one inch at one end; Ramp #2 is to be raised two inches at one end; and Ramp #3 is to be raised three inches at one end.
1. Tell the students there is going to be a car race, and they are to predict which car will reach the "finish line" first.
 2. Ask three students to position the cars at the tops of the ramps. At the signal, they are to release the cars. (Demonstrate the procedure with one car. The race can be held several times, with different cars being positioned on different ramps.)
 3. Discuss with the students the following questions: When did the cars have potential energy, and when did they have kinetic energy? (When they were held, they had potential energy. When they were released, they had kinetic energy.) What was the observable result of kinetic energy? (Movement.) What senses were used to detect kinetic energy? (Seeing, hearing.)
 4. **Important:** Ask the students what they can **infer** from observing the differences in the speeds at which the cars traveled.
 5. Ask the students what else would increase in speed if it were released from a higher level? (Lead the students to a discussion of water being poured into glasses held at various distances from a pitcher. This will help the students later when they encounter the use of hydroelectric dams as a means of producing power.)
 6. Have the students add a picture of a car to the Energy Bulletin Board. At this point, perhaps the students would like to give a title to the board.

III. Follow-up

- A. Give the students the appropriate part(s) of the student sheet "CHECK OUT THE POWER," included.
- B. Answers are as follows:
 1. see—light, change in form
feel—heat
hear—sound
 2. candle—gives light and feels warm
car—moves, makes sounds, gives light, and feels warm
falling water—moves and makes sounds
 3. When a candle burns, it becomes smaller (the solid becomes gas), and the wick also becomes smaller. Some of it turns black (carbon). When ice is warmed, it becomes water (liquid).

RESOURCES

Blough, G. and J. Schwartz. Elementary School Science and How to Teach It. New York: Holt, Rhinehart & Winston, 1974.

Carin, A. and R. Sand. Teaching Science Through Discovery. Columbus, OH: Charles E. Merrill, 1985.

Smith, H., M. Blecha, and H. Pless. Modern Science. River Forest, IL: Laidlaw Brothers, 1972.

The Book of Popular Science, Vols. 5 and 8. Canada: Grolier, 1976.

ENERGY BULLETIN BOARD

Water Wheel

1. Cut a water wheel from the brown construction paper.
2. Use silver thread for water.

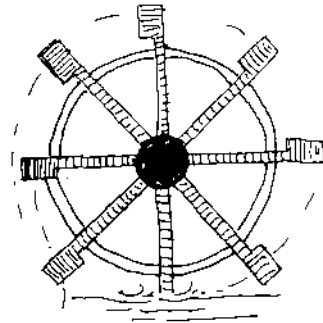

Fire

1. Use pieces of bark for wood.
2. Use red, yellow, and orange tissue paper for flames.



Light Bulb

1. Cut out a picture of a light bulb.
2. Use yellow yarn to show that the light is "on."

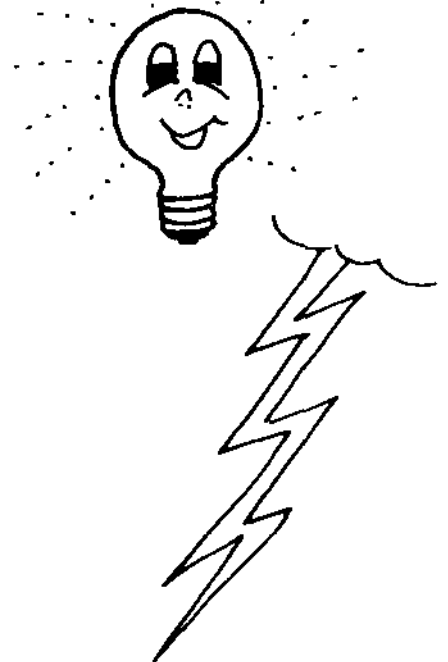

Lightning

1. Cut strips of yellow tissue paper.
2. Fold them into shapes for lightning.

Nuclear (if appropriate)

1. Cut 4 equal lengths of black thread.
2. Put 1 bead on each thread.
3. Tie the ends of each thread together in a small knot.
4. Use 1 bead for the center.

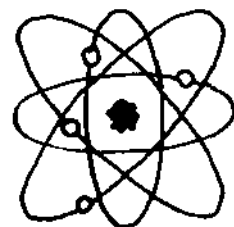

ENERGY AT WORK



FUN IN THE SUN

1. Cut a shape out of the stiff paper. (Make it different from everyone else's shape!)

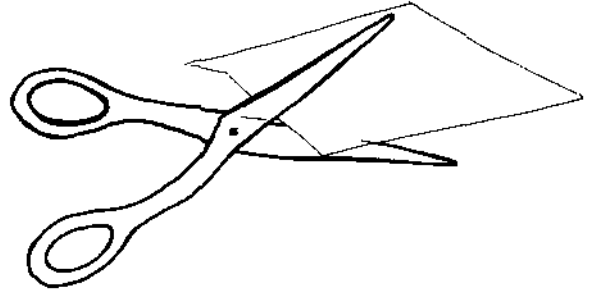

2. Write your name on the shape you designed.

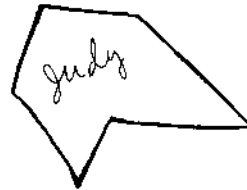

3. Put your design on the blue paper.

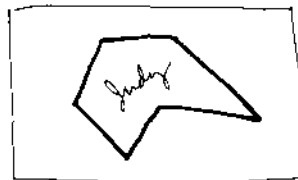

4. Put the paper and design in a place where there is sunlight.

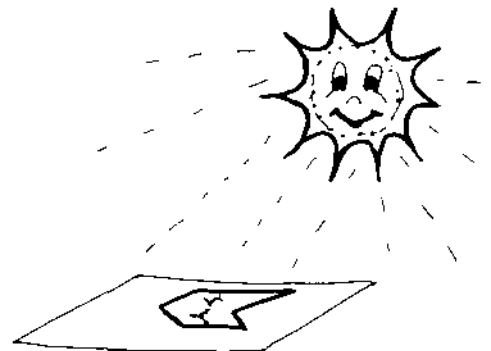

CHECK OUT THE POWER

1. Match the sense with the way it detects energy.



see

sound

feel

light and change in form



hear

heat

2. Fill in the blank using the words listed here. You may need to use two, three, or all four for your answer.

gives light

moves

feels warm

makes sounds

A candle _____

A car _____

Falling water _____

3. How do these objects change form as a result of kinetic energy?

Burning candle: _____

Warmed ice: _____

WHAT MAKES IT WORK?

OBJECTIVES

The student will do the following:

1. Identify the ways in which given devices display energy usage (heat, light, or movement).
2. Describe the sources of energy (electrical, chemical, mechanical, or solar) utilized by energy-using devices.
3. Trace the flow of energy in a given energy chain.

SUBJECT:

Science

TIME:

90 - 100 minutes

MATERIALS:

magazines; popcorn; hot plate, oil, and pan (or hot air corn popper); student sheets (included)

BACKGROUND INFORMATION

We rely on devices to supply us with light, heat, and movement. These devices utilize many different forms of energy, such as mechanical, solar, chemical, electrical, and nuclear. The flow of energy through these devices results in heat, light, or movement.

Many devices use a combination of these energy forms. A car uses chemical, mechanical, and electrical energy. Whether through single or combined forms of energy, we benefit from the use of energy. We warm and light our homes and offices; we have transportation; and we use energy in all the industries that provide us with goods and services.

Terms

chemical energy: energy stored in matter simply because of its composition; energy that is released when compounds change; e.g., the energy stored in fuel.

device: a thing used for a specific purpose.

electrical energy: energy produced by electrons moving through wires.

mechanical energy: the energy possessed by the moving parts of machines .

nuclear energy: the energy released when the nuclei of uranium atoms are split.

solar energy: a type of kinetic energy (more precisely called radiant energy), much of which is observable as visible light.

PROCEDURE

I. Setting the stage

- A. Quietly walk around the classroom and turn the lights on and off, trim a pencil in the pencil sharpener, warm your hands in front of the heater or cool them in front of the air conditioner, turn on the television, or do any other activity that demonstrates devices using energy.
 1. Ask the students the following questions:
 - a. What did I use that depends on energy to work?
 - b. How was the energy displayed? (By light, heat, and/or movement.)
 2. Define energy as the ability to do work; the work is displayed through heat, light, and/or movement.
- B. Share with the students the following information. Devices that use energy display heat, light, and/or movement. (Having examples of some devices in the classroom would add interest to the activity.) Different forms of energy are used to make these devices work. Some forms of energy and examples of their uses include the following:
 1. Chemical energy (Stored in batteries or in fuel; displayed by heat, light, and/or movement.)
 2. Mechanical (Used in key-wound alarm clocks; displayed by movement.)
 3. Electrical (Used in lamps and displayed by light and heat. Also used in electric heaters and displayed by light and heat.)
 4. Nuclear (Used in nuclear power plants to make electricity; displayed by heat, light, and movement.)

II. Activity

- A. Play the game "Energy ABC."
 1. Beginning with the letter "A" and going through the alphabet, have the students act out devices that use or display energy, such as "A—air conditioner," "B—bus or blender," "C—car," and so forth. You may have to help some students think of devices.
 2. As each device is named, discuss how its energy use is displayed. (By heat, light, movement, or any combination of the three).
 3. Have the students draw or find pictures of five of the devices they listed—one device each for heat, light, and movement, plus two that display more than one of these.
- B. Give each student a copy of the student sheet "ENERGY DIARY," included.
 1. Together with the students, list every energy-using device a person normally uses during one day. Have the students list the devices in the order in which they use them during the day.

- Discuss the lists, and help the students fill in the columns ("energy displayed" and "forms of energy") for the first items listed on their sheets. The diary might look like this:

| TIME | DEVICE | ENERGY DISPLAYED | FORMS OF ENERGY |
|-----------|------------------|------------------|------------------------|
| 7:00 a.m. | alarm clock | movement, sound | electrical, mechanical |
| 7:05 a.m. | lights | light (and heat) | electrical |
| 7:15 a.m. | hot water heater | heat | electrical |
| 7:30 a.m. | toaster oven | heat, light | electrical |
| 8:00 a.m. | bus | movement | chemical, mechanical |
| 8:15 a.m. | school bell | movement, sound | electrical, mechanical |
| 8:30 a.m. | pencil sharpener | movement | mechanical |
| 9:30 a.m. | calculator | light | solar |

- Have the students keep their energy diaries for 24 hours, returning them the following day.
 - Discuss the completed diaries.
- C. Tell the students that you are going to make popcorn. They are to use their senses to discover (observe) the forms of energy used and the kinds of energy displayed in the process of cooking and eating the popcorn. **CAUTION: USE ALL APPROPRIATE SAFETY MEASURES.** Discuss the process as you make the popcorn.
- Heat a hot plate or use a hot air popper. (Remind the students that electrical energy flowing through the hot plate results in heat and light.) Suggestion: On the board, draw an energy chain such as sun, rainfall, electricity, heat (this energy chain is for the water cycle and hydroelectric power generation and use).
 - Put a drop of oil into the pan (or use the air popper). Add 1 or 2 kernels of popcorn. Do not use a lid; wait for the kernel(s) to pop. (Heat flowing through the kernel results in movement.) Suggestion: On the board, add the movement (of the popping corn) to the energy chain.
 - Pop more corn (with a lid on the pan now, or in the air popper). While you are waiting for the corn to pop, discuss the flow of energy in this activity. Explain to the students that the flow of energy in this activity is like a chain in which energy is changed from one form to another.
 - When the popcorn is ready, let each student eat some.
 - Discuss with the students the chemical energy now being supplied to the body by the popcorn and the effects of that energy. (The chain is food, muscles, movement, work.)
 - Ask the students to think of other activities that involve chains of energy flow.

III. Follow-up

A. Use the following questions in a discussion:

1. How can we tell that energy is flowing through a device? (By sensing heat, light, and/or movement.) List some devices that use energy. (Accept all reasonable answers.)
 2. What are some forms of energy used by devices? (Some are electrical, chemical, mechanical, solar, and nuclear energy.) Name different devices that use each form of energy. (Accept all reasonable answers.)
 3. What are some devices that display kinetic energy in more than one way? (Some examples are electric heater—heat and light; car—movement, light, and heat; and electric drill—heat and movement.) What are some devices that use more than one form of energy? (A car, for example, uses mechanical, electrical, and chemical energy. (Accept all reasonable answers.)
- B. Following this discussion, have the students complete the student sheet "USING ENERGY," included. (Question 2. may require your help.)

Answers are as follows.

1. (a) heat (and light); (b) light, heat; (c) movement; (d) heat
2. cooking stove—elec.; bulldozer—mech., elec., chem.; television—elec.; microwave oven—elec.; water heater—elec.; car—elec., mech., chem.; pinball machine—elec.; calculator—solar, elec., or chem.; furnace—elec., chem.; radio—elec. or chem. (Because some stoves, furnaces, and water heaters burn fuels such as natural gas, some students may correctly answer "chemical energy" for these devices. Also, remember that batteries supply electricity from chemical energy.)
3. solar energy →plants→food→muscles→mechanical energy

RESOURCES

Energy Conservation Research. Energy for Today and Tomorrow. Wayne, PA: Author, 1979.

Fowler, J.M. Energy-Environment Sourcebook. Vols. 1 & 2. Washington, DC: National Science Teachers Association, 1975.

Prenis, J. Energy Book 2. Philadelphia: Running Press, 1977.

ENERGY DIARY

| TIME | DEVICE | ENERGY DISPLAYED | FORM(S) OF ENERGY |
|------|--------|------------------|-------------------|
| | | | |
| | | | |
| | | | |
| | | | |
| | | | |
| | | | |
| | | | |
| | | | |
| | | | |
| | | | |
| | | | |
| | | | |
| | | | |
| | | | |
| | | | |
| | | | |

USING ENERGY

1. How do these devices display energy? (heat, light, and movement)

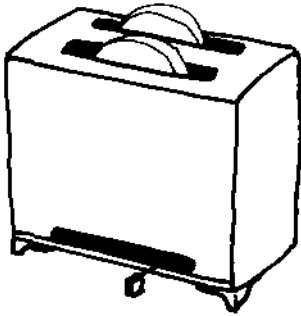

a. _____

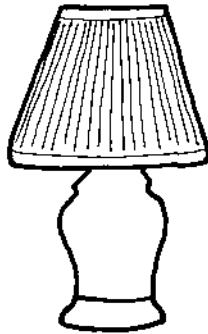

b. _____

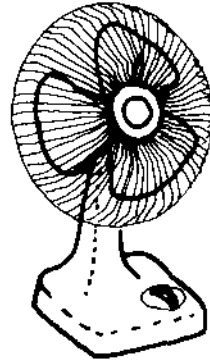

c. _____

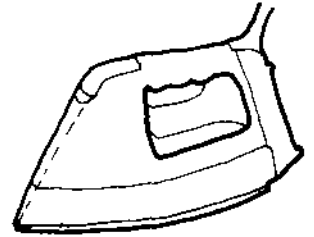

d. _____

2. Use these terms to describe the forms of energy used by the following devices.

electrical

chemical

mechanical

solar

cooking stove _____

car _____

bulldozer _____

pinball machine _____

television _____

calculator _____

microwave oven _____

furnace _____

water heater _____

radio _____

3. Use arrows to show how energy flows from the sun to the moving bicycle.

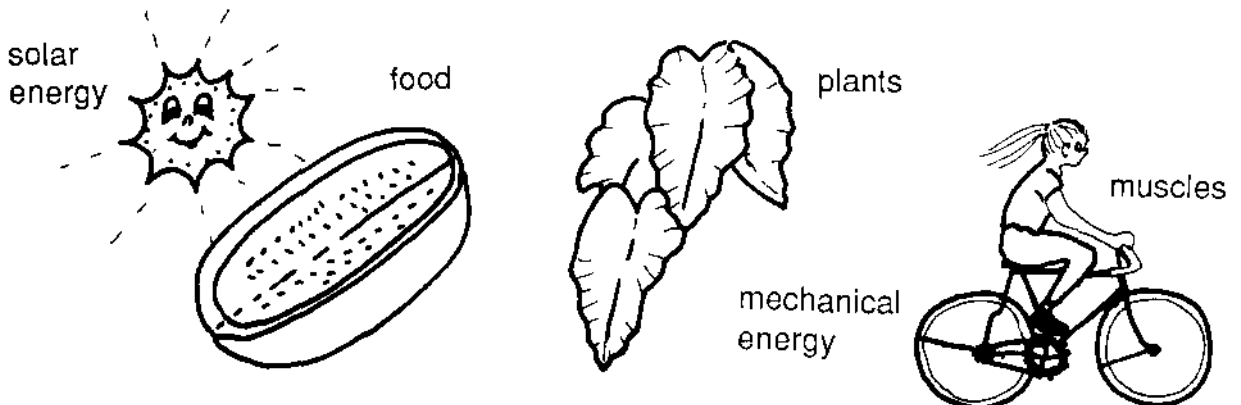

WE'VE GOT THE POWER

OBJECTIVES

The student will do the following:

1. Identify objects that use batteries as a source of energy.
2. Categorize objects according to the places they are used (e.g., home, school) and the type of energy they require (e.g., electrical, solar).
3. Explain the term "shaft power."

SUBJECTS:

Science, Math

TIME:

90-120 minutes, plus take-home activity

MATERIALS:

battery-operated flashlight, toy, and tape player; 3 batteries (1 dead, 1 weak, 1 new); cassette tape of energy-using devices (for example, cash register, electric mixer, clock ticking, school bell ringing, etc.); 6-V dry cell battery; electrical wire (2 pieces, each approximately 12" long); flashlight bulb; student sheets (included)

BACKGROUND INFORMATION

Human use of energy has accelerated over time because of the increase in human population and the development of technologies that use energy. This acceleration took on exponential proportions during the industrial revolution and has continued through the 20th century. The demand for energy rose as scientists and engineers developed new ways to use energy and even developed new energy resources.

Energy serves people in significant ways. It provides lighting, heating, and communications. We use it in the home, school, and workplace. We use it for cooking, entertainment, and transportation. We use energy in every area of our lives.

One of the most important uses of energy is providing shaft power by means of electric motors. Shaft power is the energy that drives the movable parts of motorized devices. There is a variety of such motors, with capacities that range from less than 1/100 of one horsepower to tens of thousands of horsepower. At least two dozen different motors are used in a typical home; they power clothes washers, dishwashers, refrigerators, vacuum cleaners, hair dyers, and other devices.

Terms

chemical energy: energy stored in matter (simply because of its composition) and released when compounds are changed; e.g., the energy stored in fuel.

electrical energy: energy produced by electrons moving through wires.

kilowatt: a unit of electrical power equal to one thousand watts.

mechanical energy: the energy possessed by the moving parts of machines.

nuclear energy: the energy that results when the nuclei of uranium atoms are split.

shaft power: energy transferred to the moving parts of a device by a shaft; for example, appliances have drive shafts that put their mechanical parts in motion by supplying energy to them from their electric motors.

solar energy: a type of kinetic energy (more precisely called radiant energy), much of which is observable as visible light.

watt: a measure of electric power; the product of amperes (flow) and number of volts (push).

PROCEDURE

I. Setting the stage

A. To explain the concept of energy from manpower, divide the class into small groups and assign a cleaning job to each. For example, have the students sort papers, straighten shelves, put materials away, and other tasks.

1. When they have finished, discuss how little time the task took because so many students shared the work.
2. Estimate how long it would have taken one student to do each of the same jobs.

B. Discuss the work done in terms of "units of student power."

II. Activity

A. Demonstrate the use of a good battery, a weak battery, and then a dead battery in a tape player or radio. Ask the students what made the difference in the way the device played. Explain to the students that a battery stores energy (potential energy) that can be used (as power) to make things work. Ask how batteries are like the units of student power in the activity above.

1. Show the students a battery-operated flashlight, toy, and tape player. Ask them what these have in common. (Batteries provide the energy.) Ask the students to list other things they use that require a battery. Try to elicit responses that cover the entire range of places in which we make use of things that use batteries (home, school, workplace, etc.).
2. Tell the students you will demonstrate changing the energy stored in a battery to electrical energy and then to light. (This may be done as a demonstration or in small groups.) Remove the insulation from both ends of two wires. Fasten one end of each wire to one of a 6-volt dry cell battery's terminals.
3. Using a flashlight bulb, hold the bare end of one wire tightly against the metal side of the light bulb. Hold the bare end of the other wire tightly against the little tip at the bottom of the bulb. What happens?

- B. Ask the students to pretend they are taking an imaginary trip down a busy street. Give them five minutes to write down all of the energy-using things (street lights, cars, time and temperature sign, etc.) they might encounter. When they have finished, list their responses on the board.
1. Play the previously recorded cassette tape of devices as they are using energy. After listening to the tape, make a list on the board of all the activities the students could identify and the energy-using devices involved in them.
 2. Ask the students to identify where they might find each device (school, home, office, street, or other places).
 3. Have the students determine the source of energy (mechanical, electrical, etc.) for each device.
- C. Explain to the students the term "shaft power." For a definition, see "Terms." As a take-home activity, have the students inventory the places in which we use energy from shaft-powered devices.
1. Divide the students into four groups, one each for school, home, work, and street.
 - a. Ask each group to inventory its place (e.g., school) for shaft-powered devices. Each student is to choose either heat, light, or movement and look for devices displaying energy in that way.
 - b. Give each student a copy of the student sheet "WHERE'S THE SHAFT POWER?" (included), and ask them to bring their completed lists back to class. They are to list only those objects they see.
 2. Compile a class list from the groups' lists, and discuss it. (Suggestion: Make a chart from the listing.)
 3. Ask the students what other sources of energy there are that are not included. (Two examples are wind and sun.) Where do we use those sources? How are they used?

III. Follow-up

- A. Review with the students the use of batteries in school, in the home, in the workplace, and on the street.
- B. Give each student a copy of the student sheet "WE'VE GOT THE POWER," included.

Answers are as follows:

1. radio, flashlight, tape recorder
2. a. school, home, office; b. school, office, home; c. school, home, office; d. street, home, school; e. electrical; f. solar (or chemical, if battery-powered); g. electrical; h. mechanical
3. Energy that is transferred by a shaft from a device's motor to its moving parts.

IV. Extension

- A. Find out the cost of a battery and the average life of that battery for a certain use. Calculate the cost per unit of time (days, weeks, or months).
- B. Leave a flashlight on to show how a battery runs down, resulting in a dimmer light.

RESOURCES

Childcraft Encyclopedia. Vol. 9 - Science and Industry. Chicago: Field Enterprises Educational, 1961.

McGraw-Hill Encyclopedia of Science and Technology. Vol. 8. New York: McGraw-Hill, 1987.

ADDITIONAL RESOURCE

"GM Sunraycer" (videocassette). TelEd, Inc., 1988. (Address: 7449 Melrose Avenue, Los Angeles, CA 90046. One free copy available per school.)

WE'VE GOT THE POWER

1. Circle the objects that use batteries as a source of energy.

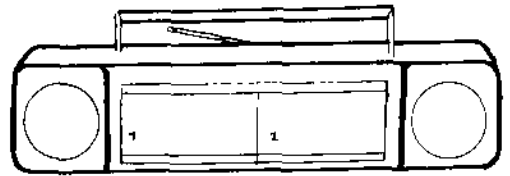
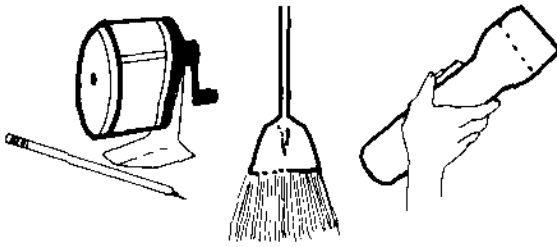
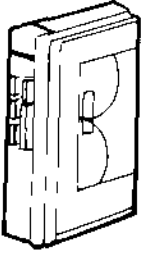

2. Answer the questions about each of these devices.

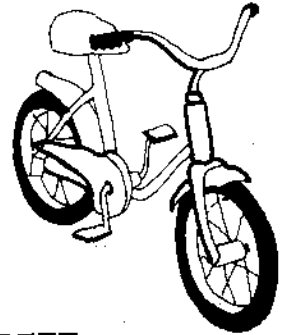
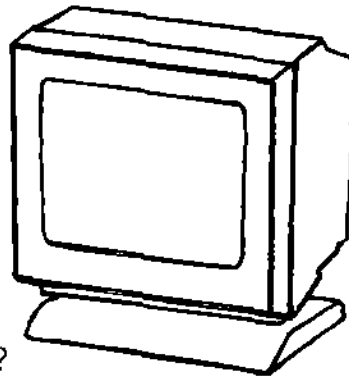
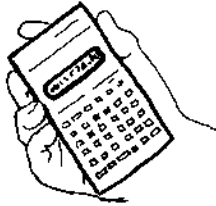
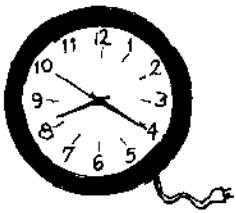

Where are each of these devices used?

HOME

SCHOOL

OFFICE

STREET

a. _____ b. _____ c. _____ d. _____

Which energy form is used by each device?

ELECTRICAL

SOLAR

MECHANICAL

NUCLEAR

CHEMICAL

e. _____ f. _____ g. _____ h. _____

3. What is shaft power?

READ ALL ABOUT IT

OBJECTIVES

The student will do the following:

1. Read temperatures on drawings of thermometers.
2. Identify the temperature ranges of various thermometers.
3. Calculate energy consumption in kilowatt-hours using a five-dial watt-hour meter reading.

SUBJECTS:

Science, Math

TIME:

90 - 120 minutes, plus take-home activity

MATERIALS:

various Celsius and Fahrenheit thermometers (e.g., oral, weather, candy, oven, meat), student sheets (included)

BACKGROUND INFORMATION

It is difficult for students to understand the concept of energy because so much of it is abstract. What is concrete is the way we use energy—lights come on when we flip light switches; ovens heat when we turn dials.

Students have heard the terms thermometer, temperature, and degree, but they need to understand the importance of these terms as they relate to energy. Students need to understand that there are instruments that perform the same function, but look different. Additionally, they need to understand the difference between Celsius (C) and Fahrenheit (F) measures of temperature, to know the abbreviations for these systems, and to be able to take temperature readings.

Students also need to become aware of energy consumption. By learning how to read a five-dial electric meter, students will be able to see evidence of energy consumption. Through the discovery process, they will understand how consumption can be reduced by simple energy conservation methods that are easily employed.

Terms

degrees: units of measurement of temperature.

kilowatt: a unit of electrical power equal to one thousand watts.

kilowatt-hour: a unit that measures the amount of electrical work done; the unit by which electricity is sold.

temperature: the hotness or coldness of something; a factor in determining the heat energy possessed by something.

thermometer: instrument used to measure temperature in degrees.

watt: a measure of electric power; the product of amperes (flow) and volts (push).

PROCEDURE

I. Setting the stage

A. Show the students an indoor/outdoor thermometer.

1. Ask the students the following questions (as suitable to their levels of understanding):
 - a. What is this instrument? (thermometer)
 - b. Why do we use this instrument? (to measure temperature)
 - c. Why is it important to know temperature? (to know how hot or cold something is)
 - d. What unit of measurement is used? (degree)
2. Review the definitions of thermometer, temperature, and degree.

B. Question the students about the following information. Temperature plays an important part in our lives. We need to be able to measure indoor and outdoor temperature so we will know the kind of clothing to wear. If we do not feel well, we take our body temperatures to see if we have fevers. A high fever can be very dangerous. We need to know the proper temperature at which some household appliances should be operated. For example, many foods have to be cooked at specific temperatures to cook properly; the freezer and refrigerator need to be set at cool enough temperatures to keep food from spoiling; and the water heater needs to be set at a high enough temperature to clean dishes, clothes, and us! Therefore, knowing how to read thermometers is necessary for us to live healthy lives.

II. Activity

- #### A. Draw on the board a diagram of a thermometer similar to the one you showed the students. Show them the numbers used for degrees and explain that on most thermometers, each line represents two degrees. On the thermometer, show them how the temperature is read at the point where the line of mercury stops. Transfer the reading from the thermometer to the diagram on the board.
1. Give the students who need help with reading thermometers a copy of the student sheet "READING A THERMOMETER," included. Explain to the students that these drawings represent parts of thermometers. Have them do the following:
 - a. Look at the point where the line of mercury stops.
 - b. Decide which of the two temperature readings is correct.
 - c. Circle the correct answer.
 - d. The temperature readings for thermometers #1 through #3 are different from that for thermometer #4. On thermometer #4, the mercury line stops between two lines. Tell the students that a reading halfway between two lines represents one degree.

Answers are as follows: 1. 26°, 2. 42°, 3. 64°, 4. 63°.

2. Give each student a copy of the student sheet "MORE THERMOMETERS," included. The first three problems allow the student to select the correct answer from a choice of two readings. In problems 4 through 8, the students are to read the thermometers and write the correct readings on the blanks.

Answers are as follows: 1. 48°, 2. 19°, 3. 53°, 4. 68°, 5. 64°, 6. 28°, 7. 68°, 8. 81°.

- B. Measuring temperature plays an important part in our daily lives. Students need to be exposed to various types of thermometers they will encounter.
1. Display a variety of types of Fahrenheit thermometers, such as an oral thermometer, a candy thermometer, an oven thermometer, and a meat thermometer. Identify each one, and compare each with the others.
 - a. oral thermometer - Most students have seen and used one of these. An oral thermometer has a degree span of about 16 degrees, but normal body temperature ranges are much smaller. Ask how body temperature would be affected if someone drank something hot or cold just before taking his/her temperature.
 - b. candy thermometer - Ask the students if they have seen one of these. For what use is it? The candy thermometer has a wide range of temperatures (e.g., 75 to 400 degrees Fahrenheit). Discuss what is meant by the different stages—such as soft-ball stage—indicated by the candy thermometer.
 - c. oven thermometer - Ovens have a temperature dial. Ask the students why an oven thermometer might be necessary. Discuss the oven temperature's degree range (100 to 500 degrees Fahrenheit).
 - d. meat thermometer - Ask the students if they have seen someone use this type of thermometer. Many kinds of meats are safe to eat only after they have been cooked to a specific temperature. Show the students the nail-like part that is inserted into the meat. The thermometer's scale is usually fairly small (e.g., 130 to 220 degrees Fahrenheit), and it commonly identifies the correct temperatures for several kinds of meat.
 - e. refrigerator/freezer thermometer - Ask the students if they have seen a thermometer like this. The temperature range is approximately -30 to 90 degrees Fahrenheit.
 2. Although Fahrenheit thermometers are used in the United States, Celsius thermometers are used elsewhere, as well as being used for scientific purposes in this country. Remind the students that there are different ways to measure the same thing. For example, we usually measure distances in inches, feet, yards, and miles. In the metric system of measurement, we measure distance in millimeters, centimeters, meters, and kilometers. Celsius and Fahrenheit are simply different ways of measuring the same thing—temperature.
 - a. Remind the students that Celsius and Fahrenheit are different scales of temperature; one degree Celsius is not the same as one degree Fahrenheit.
 - b. Show the students both a Celsius and a Fahrenheit thermometer. Have several students read each one. If each thermometer is measuring the same thing (the air temperature in the classroom), what can the students conclude about the two temperature readings? (The numbers of degrees are different on the two thermometers, but they are measuring the same thing; therefore, the two temperatures are equivalent.)

3. Tell the students that temperature is an indication of the heat energy in something. Temperature is not a direct measurement of heat energy, but it can help us determine how much heat energy something has. (Heat energy is measured in units called calories. Kilocalories, or "large calories," are the units in which the energy value of foods are given.)
- C. Although thermometers do not directly measure heat energy, some instruments do measure energy directly. Ask the students if they know how the amount of electricity a home, school, business, or other facility uses is measured. (Electric meters record electricity usage.)
1. Tell them that electric meters have numbered dials on which hands spin around as electricity is being used. Reading these dials tells how much electricity has been used. Utility companies employ meter readers to read the meters at homes and other places. These meter readings are used by the utilities to bill their customers.
 2. Show the class a sample electric bill. (Use the sample bill included. You may wish to copy it for the students or to make a transparency of it.) Indicate where the meter readings are given and where the total electricity usage is noted.
 - a. Explain to the students that, even though we can't see electricity, we use it in our houses all the time. Electricity is not free. People must pay for using it.
 - b. Define the terms kilowatt and kilowatt-hour for the students. Make sure they understand that electricity is purchased by the kilowatt-hour, just as gasoline is bought by the gallon or fresh fruits and vegetables are bought by the pound.
 3. Give each student a copy of the student sheet "READING A METER," included. Explain to the students that this drawing of a five-dial watt-hour meter represents the meters at their homes.
 - a. Explain that the dials follow a pattern (like place value) with numbers starting with units (on the right) and extending to ten thousands (on the left).
 - b. Note the order of the numbers around the dials. The numbers of some dials go in a clockwise direction, and some go in a counterclockwise direction. Note that the directions alternate.
 - c. Explain that the dial is a mechanical dial setting, and the hand reaches a higher number only when the next lower dial passes zero. For example, the tens dial will continue to read 40 until the units dial crosses 0. When the hand is between two numbers, the lower of the two numbers is the one to be read.
 - d. When the meter reads 99,999 and the units dial passes 0, the meter will "turn over" to 00,000—signifying 100,000. Point out to the students that automobile odometers work the same way.
 - e. Have the students determine the reading of the sample. Some students may need help filling in the blanks with the proper numbers. (The answer is 40,248.)
 4. Have the students work the problems on the student sheet "METER READER" (included) to reinforce the skill. (The answers are: (1) 40,138; (2) 57,892; (3) 25,246; (4) 64,752.)
 5. Continue to practice reading meters until the students have mastered the skill.

6. As a "take-home" activity, give the students copies of the student sheet "THAT'S LIFE," included. (If a student has no access to a meter, perhaps an adult from his/her home could accompany him/her to a neighbor's or relative's home, or perhaps he/she could see a meter elsewhere.) When the students have read a meter each day for a week, have them bring their student sheets back to class. Help them calculate the numbers of kilowatthours consumed in that week. Discuss their findings.

III. Follow-up

A. Review with the students the following:

1. The name of the instrument used to measure temperature. (thermometer)
2. The unit used for temperature. (degree)
3. Examples of thermometers that might be used in the home. (air temperature, candy, oven, meat, oral)
4. The purpose of an electric meter. (to measure energy consumption in kilowatthours, a figure used in determining the amount owed for the electricity used)

B. Give the students the appropriate part(s) of the student sheet "MEASURING UP," included. Be sure the students have become familiar with several different types of thermometers.

Answers are as follows:

1. (a) 70° , (b) 98.4° , (c) 250°
2. (a) $90 - 106^{\circ}$, (b) $-40 - 120^{\circ}$, (c) $130-220^{\circ}$
3. (a) 1st reading - 91479, (b) 2nd reading - 02350, (c) kWh used - 871

IV. Extension

- A. Have the students take air temperature readings (indoor or outdoor) throughout the day and plot them on graphs. Make charts of high and low temperatures. Investigate why mercury is used in thermometers and why other substances, such as water, are not used. There are thermometers that use substances other than mercury; what can the students find out about them?
- B. Discuss with the students the term freezing point. Set out a glass of water and ask the students to guess what the temperature of the water is. Use a thermometer to take a reading of the water temperature. Add an ice cube to the glass of water and ask what the temperature is. Use the thermometer to get a reading. Continue by adding several more ice cubes. Each time, have the students estimate the temperature, and then take a reading. Ask the students if they think enough ice cubes could be added to lower the temperature to the freezing point. Why, or why not? (Even though the ice is frozen water, the ice cannot lower the temperature enough to freeze the water sitting out at room temperature.)

- C. Divide the students into small groups. Have them use paper or styrofoam cups, aluminum foil, paper towels, ice, hot water, and thermometers to do the following:
1. Make lists of things that are hotter and/or colder than a given object in the room or out of doors.
 2. Have an ice-melting race, using any means possible to make the group's ice cube melt faster than anyone else's. Discuss the results and the procedures used.
 3. Have an ice-keeping contest.
 4. Have a contest to see which group can register the lowest temperature on its thermometer (anything goes!).
- D. For an outside activity, have the students find and record the following temperatures:
1. The hottest place outside the building.
 2. The coldest place outside the building.
 3. The air temperature one centimeter above a sidewalk in the sun.
 4. The air temperature one meter above a sidewalk in the sun.
 5. Repeat 3 and 4 at an area paved with blacktop (e.g., a parking lot).
 6. In the front window of a car parked in the sun.
 7. On the seat of a car parked in the sun.

RESOURCE

Mallinson, G. G., J.B. Mallinson, D. G. Brown, W. L. Smallwood, and J. Knapp. Science: Understanding Your Environment. Lexington, ME: Silver Burdett & Ginn, 1981.

READING A THERMOMETER

1.

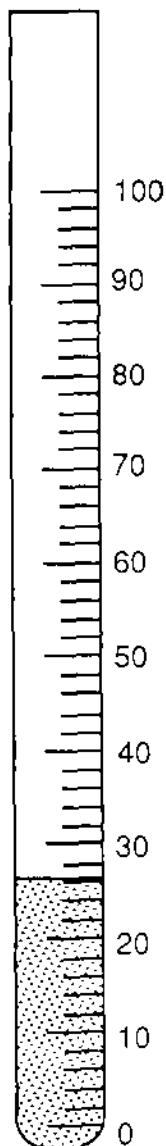
 38° or 26°

2.

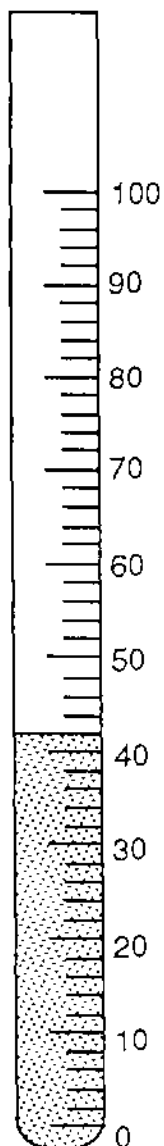
 42° or 58°

3.

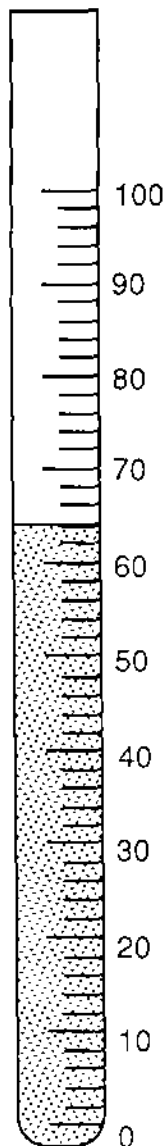
 76° or 64°

4.

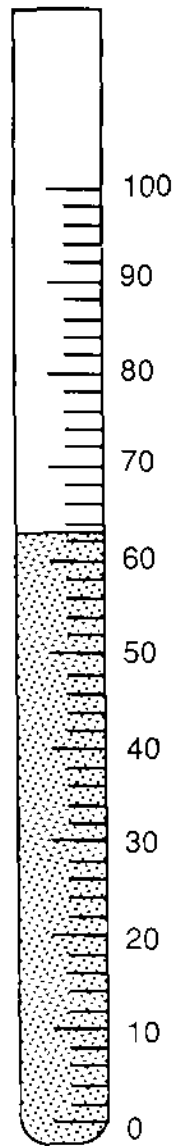
 63° or 77°

MORE THERMOMETERS

1.

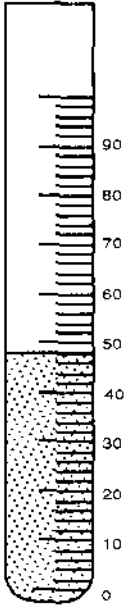

52° or 48°

2.

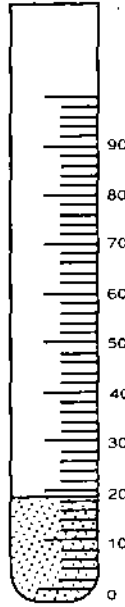

19° or 21°

3.

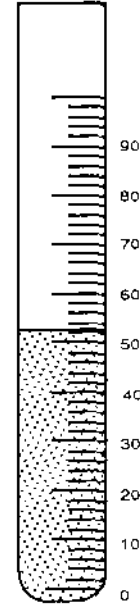

67° or 53°

4.

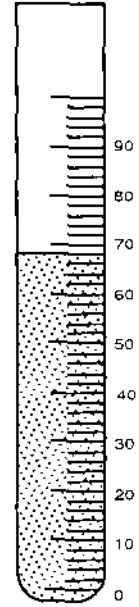

5.

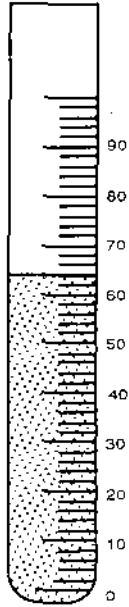

6.

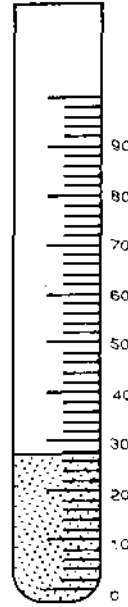

7.

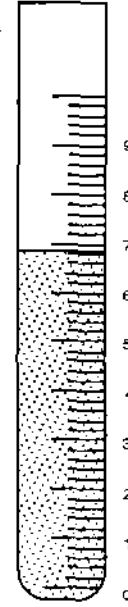

8.

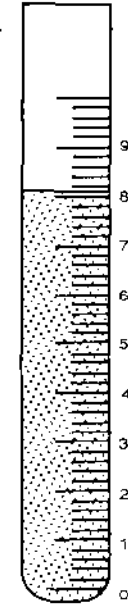

SAMPLE ELECTRIC BILL

Kilowatt Utilities Co.
 Faraday Drive
 P.O. Box 115/230
 Edison, TN 35454

K
U

I.M. Customer
 108 West Street
 Edison, TN 35454

BILL

| | |
|-----------------|-------------------------|
| DUE DATE | TOTAL AMOUNT DUE |
| Feb 25, 1988 | \$45.41 |

PLEASE RETURN ENTIRE BILL WHEN PAYING IN PERSON

| | | |
|--|---------------------------------------|------------------------------------|
| SERVICE ADDRESS I.M. Customer 108 West Street Edison, TN 35454 | ACCOUNT NUMBER 123456-789-0 | TOTAL AMOUNT DUE \$45.41 |
|--|---------------------------------------|------------------------------------|

| SERVICE | BILLING | | READ CODE | READINGS | | USAGE | CHARGES |
|-----------------------|---------|---------|--------------|----------|---------|-------|---------|
| | FROM | TO | | PREVIOUS | PRESENT | | |
| All Electric Resident | 1/15/88 | 2/15/88 | R | 91479 | 02350 | 871 | 45.41 |

| | COMPARISONS | | | |
|-------------------------|------------------------|--------------------|-----------|---------------------|
| | Average Temperature | Days of Service | Total kWh | Avg. kWh Per Day |
| | Current Billing Period | 30.9 | 27 | 871 |
| Previous Billing Period | 45.0 | 32 | 760 | 23.8 |
| Same Period Last Year | 35.0 | 32 | 732 | 22.9 |

CODES

R Regular Read
 U Verified Read
 E Estimated Read
 S Customer Read
 M Minimum Amount Applied
 CR Credit Amount

RATE EXPLANATION

A complete schedule of rates and regulations is available for inspection at your Kilowatt Utilities Company office. A copy is available upon request.

BUDGET PLAN

Kilowatt Utilities Company has a budget plan to help residential customers budget for the payment of their electric bills. The budget plan will be offered after a history of actual use has been established at your present address.

READING A METER

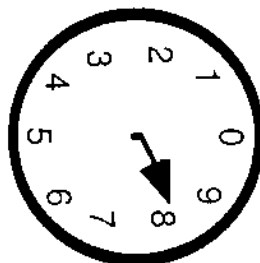
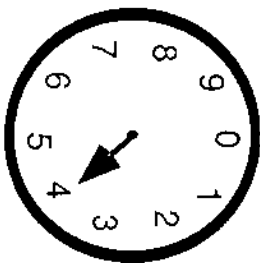
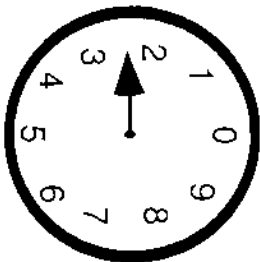
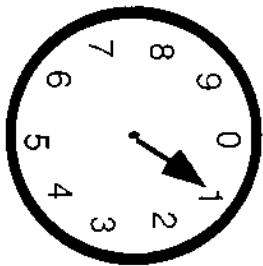
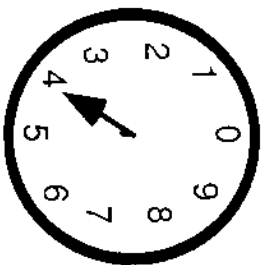

ten thousands

thousands

hundreds

tens

ones

METER READER

Directions: Draw a curved arrow on each dial to show the direction in which its hand is moving.

Read the dials from left to right. When the hand is between two numbers, read the smaller number.

Write the proper number in the blanks below the dials.

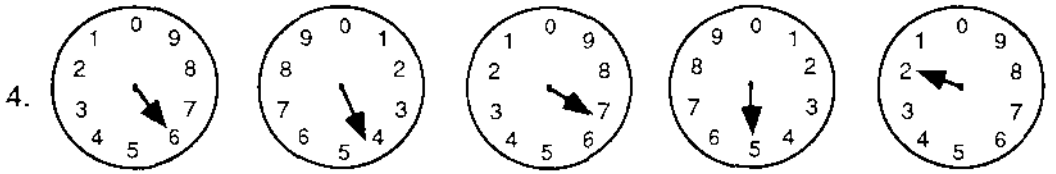
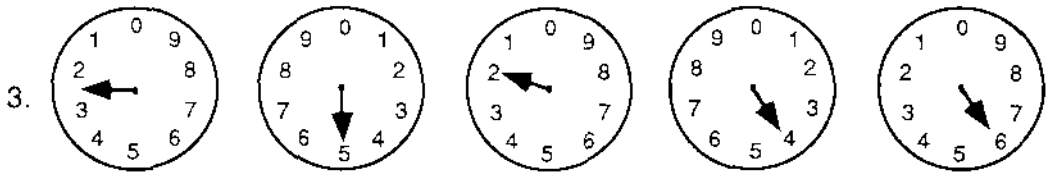
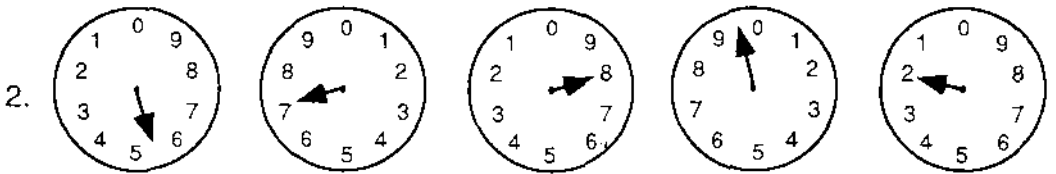
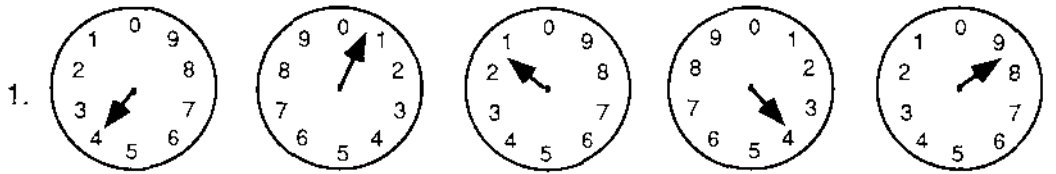

THAT'S LIFE

Electric Meter Reading - Sunday #1 _____

Read your meter each day for one week. Write each day's reading in the blank for that day.

Reading:

M _____

T _____

W _____

Th _____

F _____

S _____

Electric Meter Reading - Sunday #2 _____

To find out the total electricity usage for the week, do the following:

1. Write the Reading for Sunday #2 _____

2. Subtract the Reading for Sunday #1 - _____

3. Number of kWh used _____

MEASURING UP

1. Fill in the blanks with the thermometer readings.

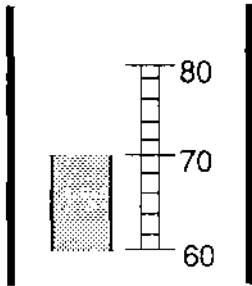

a. _____

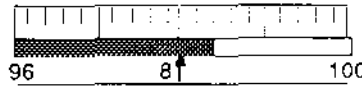

b. _____

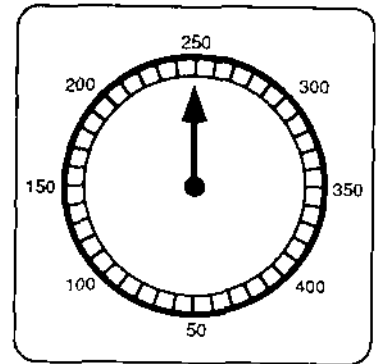

c. _____

2. Write the temperature range for each kind of thermometer on the answer line.

-40° - 120°

90° - 106°

130° - 220°

a. oral _____

b. air _____

c. meat _____

3. How many kWh were used?

a. 1st reading



b. 2nd reading

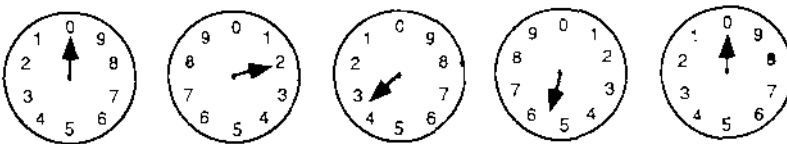

c. kWh used

SPREADING THE HEAT AROUND

OBJECTIVES

The student will do the following:

1. Define the terms convection, conduction, and radiation.
2. Distinguish between heat transfer by conduction, convection, and radiation.
3. Classify given objects as good or poor conductors of heat.

SUBJECT:

Science

TIME:

100 minutes

MATERIALS:

5 pennies (each with a different date); paper bag; soft drink bottle; small, thin balloon; burner; pan; water; bowl of ice; candle; match; hot water; pencil; soda straw; spoons (silver, plastic, stainless steel); student sheet (included)

BACKGROUND INFORMATION

Heat is one result of kinetic energy—the energy of movement. The molecules of every substance are moving; even those making up solid substances are constantly in motion (although the range of that motion is much smaller than for liquids or gases). When a substance is “hot,” its molecules are moving about very rapidly. When a substance is “cold,” its molecules are moving less rapidly.

There are three ways heat energy can move from one place to another—conduction, convection, or radiation. Conduction is a method of heat movement in which energy is transferred from molecule to molecule as they collide or bombard each other. It is the movement of heat through a solid material, such as when one end of a metal object is held in a flame, and the other end becomes warm or hot. In convection, the transfer of heat is accomplished by moving currents of heated matter. It is the movement of heat through a liquid or gas, such as when running hot water into the bathtub helps to warm the cooler water already in the tub. The transfer of heat by radiation is unique in that no heat-transferring substance is necessary; an energy wave called infrared radiation transfers the heat energy. This is the way the sun warms the earth; there is no solid, liquid, or gas between them to conduct the heat. Infrared rays should not be thought of as heat energy itself. The rays produce heat only when they strike substances and cause the movement of their molecules to speed up.

Terms

conduction: the transfer of heat energy within substances or objects as their molecules collide with increasing energy, spreading heat energy throughout them.

conductor: a substance or body capable of transmitting heat (also used for a substance or object capable of transmitting sound, or electricity).

convection: the transfer of heat energy due to the movement of currents of heated gas or liquid; for example, warm air rises and cool air sinks, creating an air flow pattern.

insulator: a material that resists the flow (is a poor conductor) of heat energy and is used to prevent undesired heat flow.

radiation: the transfer of heat energy by invisible waves (in the infrared range); not the same as nuclear radiation (high-energy particles and/or waves given off when the nuclei of atoms change).

PROCEDURE

I. Setting the stage

- A. Put the five pennies in the paper bag and keep it in a very cool place until time for the lesson. Ask the students to raise their hands if they like magic tricks.
 1. Ask one student to read the date on each penny. Then ask another student to reach into the paper bag and pull out one penny. Tell the student to memorize the date on the penny and pass it on to each student in the class to examine carefully. They are not to say the date aloud!
 2. After each student in the class has looked carefully at the coin and has memorized the date on it, have them return the penny to the paper bag. Tell them you will show them the same penny. Reach in and pull out the penny they chose. (Secret: Copper is a good conductor of heat. The penny your students handled will be much warmer than the other pennies. You simply pull out the warmest penny.)
- B. Explain to the students that when heat is transferred from one object to another (for example, from fingers to penny), heat energy is conducted. Show the students the top section of the student sheet "SPREADING THE HEAT AROUND," included. Ask the students to think of other times when heat is conducted—transferred from one substance or object to another.

II. Activity

- A. When air is heated, some changes take place. Ask the students if they can discover some changes:
 1. Place a pan of water on a burner and bring the water to the boiling point. **CAUTION: OBSERVE ALL SAFETY MEASURES.**
 2. Place a balloon over the mouth of an empty soft drink bottle. Place the bottle and the balloon in the pan of boiling water. What happens to the balloon? (It expands.)
 3. Next, place the bottle in a bowl of ice. What happens to the balloon? (It contracts.)
 4. Explain that when air is heated, it expands. When air is cooled, it contracts. Show the students the center section of the student sheet "SPREADING THE HEAT AROUND." Tell the students that something similar to what happened in the soft drink bottle happens in a room when heat is transferred by convection. The air that is warmed expands and rises, while the cooler air sinks. Over and over again, air keeps moving in a loop around the room; the warm air rises and the cool air moves down to the floor. The warm air transfers heat to objects in the room, and the cooler air circulates to the heater. In this way, the heater or radiator can heat the whole room. The same circular motion happens in water being heated. Give the students other examples of convection taking place in liquid (such as the previous bathtub example) and explain the process.

5. Ask the students to think of other examples of convection and to explain the process in their own words. (Some students may need help with this.)
- B. Ask the students how a fire in a fireplace can warm us without our touching it or without our waiting for it to warm the air in the room. Let the students suggest how this might occur. Perform this demonstration:
1. Observe an unlit match and candle. Do they glow? (no) Do they give off light and heat? (no)
 2. Light the candle. Does the candle give off heat and light after its wick is ignited with the match? (yes) Have several students hold out their hands to feel the warmth from the candle. **BE VERY CAREFUL!** Ask them if it is hotter above the candle, or to the side of the candle? (above) The air above the candle is heated by convection, so the students feel both the warmth of the air and the warmth radiated by the candle's flame. When the hand is beside the flame, the hand is warmed by radiation. Show the students the bottom section of the student sheet, "SPREADING THE HEAT AROUND." Radiation is illustrated.
 3. Ask the students why people use fireplaces to heat their homes. (Accept all reasons.) Tell the students that although many people use fireplaces to help heat their homes, in many cases more heat is lost up the chimney (through convection) than is **radiated** into the room.
- C. Tell the students that we do many things without thinking about the reasons we do them. For example, why do we wear certain types of clothes in the winter and other types of clothes in the summer? (Winter clothes keep us warmer; summer clothes, cooler. Some materials keep body heat in; others let body heat out.) Explain that not all materials conduct heat equally well. Review the definition of conduction. Generally, metals are better conductors than nonmetals. Liquids, gases, wood, and nonmetallic solids that are poor conductors of heat are called insulators.
1. Tell the students that we are going to test some materials to see if they are good or poor conductors of heat. Have available a pencil, a silver spoon, a stainless steel spoon, a plastic spoon, a soda straw, and a pan of hot water. **CAUTION: OBSERVE ALL SAFETY MEASURES.**
 - a. Have the students take turns holding part of each item in the pan of hot water. Their fingers will sense which items conduct heat quickly and which ones do not.
 - b. Have the students group the objects according to whether they are good or poor conductors. Ask them to identify which objects would or would not be considered insulators.
 2. Ask the students how they were able to group the items. For the group of items classified as "good conductors," what did they feel? Can they explain why? (The objects became hot. Heat was transferred through the objects until they were the same temperature as the water.) Why was it important to keep the water the same temperature throughout the experiment? (All of the objects should be subjected to the same amount of heat during the investigation.)

III. Follow-up

- A. Ask the students to define convection, conduction, and radiation. (You may want to write their definitions on the board.)
- B. Give the students a list of situations (e.g., baking a cake, sitting outside in the sunshine) in which heat is transferred, and ask them to decide in which of the three ways heat is transferred.
- C. Give the students a list of materials and ask them to classify them as "good" or "poor" conductors of heat (e.g., copper, plastic, wood).

IV. Extension

- A. Ask the students to consider what they learned from the experiment about good and poor conductors. Why do people insulate their homes? (To keep warm air in and cold air out, or cool air in and warm air out.) Have them research the subject, finding out what materials are good for insulating homes and listing ways we can prevent heat loss from our homes during the winter months and prevent heat gain in the summer months.
- B. Arrange for the school custodian to guide the class on an in-school "field trip" to observe the school's heating plant. Tell the students to be looking for the answers to questions such as: What fuel is used in the furnace? How does heat travel to the classrooms? How is heat loss prevented?

RESOURCES

Blough, G., and J. Schwartz. Elementary School Science and How to Teach It, 5th ed. New York: Holt, Rhinehart, & Winston, 1974.

Schneider, H., and N. Schneider. Science: Far and Near, 3rd ed. Boston: D.C. Heath, 1968.

Smith, H., M. Blecha, and H. Pless. Modern Science. River Forest, IL: Laidlaw Brothers, 1972.

SPREADING THE HEAT AROUND

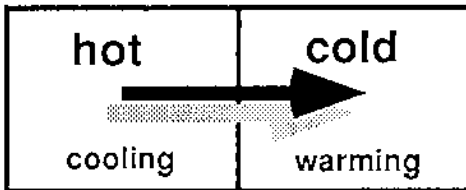
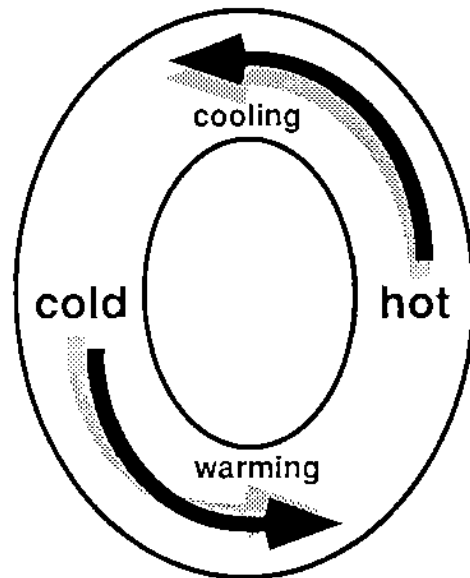
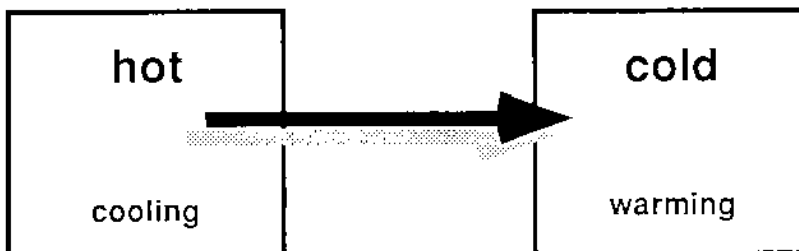
CONDUCTION**CONVECTION****RADIATION**

LIGHT ON YOUR FEET

OBJECTIVES

The student will do the following:

1. Recall the speed of light in miles per second.
2. Describe refraction.
3. Explain the causes of refraction.

SUBJECT:

Science

TIME:

90 minutes

MATERIALS:

tape measure, stopwatch, chalk or tape, obstacle course items (such as pylons, hurdles, tires, etc.), glass of water, pencil

BACKGROUND INFORMATION

Light travels faster than 186,000 miles per second. A speed that high is difficult to comprehend. Comparing this speed to familiar, everyday speeds helps students better understand how quickly light travels.

Students also need to understand that light speed changes as it travels through different substances, and that light waves bend when they pass from one medium to another. Refraction (the bending of light) can be used in many ways. Refraction aids us in our daily lives through the use of lenses in eyeglasses, telescopes, binoculars, and microscopes.

Term

refraction: the bending of a wave (such as light) as it passes from one medium into another (e.g., passing from air into water).

PROCEDURE

- I. Setting the stage
 - A. Tell the students to wear running shoes for a race. To do the activity, take the students outside, if possible, or to the gym.
 1. Mark off a course 100 feet in length; use chalk or tape.
 2. Have the students run that distance as quickly as they can. Use a stopwatch to time them. Let them run the course a second time to try to beat their first times. Record their fastest times. (OPTION: Have them run in small groups.)
 - B. Choose an average time for running the 100 feet. Divide the distance by the time. For example, if an average time was 10 seconds, divide 100 feet by 10 seconds. The average speed is then 10 feet per second ($100' \div 10 \text{ sec.} = 10' / \text{sec.}$). Mark off the distance run per second so the students can see what the distance (10 feet) looks like.

II. Activity

- A. Explain to the students that light travels at a very high rate of speed—186,000 miles per second. Help the students compare that distance with their average speed.
1. To help the students visualize the distance, choose a nearby city that they may frequently visit. For example, a frequently visited town might be 50 miles away. Divide 186,000 miles by the mileage to the designated city (50). Explain to the students that this figure represents the number of times light would travel to that city in just one second. (In this example, the number is 3,720 times.)
 2. Work with the students to calculate the time it would take to drive (at 60 miles per hour) the number of times the light would travel to the city in one second. In this example, (3,720 times x 50 miles or) $186,000 \text{ miles} \div 60 \text{ mph} = 3,100 \text{ hours}$, or ($\div 24$) 129.17 days, or ($\div 7$) 18.45 weeks, or ($129.17 \div 30$) 4.31 months!
- B. Divide the students into groups of about four members each. Explain that they are going to run again, but this time fast speed is not as important as constant speed. It is necessary that they be as consistent as possible.
1. Mark off four straight running lanes of 100 feet each. Have each member of the four teams run the distance; record their times. Have the students run the distance a second time, trying to be consistent with the first recorded time. Show them the differences in their first and second times.
 2. Explain that light travels in a straight line and at a consistent rate of speed until it strikes something or passes into a different medium.
 3. Set up some obstacles in the running lanes—pylons to run around, objects to crawl through, and objects to jump over. Have the students run the obstacle course. Record their times, and compare their times with the previous runs.
 4. Explain that when light rays pass from one medium into another, their paths are “bent.” This is called refraction.
- C. Explain that just as the students had to slow down and make bends in their last run, light has to do the same thing when it passes from one material to another.
1. Ask the students to recall if each obstacle slowed their speeds at the same rate. If not, which ones slowed their travel the most?
 2. Put a pencil in a glass of water, and let the students observe the change of appearance where the pencil enters the water. Ask them if they have tried to catch fish in a fishbowl, or in a pond or stream, and found that the fish are not where they appear to be. Why do they think this happens? (Light travels in straight lines, but when it travels from one material to another its direction is changed somewhat). When the light changes direction—or bends—it is called refraction.
 3. Manmade objects, such as lenses and optical glasses helps us see things better or see things we cannot see at all without them. Telescopes help us to see far-away objects by enlarging their image. The control of refracted light by the use of lenses allows us to concentrate light and even increase the amount of heat applied to a given area. (For example, magnifying glasses can start fires when they concentrate light.) This may be useful in energy technologies of the future.

III. Follow-up

Use the following questions as the discussion:

- A. About how fast does light travel? (186,000 miles per second)
- B. In what kind of path does light usually travel? (straight lines)
- C. What happens when light passes from one material into a different material? (The light's speed decreases and its waves bend.)
- D. What is the term for the bending of light? (refraction)

RESOURCE

Holmes, N. J., J. B. Leake, and M. W. Shaw. Gateway to Science - 5th Grade Edition. New York: Webster Division, McGraw-Hill, 1983.

S. O. S. (SAVE OUR SOURCES)

OBJECTIVES

The student will do the following:

1. Distinguish between renewable and nonrenewable resources.
2. Develop a plan to conserve our nonrenewable energy sources.

SUBJECT:

Science

TIME:

150 minutes

MATERIALS:

pictures cut from magazines, reference materials on conservation, poster board, crayons or markers

BACKGROUND INFORMATION

There are only about five necessities for survival—food, clothing, air, water, and shelter. If we had only these five basics, our lives would be drastically different. We now view many of the conveniences and comforts of our modern lifestyles as basic needs!

There are many things that contribute to our lifestyles that we take for granted. For example, we seldom think of the resources that provide the energy we consume. For most people, energy is abstract; it is something that makes our lights glow and warms or cools our houses. It is important for people to be aware, however, that most of the energy we now consume is from finite resources that will not last forever; that is, they are not renewable. These nonrenewable resources are being consumed at an alarming rate.

The solution to the problem of our consumption of nonrenewable resources is two-fold. First, we must conserve our nonrenewable resources, and, second, we must increase our use of renewable sources of energy.

Terms

conserve: to use (a resource) wisely and efficiently.

fossil fuels: fuels from ancient, once-living plants and animals; coal, petroleum, or natural gas.

nonrenewable: not able to be restored or replenished.

recycle: to use a material again in a form similar to its original form; for example, newspapers can be recycled into cardboard, more newspapers, or other products.

renewable: able to be restored or replenished.

resource: a supply of a valuable or useful thing; something that can be used to make or supply something else.

PROCEDURE

- I. Setting the stage
 - A. Ask the students to list five things they must have to survive.
 - B. Discuss their responses, and categorize them according to these basic necessities—food, water, air, clothing, and shelter.
 1. Ask the students to compare their lifestyles now with those that include only things that are basic survival needs.
 2. Ask the students to examine each basic survival need closely. What would happen if one of those needs was not met? Where do we get those things that supply basic needs?
- II. Activity
 - A. Discuss with the students the term resource. Resources may be either materials or energy. Ask them to give examples. Define the term renewable resource. Explain that a renewable resource is a resource that can be replaced, replenished, or regrown.
 1. Give examples of renewable resources (sunlight, plants, animals) and ask the students to think of others.
 2. Explain that air and water can be thought of as renewable resources because, although there isn't any new air or water being made, they are constantly recycled in the environment.
 - B. Have the students speculate as to the meaning of the term nonrenewable resources. (Nonrenewable resources are those that cannot be replaced.) Fuels, such as oil (from once-living ocean life), gas (from decayed plants and animals), and coal (from once-living trees and other plants), were formed millions of years ago from the remains of living things. (This is why they are called fossil fuels.) Minerals and ores found in the earth are also nonrenewable.
 1. Show the students pictures of various resources and products that you have gathered from magazines. (See "EXAMPLES OF RESOURCES," included.) Ask them to describe the pictures in terms of the resources represented and whether the resources are renewable or nonrenewable.
 2. Remind the students that we use energy in almost every phase of producing and using resources. For example, energy from fuels is used by all the vehicles and equipment involved in growing and harvesting crops, manufacturing products, transporting raw materials to factories and products to markets, and even by us (the consumers) when we use the products.
 3. Depending upon your students' levels of knowledge, you may discuss recycling with them. Note for them the definition of recycling. Make sure they understand that many materials are recyclable but that energy is not. When we use energy, it changes so that we cannot re-use the same energy again. Recycling materials helps conserve materials (many of which are nonrenewable), but also helps conserve energy because less energy is used in recycling than in obtaining new materials from their sources.

- C. Introduce the term conservation. Explain that conservation does not mean not using a resource, but rather using a resource wisely and efficiently. Help the students understand that without conservation, many things they take for granted will cease to be available (either because the resources are used up or have become so rare that they are too expensive for most people to use).
1. Divide the students into groups of about three or four members each. Show them some reference materials on conservation. Give each group an energy-using device to research (e.g., automobiles, heating and cooling systems, kitchen appliances, lighting devices, laundry equipment, and sources of entertainment).
 2. Tell the groups that are researching devices used in their homes to look at their home electric meters. Have them observe the difference in the speed of the meters' hands as energy use increases or decreases.
 3. Ask the members of each group to develop a poster depicting how to conserve energy using the devices they researched. Ask each group to display its poster and explain the message of the poster.

For example, the group researching lighting could make a "light bulb reminder" to place by the classroom light switches to remind people to conserve energy by turning off unused lights. (See the illustration.)

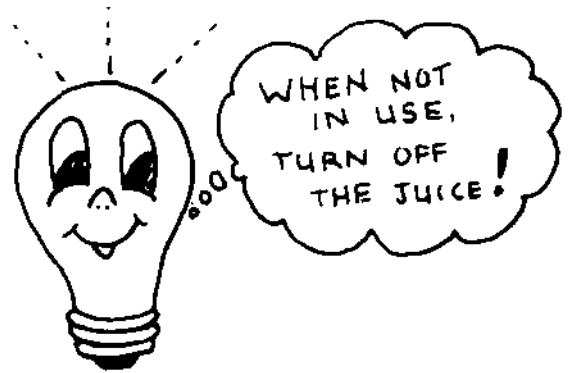

III. Follow-up

Use the following questions for discussion:

- A. How are nonrenewable resources different from renewable resources? (Nonrenewable resources are those that cannot be replaced once they are used; renewable resources are those that can be replaced.)
- B. Identify whether these things are renewable resources (R) or nonrenewable resources (N): metals (N), trees (R), air (R), coal (N), ores (N), animals (R), stone—such as granite, marble, gravel—(N), oil (N), plants (R), and sunlight (R).
- C. Have the students think of ways to share the posters. (They could be posted in hallways, public libraries, businesses, city/county government facilities, or other places.)

IV. Extension

- A. Ask the members of each group to develop a plan for conserving energy when using the devices they researched. They will be compiling their plans in a conservation handbook. Ask each group to present its plan to the class. After the reports have been presented, compile all of the reports into a handbook, and have the students give the handbook a title. Ask the students how they could let others know about the conservation booklet they have made. (The students may suggest local newspapers, spots on radio and TV stations, newsletters, notices posted at community recycling facilities, and other media.)

- B. Have the students use the energy conservation plans at home. Tell them to try to use as many ideas as possible. Later, have them share with the rest of the class what they did at home to conserve energy. Keep a list of all the ideas as they are used. If a student's family insulated a house or put up storm windows, add that to the list also.







- C. Have the students find out more about recycling. As it becomes more difficult for communities to handle the amounts of waste their citizens generate, more and more communities are starting recycling programs. What materials are being recycled in your city or town? Your class may want to start a recycling project of its own.

RESOURCES

Mallinson, G. G., J. B. Mallinson, D. G. Brown, W. L. Smallwood, and J. Knapp. Science: Understanding Your Environment. Lexington, ME: Silver Burdett and Ginn, 1981.

Sullivan, H., K. Ice, T. Boscon, and J. Larson. Power Switch. Lakewood, CA: The Energy Source Education Council, 1984.

EXAMPLES OF RESOURCES

| EXAMPLE | RESOURCE, PRODUCT, PACKAGING | MADE FROM (RESOURCE) | RENEW. OR NONRENEW. | CAN BE RECYCLED* |
|---|--|--|---------------------------|------------------------|
|  | Motor oil Plastic bottle | Petroleum Petroleum | N N | Yes Yes |
|  | Cereal Paper box Plastic liner | Plants Trees Petroleum | R R N | No Yes No |
|  | Firewood | Trees | R | No |
|  | Gasoline | Petroleum | N | No |
|  | Honey Glass jar Metal lid Paper label | Plants, animals Minerals Minerals Trees | R N N R | No Yes Yes No |
|  | Light energy | Sun | R | No |

* Some materials (like used oil and some plastics) are recyclable, although they are not usually recycled. Glass, aluminum, and some paper (chiefly newspaper and high-grade plain white paper) are the most easily recycled materials.

GLOSSARY

chemical energy: energy stored in matter (simply because of its composition) and released when compounds are changed; e.g., the energy stored in fuel.

conduction: the transfer of heat energy within substances or objects as their molecules collide with increasing energy, spreading heat energy throughout them.

conductor: a substance or body capable of transmitting heat (also used for a substance or object capable of transmitting sound, or electricity).

conserve: to use (a resource) wisely and efficiently.

convection: the transfer of heat energy due to the movement of currents of heated gas or liquid; for example, warm air rises and cool air sinks, creating an air flow pattern.

degrees: units of measurement of temperature.

detect: to discover or perceive.

device: a thing used for a specific purpose.

electrical energy: energy produced by electrons moving through wires.

energy: the ability to do work.

fossil fuels: fuels from ancient, once-living plants and animals; coal, petroleum, or natural gas.

insulator: a material that resists the flow (is a poor conductor) of heat energy and is used to prevent undesired heat flow.

kilowatt: a unit of electrical power equal to one thousand watts.

kilowatthour: a unit that measures the amount of electrical work done; the unit by which electricity is sold.

kinetic energy: the energy of motion (or heat or light).

matter: anything that has mass and takes up space; everything is either matter or energy.

mechanical energy: the energy possessed by the moving parts of machines.

nonrenewable: not able to be restored or replenished.

nuclear energy: the energy that results when the nuclei of uranium atoms are split.

potential energy: stored energy; energy that will not do any work until released or changed.

radiation: the transfer of heat energy by invisible waves (in the infrared range); not the same as nuclear radiation (high-energy particles and/or waves given off when the nuclei of atoms change).

recycle: to use a material again in a form similar to its original form; for example, newspapers can be recycled into cardboard, more newspapers, or other products.

refraction: the bending of a wave (such as light) as it passes from one medium into another (e.g., passing from air into water).

renewable: able to be restored or replenished.

resource: a supply of a valuable or useful thing; something that can be used to make or supply something else.

shaft power: energy transferred to the moving parts of a device by a shaft; for example, appliances have drive shafts that put their mechanical parts in motion by supplying energy to them from their electric motors.

solar energy: a type of kinetic energy (more precisely called radiant energy), much of which is observable as visible light.

temperature: the hotness or coldness of something; a factor in determining the heat energy possessed by something.

thermometer: instrument used to measure temperature in degrees.

watt: a measure of electric power; the product of amperes (flow) and number of volts (push).

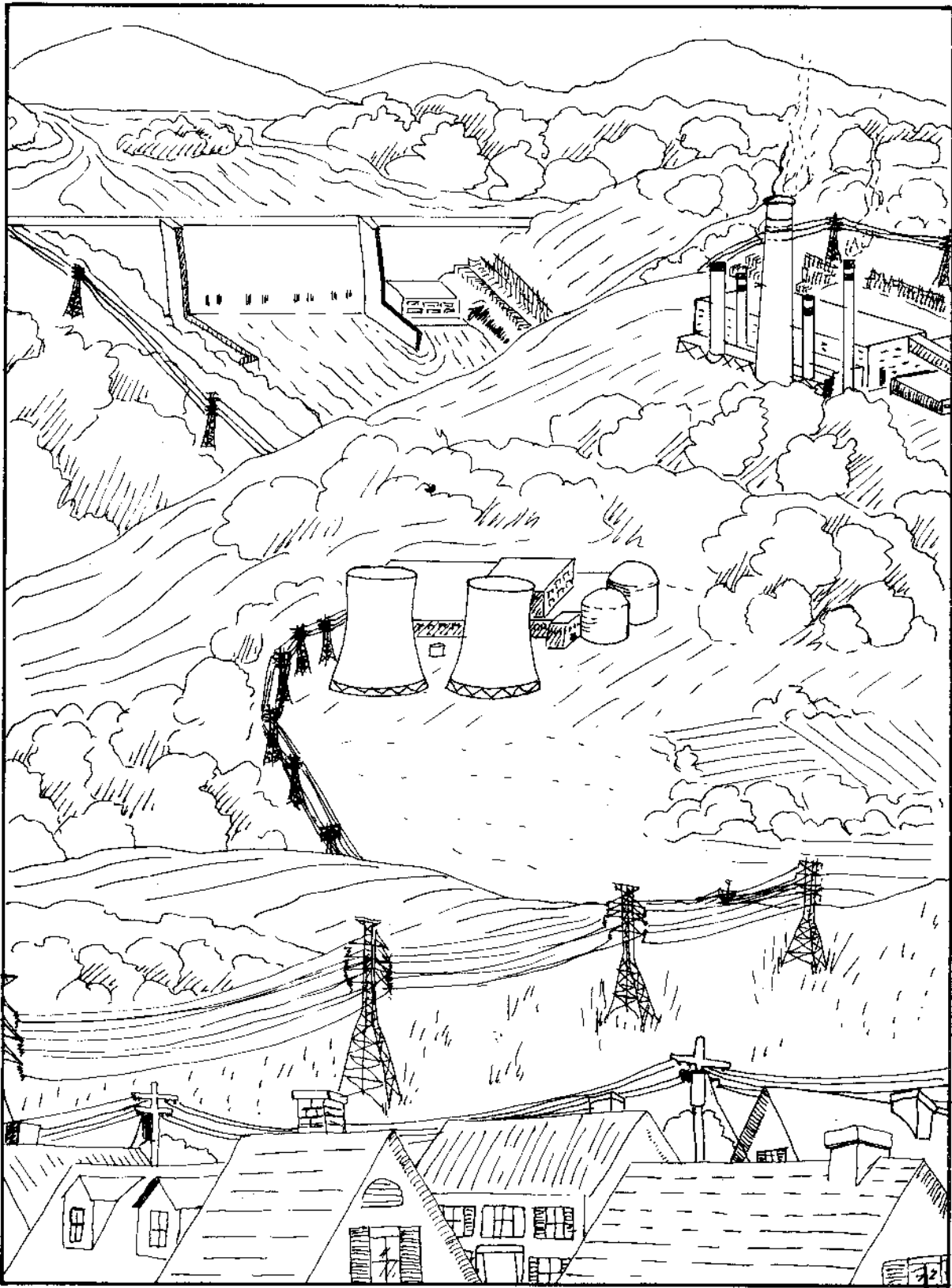

LINKS IN A CHAIN

OBJECTIVES

The student will do the following:

1. Describe the eight forms of energy (light, heat, sound, electrical, mechanical, magnetic, chemical, and nuclear).
2. Observe and describe energy transformations.

SUBJECTS:

Science

TIME:

120 minutes

MATERIALS:

red construction paper, scissors, transparent tape, posterboard, markers, student sheets (included)

BACKGROUND INFORMATION

There are many forms of energy. Light, heat, sound, and electrical energy are familiar to us in our everyday lives. Other forms, which may not be as familiar, are mechanical, magnetic, chemical, and nuclear energy.

Energy cannot be created or destroyed, but it can be changed from one form to another. Burning coal as fuel changes its chemical energy to heat energy. We can use the heat energy directly (for example, to warm us or heat materials like metals in industrial processes), or we can use the heat energy to produce some other kind of energy. Heat energy can be used to boil water. The steam can spin a turbine, producing mechanical energy. Turbines run generators to produce electricity. We then use the electricity to produce light, heat, sound energy, or power for mechanical energy. Our everyday lives are filled with examples of chains of energy transformations.

Terms

chemical energy: energy stored in matter because of its composition; energy that is released when compounds change; e.g., the energy stored in fuel.

electrical energy: energy produced by electrons pushing through wires.

energy: the ability to do work.

energy chain: a series of energy transformations from one form to another.

heat energy: the internal energy of a substance or object due to the movement of its particles.

kinetic energy: the energy of motion.

light energy: a form of energy that travels in waves and can be detected by the unaided human eye.

magnetic energy: the energy of attraction for iron and similar materials; such materials may have this energy naturally or it may be induced in them (as with an electromagnet).

mechanical energy: energy possessed by the moving parts of machines.

nuclear energy: the energy released when the nuclei of uranium atoms are split.

potential energy: stored energy, or the energy of position.

sound energy: the form of energy which travels in waves and causes the vibration of particles of air, water, or solids; detected by the ears.

PROCEDURE

I. Setting the stage

A. Tell the students that energy from the sun runs their television sets. Show evidence for this statement with the following presentation:

1. Prepare before class a blank bulletin board and the following construction paper cut-outs.

a. A circle labelled "sun."

b. A square labelled "TV."

c. Eight links (cut by the pattern on the student sheet "LINK PATTERN," included), labelled as follows:

(1) Potential energy, water (see illustration)

(2) Heat energy, water vapor

(3) Kinetic energy, rain

(4) Potential energy, reservoir

(5) Mechanical energy, turbine

(6) Electrical energy, generator

(7) Electrical energy, television

(8) Light energy, picture

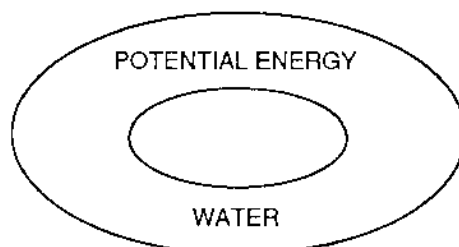

2. Place the sun piece at one end of the board and the TV piece at the other. Give the eight links to eight students and tell them to post the links on the board as you talk through the chain of energy transformations.

3. Share with the students the following narrative:

Energy from the sun runs your television set. The energy is changed and transferred many times between the sun and the television screen. The sun's energy is stored on earth in three forms of matter—water, food, and fuel. The sun's energy heats water (for example, in oceans, lakes, and other bodies), evaporating it. The water rises into the atmosphere as water vapor. High in the atmosphere, the vapor cools, condensing and forming clouds from which fall rain, sleet, or snow. The rain falls to earth and some of it flows into rivers or lakes. Where rivers are dammed, the water is stored temporarily behind the dams. When the water is released through a hydroelectric dam, the force of the water can turn a turbine. As the turbine spins,

it spins the generator to which it is connected. The spinning of the generator produces an electrical current which is then sent along wires to your house. The current travels through the cord of your television set which uses it to produce the light that you see as the picture.

- B. Give each student a copy of student sheet "ENERGY TERMS" (included), and briefly discuss each definition.

II. Activity

- A. Have the students demonstrate that energy changes matter.

1. Give each student a sheet of red construction paper. (Red works best, but any dark construction paper will do.) Have each student tape a pair of scissors or any interestingly shaped item to the construction paper.
2. Have them place their sheets of paper in a sunny window and wait for five days before removing the scissors or other objects from the paper.
3. Discuss with them what has happened to the paper. (Light energy changed the red chemicals in the paper.) Make sure they understand that energy causes changes in matter.

- B. Have the students research the eight forms of energy.

1. Divide the class into eight groups.
2. Assign each group one of these forms of energy to research—light, heat, sound, electrical, mechanical, magnetic, chemical, or nuclear. Provide encyclopedias, textbooks, and other reference materials (or arrange to bring the class to the library).
3. Each group is to design a poster that shows the basic information about the energy form assigned to it. The poster should include the source(s) of that energy, the form it takes, its uses, and so on.

- C. Have the students construct an energy transformation chain.

1. Divide the class into small groups of three or four students each.
2. Give each group four copies of the student sheet "LINK PATTERN," included. (This will provide eight links for each group's chain.)
3. Give the groups the following guidelines:
 - a. Choose a topic with which you are familiar. Some examples are energy chains from the sun to a hamburger that you eat, from the sun to electric heat in your home, or from the sun to heating your home with firewood.
 - b. Write down on paper each step in the process you have selected.
 - c. Cut out a link for each step. Label each link, using the terms potential energy, kinetic energy, light, heat, sound, electrical energy, mechanical energy, magnetic energy, chemical energy, and nuclear energy.
 - d. Tape the chain together.
 - e. Post the chain as you are directed.

III. Follow-up

- A. Give each student a copy of the student sheet "FORMS OF ENERGY," included. Have the students find and circle the listed energy terms in the word search puzzle. The answers are as follows:

```
. . . . . L . . . . .
. . . . . A . . . . .
. . . . . C . . . . .
. N . . I . . . . .
. . U M A G N E T I C . .
. . E C E N E R G Y . . .
. H . . L C . . S . . . .
C . . . E E H . O . . . T
. . . . C . A A U . . H .
. . . . T H . R N . G . .
. . . . R E A . D I . . .
. . . . I A . I L . C . .
. . . . C T . . N . . A .
. . . . A . . . . . . L
. . . . L . . . . . . .
```

- B. Give each student a copy of the student sheet "ENERGY CROSSWORD," included. Have the students complete the puzzle. The answers are as follows: ACROSS—1. mechanical, 3. magnetic, 4. sound, 6. chemical, 7. heat, 8. light; DOWN—2. electrical, 5. nuclear.
- C. Have each group give a three-minute presentation about its poster, summarizing the information about the form of energy it was assigned.

RESOURCE

Sund, R. B., D. K. Adams, J. K. Hackett, and R. H. Mayes. Accent on Science. Columbus, OH: Merrill, 1985.

LINK PATTERN

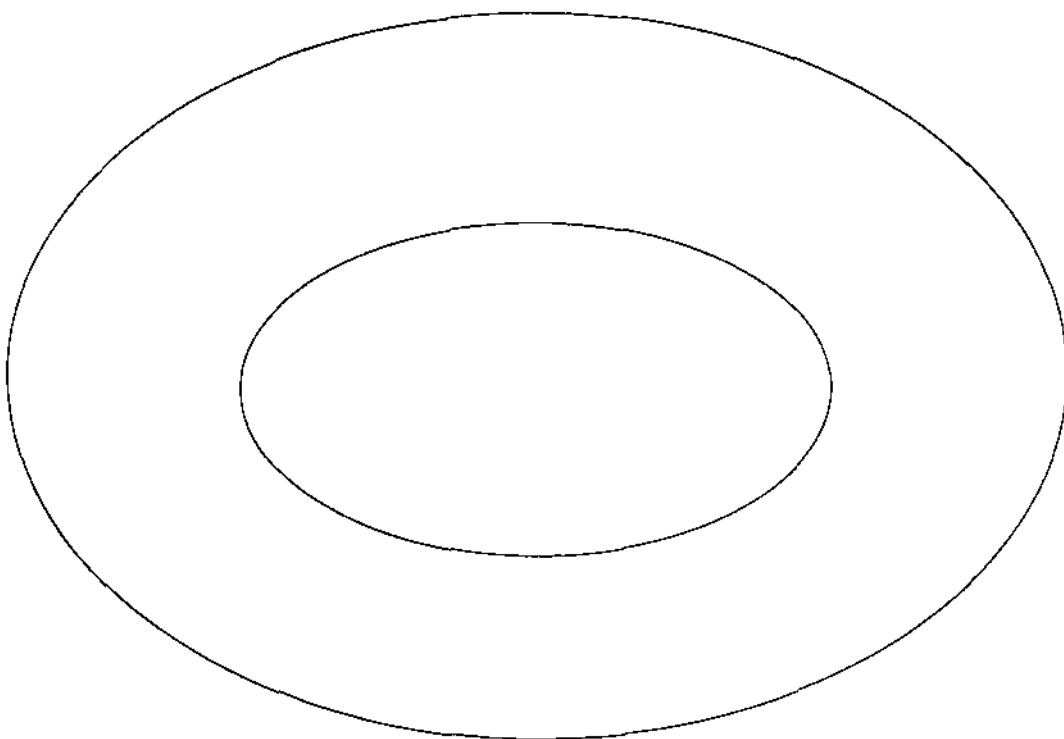
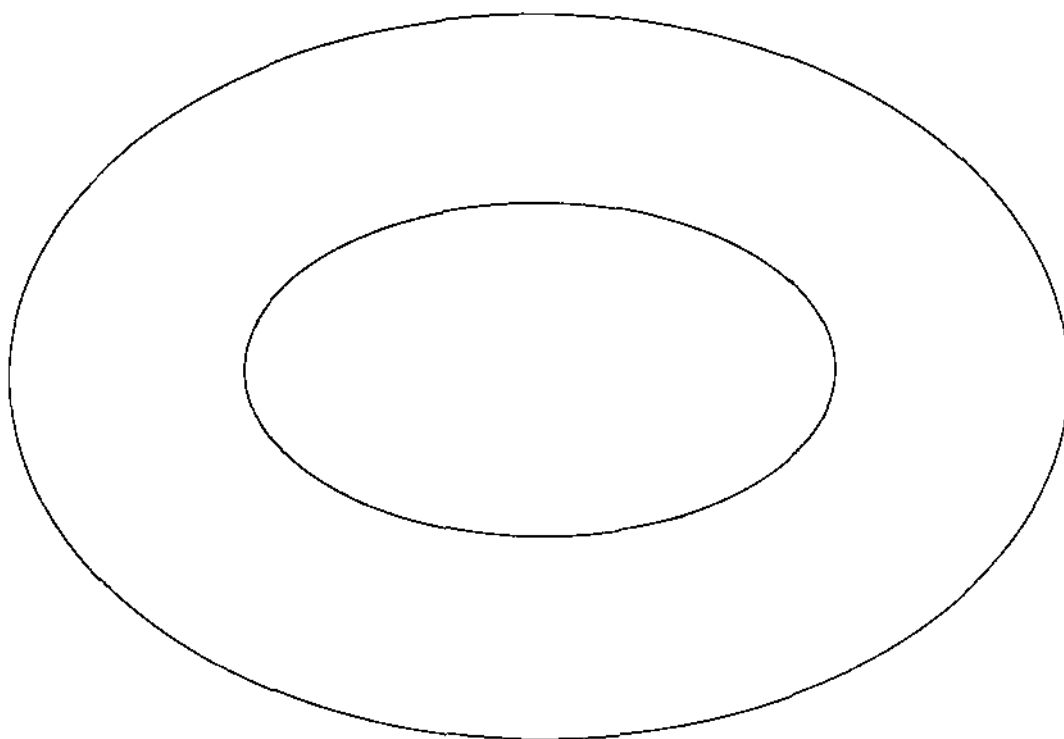

ENERGY TERMS

chemical energy: energy stored in matter because of how it is made up; energy released when matter changes; examples of chemical energy include the energy stored in fuels and the energy stored in batteries.

electrical energy: energy produced by electrons pushing through wires.

energy: the ability to do work.

energy chain: a series of energy transformations from one form to another.

heat energy: the energy in matter because of the movement of the particles which make it up.

kinetic energy: the energy of motion.

light energy: a form of energy that travels in waves and can be detected by the eyes.

magnetic energy: the energy of attraction for iron and similar materials; such materials may have this energy naturally or may gain it, as an electromagnet does.

mechanical energy: the energy of the moving parts of machines.

nuclear energy: the energy released when the nuclei of uranium atoms are split.

potential energy: stored energy, or the energy of position.

sound energy: the form of energy which travels in waves and causes the vibration of particles of air, water, or solids; detected by the ears.

FORMS OF ENERGY

Can you find these words?

MECHANICAL
CHEMICAL
CHAIN
HEAT

ELECTRICAL
NUCLEAR
SOUND

MAGNETIC
ENERGY
LIGHT

They may be spelled backwards, or they may go from corner-to-corner. When you find them, circle them and check them off the list.

| | | | | | | | | | | | | |
|---|---|---|---|---|---|---|---|---|---|---|---|---|
| I | L | X | O | Z | U | H | L | E | U | W | L | Z |
| T | D | I | X | G | N | A | S | F | U | L | F | M |
| Y | P | S | I | R | C | G | W | P | F | V | E | H |
| U | N | Q | A | I | D | W | I | N | S | E | N | Z |
| E | S | U | M | A | G | N | E | T | I | C | S | G |
| U | B | E | C | E | N | E | R | G | Y | X | B | G |
| T | H | A | F | L | C | W | Z | S | H | U | C | M |
| C | O | E | P | E | E | H | H | O | G | O | P | T |
| R | M | G | V | C | K | A | A | U | E | N | H | E |
| V | T | D | U | T | H | H | R | N | Y | G | X | Y |
| W | F | F | E | R | E | A | W | D | I | C | U | I |
| R | B | J | S | I | A | R | I | L | A | C | P | T |
| U | E | C | S | C | T | W | G | N | P | P | A | P |
| A | U | L | T | A | Z | J | J | O | M | B | D | L |
| I | D | K | U | L | U | Y | J | N | I | K | M | Y |

ENERGY CROSSWORD

ACROSS:

1. The energy possessed by the moving parts of machines.
3. The energy of attraction which iron may have naturally.
4. Energy form consisting of waves of vibration carried in the air, water, or solids.
6. The energy stored in matter; released by chemical change.
7. The energy of the movement of the particles making up a substance.
8. A form of energy that travels in waves and is detected by the eyes.

DOWN:

2. The energy of electrons pushing through wires.
5. The energy released when the nuclei of uranium atoms are split.

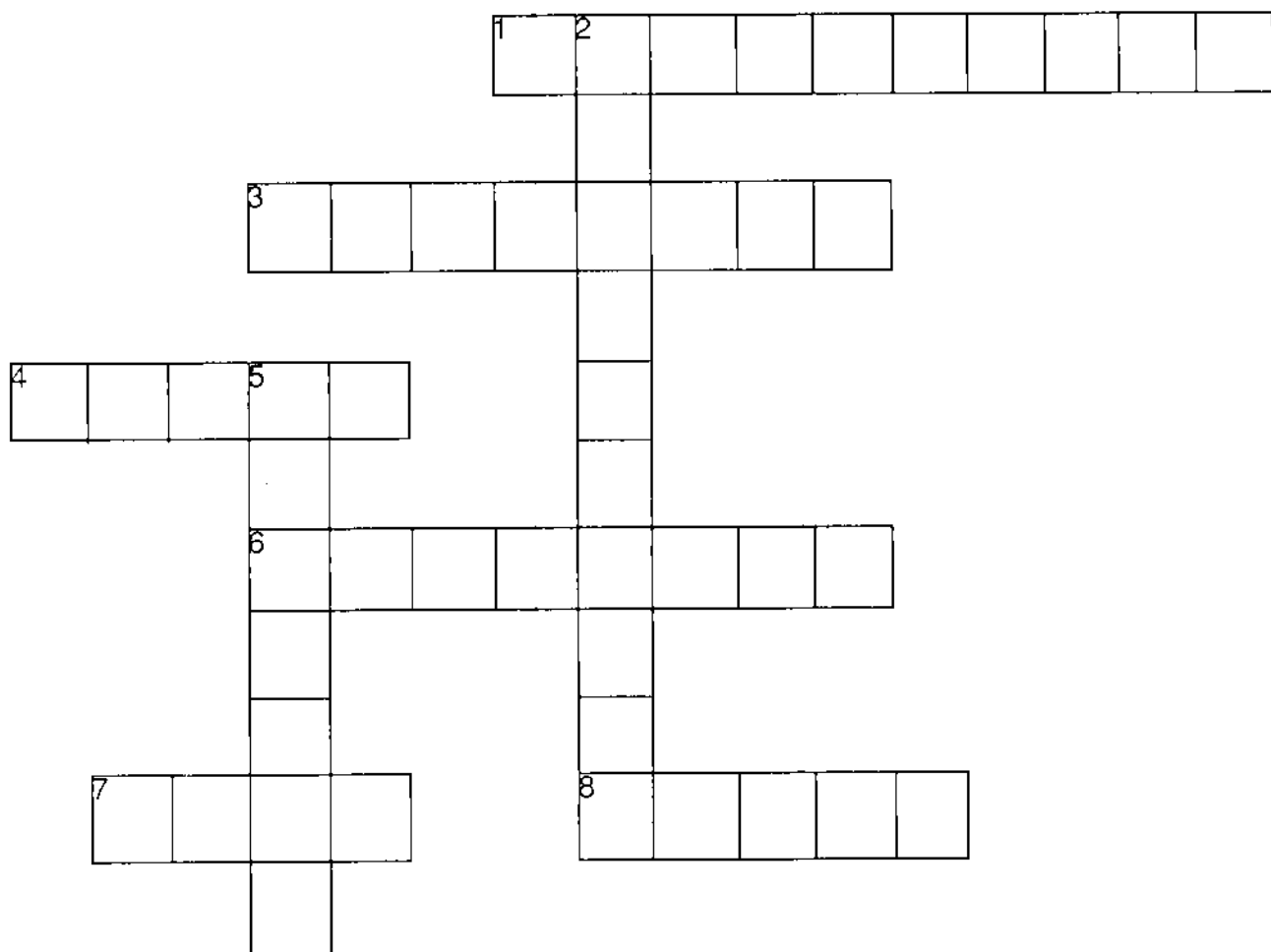

SAFETY FIRST

OBJECTIVES

The student will do the following:

1. Recall safety rules for using electricity.
2. Look for places in the home or at school that are examples of unsafe electricity use.

SUBJECTS:

Science, Art

TIME:

120 minutes

MATERIALS:

scissors, posterboard or newsprint, string, markers, shoe boxes, assorted craft materials

BACKGROUND INFORMATION

Electricity is a very versatile and convenient source of energy, but it must be used with great care. Faulty wiring or overloaded sockets can cause fires. An electrical current—even one of low voltage—can kill you if you touch a bare wire with wet hands or while standing on a wet floor.

Purchase only electrical tools and appliances that have the seal of approval from Underwriters Laboratories (UL). This nonprofit organization tests electrical products and approves only those that meet its safety standards. Furthermore, all electrical products should be used carefully. Always follow the manufacturer's instructions. Never operate a power tool in the rain or in a damp area. Pull the plug before cleaning or repairing an electrical tool or appliance, or before changing a power tool's accessories. Let a qualified repair service handle complicated repairs.

In homes where young children could be endangered by uncovered outlets, special caps should be installed to cover unused outlets. Never put anything except a plug into an outlet.

PROCEDURE

I. Setting the stage

A. Make the following statement to the students:

Electricity is our number one helper. It makes living and working easier, safer, and more fun. But this helper must be used properly to prevent accidents.

B. Divide the class into small groups. Give each group a large sheet of paper and some markers. Have each group make a list of rules for the safe use of electricity.

C. After about 20 minutes, have the groups share their lists with the class. Make a master list on the chalkboard.

II. Activity

- A. Make a poster of electricity safety rules before class. Include the following rules (you may wish to add others):
1. Never climb trees near power lines and never climb power poles.
 2. Never fly kites near power lines.
 3. Stay away from fallen power lines.
 4. Keep ladders and TV antennas away from power lines.
 5. Don't touch anything electrical when you are wet.
 6. Never pull a plug out of an outlet by the cord.
 7. Don't plug too many electrical devices into one outlet.
 8. Never use radios, hair dryers or other devices in bathtubs or showers.
 9. Keep fingers and other objects away from electrical outlets.
- B. Have the students prepare for an "Electrical Safety Parade."
1. Divide the students into groups of two or three. Assign each group a different safety rule.
 2. Have the students bring shoe boxes to class. Using the shoe boxes as bases, the groups are to design and build miniature parade floats for the safety rules they are assigned.
 3. Put the parade floats on display in the classroom, the library, or a display case in your school.
- C. Discuss with the students how electrical safety rules are abused. Make a list on the board.
1. Have the students make lists of places in the home and at school where they observe the safety rules being kept and where the rules are being broken.
 2. Have the students make tables or graphs showing the information they collected.

III. Follow-up

- A. Have the students in each group give a two- to three-minute presentation about the safety rule they were assigned.
- B. Have an electrical safety parade. As each group's float passes the "reviewing stand," have the group give a two-minute presentation about how its float illustrates its safety rule. Have the other students in the class rate the floats for originality, creativity, effectiveness, or other factors you determine to be important.
- C. Have the students list five unsafe electrical practices and how they could be corrected.

RESOURCES

About Electricity. Greenfield, MA: Channing L. Bete, 1979.

About Electricity Safety. Greenfield, MA: Channing L. Bete, 1979.

Electric Safety. South Deerfield, MA: Channing L. Bete, 1979.

TO ATTRACT OR NOT TO ATTRACT

OBJECTIVES

The student will do the following:

1. Describe and demonstrate some properties of magnetism.
2. Name some uses of a magnet.

SUBJECT:

Science

TIME:

90 minutes

MATERIALS:

bar magnets, pin, nail, paper, paper clips, chalk, wood, pennies, test tubes, shallow bowls, washers, tape, cardboard, 6-V or 9-V batteries with terminals, insulated wire, 6-in iron nails, student sheet (included)

BACKGROUND INFORMATION

Magnets are far more than mere toys. Though we do not often think about magnets, magnetism and its companion, electromagnetism, are the basis for much of our standard of living. Every electric motor, generator, and transformer is dependent upon a magnetic field. Even our telephones must have a magnetic field to work. Countless technologies that we use daily are possible because of magnetism.

Although the reason magnetism works is not yet altogether clear, its effects and laws are quite simple. Magnetic poles that are alike repel, and unlike poles attract. The strength of an electromagnet is determined by the strength of the electric current creating the electromagnetism and the number of wire coils around the core. The direction of the current's flow determines the polarity of an electromagnet. These three concepts are the basis of how most of the devices using magnets work.

Terms

attract: to pull closer.

compass: an instrument used for determining geographical directions by means of a pivoting magnetic needle (which always points north).

electromagnet: a soft iron core wound with a coil of wire; it becomes magnetic when an electric current passes through the wire.

magnetic field: the space around a magnet in which there is magnetic force.

magnetism: a magnet's force of attraction.

poles: the ends of a magnet; designated "north" and "south."

repel: to push away.

PROCEDURE

I. Setting the stage

- A. Lay these objects on a table in front of the students—a pin, a pen, a nail, some paper clips, a coin, a piece of chalk, a piece of wood, and a bar magnet.
- B. Draw a chart on the chalkboard like the one below. Make sure the students recall the meaning of the terms attract and repel.

MAGNET

| ATTRACTS | REPELS | HAS NO EFFECT |
|----------|--------|---------------|
| | | |

- C. Hold up each object (except for the magnet), and let the students decide in which chart category it should be placed. After the objects have been categorized, use the bar magnet to test the students' predictions.
- D. Ask the students what the objects attracted by the magnet have in common. (Metals containing iron are attracted by magnets, so objects made from such metals are attracted by magnetism.)

II. Activity

- A. Have the students investigate magnetic attraction. Divide them into pairs or small groups. Give each group a copy of the student sheet "THROUGH IT ALL?" (included), and have them complete the activity. They are to follow the directions on the student sheet. (Magnets will attract the paper clips even through paper, glass, and water. The students will enjoy trying to "walk" the clips. You may want to have team races.)
- B. Have the students compare the magnetic attraction of two kinds of objects. Give each group a copy of the student sheet "WHOSE SIDE ARE YOU ON?" (included) and have them continue to work in pairs or small groups to complete the activity. They are to follow the directions on the student sheet. (The penny will slide down one side of the line and the washer, the other. The washer is made of steel [which is made from iron] and is attracted by the magnet. The penny is made of zinc and copper and is not attracted by the magnet. Many people try to use slugs and washers in snack or soda vending machines. Magnets are used in the machine to pull them out. Magnets are also used in aluminum recycling operations. Cans made of steel, rather than aluminum, will be pulled out by magnets. The aluminum is not attracted by the magnets.)
- C. Have the students demonstrate electromagnetism.
 1. Place some paper clips on your desk. Ask some students to pick up the paper clips by simply holding a nail above them. This, of course, will not work. Tell them that in a few minutes it will work.

2. Divide the students into pairs or small groups. Give each group the student sheet "THE MAGIC NAIL" (included) and the materials needed for the activity. Have the groups follow the directions on the student sheet. (When the wire has been disconnected from one terminal, most of the paper clips will drop. Some may remain, because the nail has become magnetized. The students can determine the north and south poles of the nail by using a bar magnet and testing for attraction or repulsion.)

III. Follow-up

- A. Have the students complete these lists:
 1. List five things that magnets will attract.
 2. List five things that magnets will not affect.
- B. Give the students the student sheet "TO ATTRACT OR NOT TO ATTRACT," included. Have them answer the questions independently. (The answers are as follows: 1. iron, steel; 2. attract; 3. force; 4. poles; 5. repel; 6. attract; 7. north.)
- C. Have the students conduct a "Magnet Search." Using reference materials, interviews, and other resources, the students will make lists of the ways magnets or electromagnets are used. Offer prizes to the students with the best lists.

RESOURCES

Feravolo, R. V. Electricity. Champaign, IL: Garrard, 1960.

Freeman, I. M. All About Electricity. New York: Random House, 1957.

Freeman, I. and M. Freeman. The Story of Electricity. New York: Random House, 1961.

Neal, C. D. Safe and Simple Projects with Electricity. Chicago, IL: Children's Press, 1965.

Reuben, G. Electricity Experiments for Children. New York: Dover, 1960.

THROUGH IT ALL?

MATERIALS: magnet, paper clips, paper, test tube, shallow bowl, water

1. Put some paper clips on your desk.
2. Lay the paper on top of the paper clips.
3. Put the magnet on the paper.
4. Lift the paper and the magnet together.
5. What do the paper clips do?
6. Now put the paper clips on top of the paper.
7. Put the magnet under the paper and try to “walk” the paper clips across it. Can you do it?
8. Put a paper clip in the test tube.
9. Use the magnet to try to move the paper clip inside the test tube.
10. Can you move the paper clip with the magnet?
11. Put some water into a shallow bowl.
12. Put some paper clips in the water.
13. Put the magnet in the water.
14. Can you pick up the paper clips?

In this activity, you learned that magnets can attract paper clips through _____,
_____, and _____.

WHOSE SIDE ARE YOU ON?

MATERIALS: magnet, penny, washer, tape, cardboard (half sheet), chalk

1. Draw a line down the center of the cardboard on both sides.
 2. Tape the magnet to the cardboard about one inch from the line.
 3. Turn the cardboard over.
 4. Lean it on a stack of books.
 5. Rub chalk on one side of both the washer and the penny.
 6. Place the washer on the cardboard (chalked side down). Slide it down the line on the chalkboard. Try this several times. Repeat this, using the penny.
 7. What did the washer do? _____
 8. What did the penny do? _____
 9. What can you conclude the washer must be made of? _____
- Why? _____

THE MAGIC NAIL

MATERIALS: 6-volt or 9-volt battery with terminals, insulated wire, 6-inch long iron nail, paper clips, bar magnet

1. Wind the insulated wire around the nail about 20 times. Leave enough wire unwound to let both ends hang free.
2. Take some insulation off the ends of the wire. Connect the ends of the wire to the battery terminals.
3. Try to pick up the paper clips with the nail. What happens? _____
4. Undo the wire from one battery terminal. What happens to the paper clips?

5. Can you find the north pole and south pole of the nail? _____
How did you do it? _____

TO ATTRACT OR NOT TO ATTRACT

Unscramble the words and fill in the blanks.

1. Magnets will stick to metal objects if they have _____ or _____ in them.
n r o i e e l s t
2. When a magnet pulls something, it is said to _____ it.
a a c r t t t
3. Magnets can pull things because of a _____.
c e f o r
4. The ends of a magnet are called _____.
e l o p s
5. A north pole and a north pole will _____ each other.
e e l p r
6. A north pole and a south pole will _____ each other.
t c a r a t t
7. The needle on a compass always points _____.
h n o r t

MR. CONDUCTOR—PLEASE!

OBJECTIVES

The student will do the following:

1. Define electrical conductor and electrical insulator.
2. Identify and use electrical conductors and insulators.

SUBJECT:

Science

TIME:

120 minutes

MATERIALS:

candle, matches, nail, pliers, wire, posterboard or construction paper, teacher sheets (included), thumbtacks, masking tape, batteries, flashlight bulbs, nails and other items to test, old magazines, scissors, glue, student sheets (included)

BACKGROUND INFORMATION

Most metals are conductors of electrical current. Metals such as copper, aluminum, and silver are very effective conductors. These metals have an atomic structure in which electrons have more freedom to change places and move. This allows electrons to flow more freely through these metals.

Insulators such as wood, rubber, and glass do not allow electricity to flow through them. Their atomic and molecular structures restrict the movement of electrons. Their electrons are not free to move from place to place; thus, they make good insulators.

Terms

conductor: material through which electricity can flow.

insulator: material through which electricity cannot flow easily.

PROCEDURE

- I. Setting the stage
 - A. Do the following demonstration to encourage the students to think about conduction.
 1. Prepare for the demonstration prior to class.
 - a. Light a candle. Holding a large nail with a pair of pliers, drip candle wax onto the nail. Make several large clumps of wax along the shaft.
 - b. Embed a thumbtack in each clump of wax.
 2. Light a candle. Hold one end of the nail with a pair of pliers, and put the other end of the nail into the candle flame. **CAUTION—NAIL GETS HOT.**

3. Have the students observe what happens to the wax and thumbtacks. Which drop of wax melted first? Which wax melted last?
- B. Discuss with the students the movement of heat through the nail. Make sure they know that this is heat conduction. Compare this movement of heat to the movement of electricity through a conductor.
- C. Ask the students what will stop electricity (if a conductor allows electricity to pass through). Accept examples of insulators. If no one uses the term "insulator," supply the students with that word.

II. Activity

- A. To help the students distinguish between conductors and insulators, prepare the puzzles "CONDUCTOR CRITTER PUZZLE" and "INSULATOR ANIMAL PUZZLE" (teacher sheet masters).
 1. You may prepare one and use it as a large group activity; or, if time permits, you may wish to prepare several sets for use with small groups. If you are making one large set, you may want to use an opaque projector and cut the pieces from posterboard. If you are making several small sets you might wish to use construction paper and draw the puzzle by hand.
 2. Put the pieces of both puzzles together in a folder. (If making small sets, use one folder for each set.) Place the following directions on the folder(s):
 - a. Take the puzzle pieces out of the folder.
 - b. You will find a material listed on each puzzle piece. Each material is either an electrical conductor or insulator. You are to separate the puzzle pieces into conductors and insulators.
 - c. Once you have grouped the puzzle pieces into two piles, try to form an animal out of each group. If you have correctly grouped the puzzle pieces, they will form an animal.
- B. Have the students do the conduction experiment on the student sheet "YOU LIGHT UP MY LIFE," included. Provide the materials required for the activity and supervise the students carefully.
- C. Have the students identify some of the many conductors and insulators used in different areas.
 1. Divide the class into three groups. Assign each group one of these areas—home, industry, or school.
 2. Provide each group with one half sheet of posterboard. Draw a line down the center of the posterboard. Label one side "conductor." Label the other side "insulator."
 3. Have the students cut from magazines or draw examples of conductors and insulators used in their group's assigned areas.

III. Follow-up

- A. Have the students complete the student sheet "MR. CONDUCTOR—PLEASE!" (included), identifying conductors and insulators. (The conductors are water, silver, aluminum, copper, gold, and tin. The insulators are wood, wool, plastic, foam rubber, and air.)

- B. Have the students define conductors and insulators. What do they notice about most of the conductors? How are they different from the insulators?
- C. Have the groups share their posters of insulators and conductors in the home, industry, and school with the class.

RESOURCES

Freeman, I. and M. Freeman. The Story of Electricity. New York: Random House, 1961.

Sund, R. B., D. K. Adams, J. K. Hackett, and R. H. Mayes. Accent on Science. Columbus, OH: Merrill, 1985.

CONDUCTOR CRITTER PUZZLE

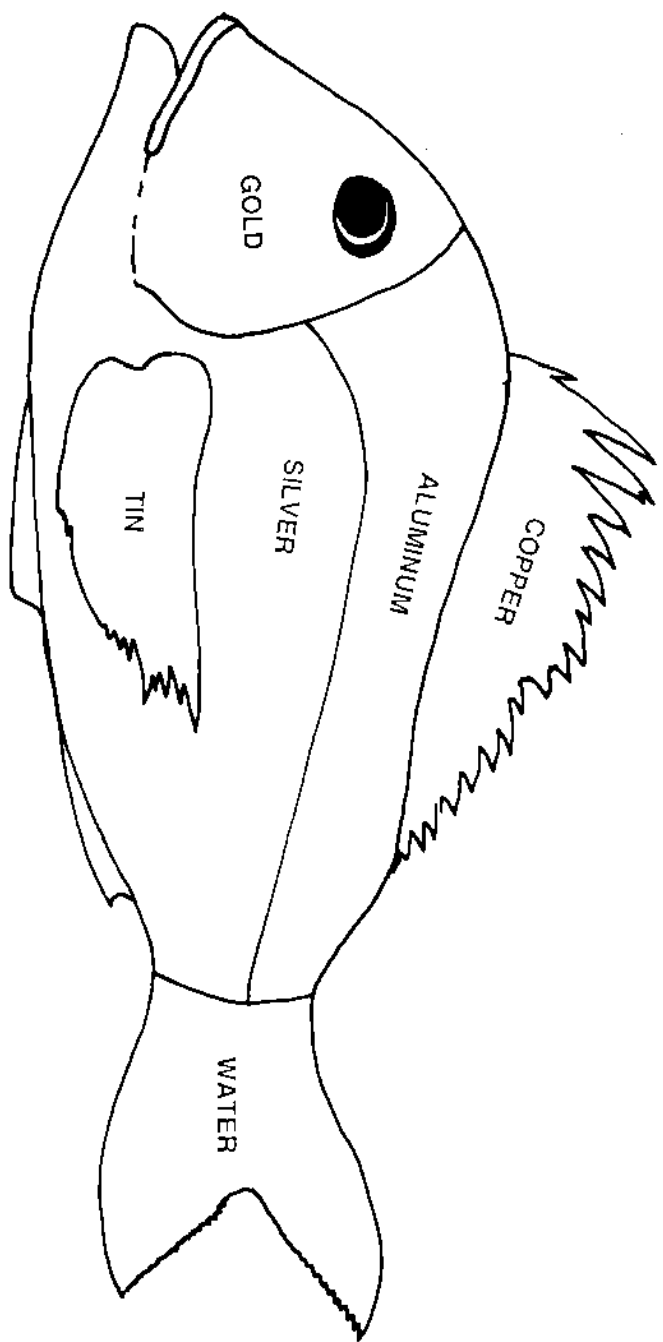

INSULATOR ANIMAL PUZZLE

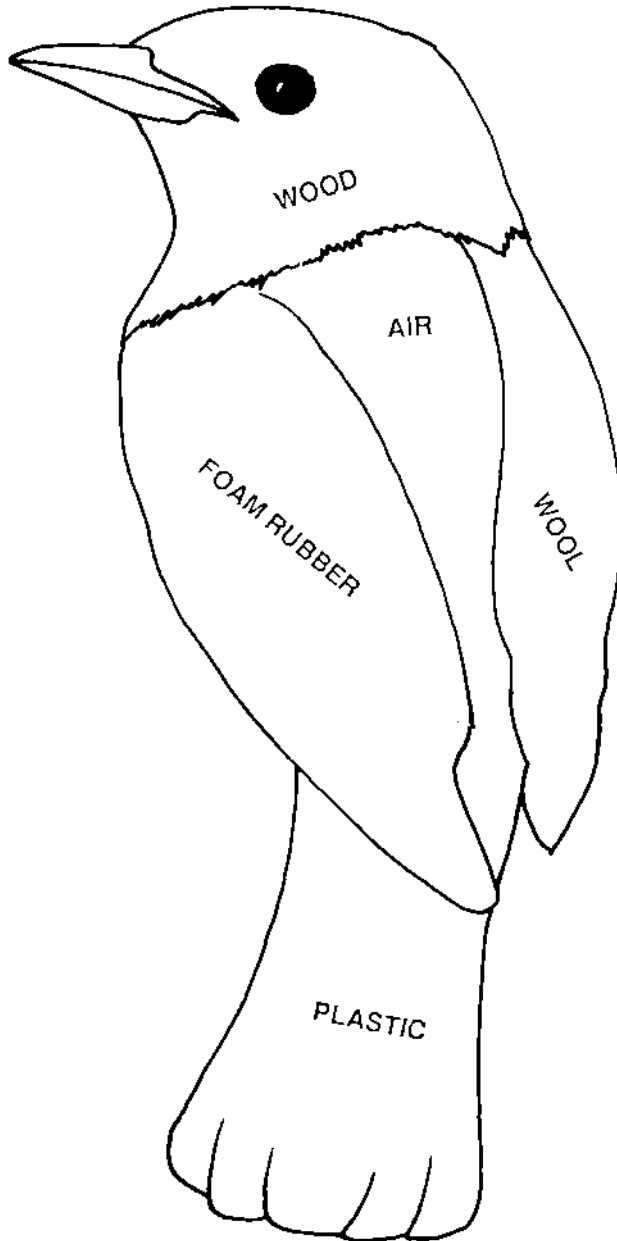

YOU LIGHT UP MY LIFE

Materials: two batteries, masking tape, flashlight bulb, wire, nail and other objects

1. Make a simple electrical conductivity tester.
 - a. Tape the batteries together. The bottom end of one should touch the top end of the other.
 - b. Scrape about 2 inches of covering off each end of the piece of wire. Twist one of the bare ends around the metal part of the flashlight bulb. Tape the other end tightly to the bottom of the battery.
 - c. Now touch the bottom tip of the bulb to the top post of the battery. The bulb should light up if all the connections are clean and tight.
2. Use the tester to find out if materials are conductors or insulators.
 - a. Hold a clean nail between the top post of the battery and the tip of the flashlight bulb. The bulb will light up just as before. This shows that the iron nail is a conductor of electricity.
 - b. Try other things, too. Here are some things that you can test—an eraser, a key, paper, glass, aluminum foil, a penny, a candle, a match stick, a paper clip, a pencil lead, cellophane, cork, a comb, a crayon.
3. Make a list of conductors and a list of insulators.

| Conductors | Insulators |
|------------|------------|
| | |
| | |
| | |
| | |
| | |
| | |
| | |
| | |
| | |

MR. CONDUCTOR—PLEASE!

Circle all the materials that are conductors. Put a ~~line~~ through all the materials that are insulators.

WATER

WOOD

SILVER

WOOL

ALUMINUM

PLASTIC

COPPER

GOLD

FOAM RUBBER

AIR

TIN

GOING AROUND IN CIRCUITS

OBJECTIVES

The student will do the following:

1. Define an electrical circuit.
2. Construct an electrical circuit.
3. Distinguish between parallel and series circuits.

SUBJECT:

Science

TIME:

120 minutes

MATERIALS:

flashlight bulbs, C or D batteries, noninsulated wire, masking tape, teacher and student sheets (included)

BACKGROUND INFORMATION

Current electricity is the movement of charged particles—electrons—along a conductor, such as a wire. Current electricity is generated from a source such as a battery or generator. Current electricity flows along a closed path called a circuit.

Electric circuits behave differently depending on how they are connected. A parallel circuit is a circuit that consists of more than one path through which electricity can flow. If one bulb burns out, the remaining bulbs are not affected. A series circuit is a circuit that consists of only one path. If one bulb burns out, all the bulbs in the circuit will go out.

Terms

current electricity: the flow of electricity; the movement of electrons through a circuit.

circuit: a path for the flow of electrical current; composed of elements such as a source of electricity, something that uses electricity, and the wires connecting them.

parallel circuit: a circuit in which the elements that use electricity are arranged so the same voltage is applied at each one; that is, a circuit that consists of more than one path through which electricity can flow.

series circuit: a circuit in which all the elements that use electricity are connected one after the other so that the current's voltage is divided among them; that is, a circuit that consists of only one path through which electricity can flow.

PROCEDURE

I. Setting the stage

- A. Prepare by duplicating and cutting out the electrons on teacher sheet "ELECTRONS," included. (You need one electron for each student.)

- B. Play the electron game. Have the students form a circle around the classroom. Tell the students the following rules:
1. Each student may hold only one electron at a time.
 2. As students receive successive electrons, they must pass their electrons to the right.
- C. Start passing out electrons and keep handing them out until each student has one. The electrons will be moving around the circle. Let the students do this for a few rounds to show that current electricity is flowing.
- D. When the students have seen the electrons in motion, remove one electron. Tell the students that when the current is interrupted, the circuit is broken and electricity ceases to flow.

II. Activity

- A. Divide the class into small groups. Give each group a flashlight bulb, a C or D battery, two pieces of noninsulated wire, and some masking tape. Tell the groups to light the bulbs. The masking tape is to be used to hold the wire in place, connecting the bulb and the battery. The groups are to draw pictures showing the circuit.
- B. Duplicate for each student a copy of the student sheet "WHICH ONES WORK?," included. (In a simple circuit, one wire goes from the power source—the battery—to where the power is used—the light. The other wire goes back to the power source.)
1. Have the students look at the circuits shown and check the ones that are complete circuits. (Circuits 2, 3, and 4 are complete circuits and the bulb should light up. Circuits 1, 5, and 6 are incomplete circuits.)
 2. Divide the class into the small groups. Return to each group a flashlight bulb, a C or D battery, and a piece of noninsulated wire. The students are to check the answers they gave on the student sheet by constructing each illustrated circuit to see if the bulb lights. **(CAUTION—BATTERIES MAY GET HOT.)**
- C. Divide the class into small groups. Give each group two flashlight bulbs, two C or D batteries, four pieces of noninsulated wire and some masking tape. Give each group a copy of the student sheet "COMPARING CIRCUITS," included.
1. Before the students start to work, discuss with them series and parallel circuits. (Christmas tree lights make a good example.) Remind the students about the positive (+) and negative (-) terminals on the batteries. **(CAUTION—BATTERIES MAY GET HOT.)**
 2. Have the students build and compare the illustrated circuits and their own circuits (as directed). (The following results should be observed: Circuit 3—each bulb gets only half the voltage of the battery, so they both glow dimly. Circuit 7—both get almost the whole voltage, so they glow brightly. Circuit 4—the two batteries together produce twice the voltage, so the bulb glows very brightly. Circuit 5—the two batteries give the voltage of a single battery.)

III. Follow-up

- A. Have the students complete the student sheet "A-MAZE-ING CIRCUITS," included. (Correct completion of the maze will allow them to answer the questions with the word "electrons.")

- B. Have the students fill in the blanks.
1. _____ is the flow of electricity or the movement of electrons over a circuit.
 2. A _____ is a pathway for the passage of current.
- C. Have the students draw a simple circuit consisting of a flashlight bulb, a battery, and a piece of noninsulated wire.
- D. Have the students draw two series circuits and two parallel circuits consisting of some (but perhaps not all) of the following—2 flashlight bulbs, 2 batteries, and 4 pieces of noninsulated wire.

RESOURCES

Ardley, N. Discovering Electricity. New York: Franklin Watts Std., 1984.

Sund, R. B., D. K. Adams, J. K. Hackett, and R. H. Mayes. Accent on Science. Columbus, OH: Merrill, 1985.

ELECTRONS

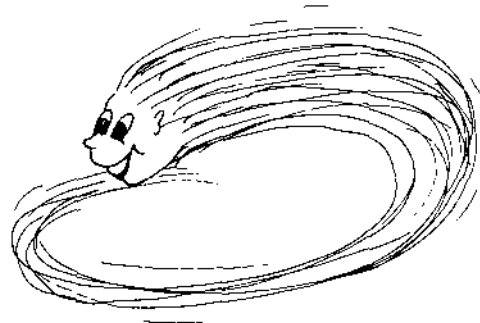
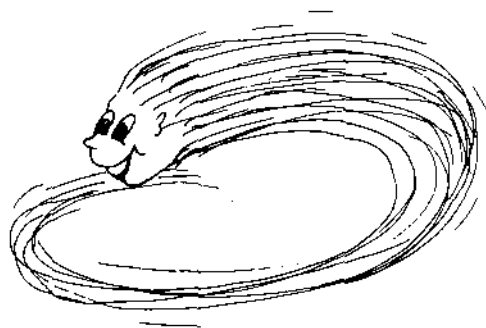
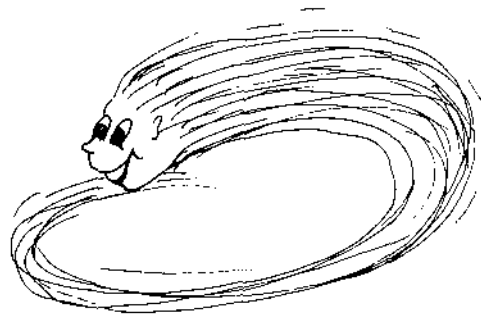
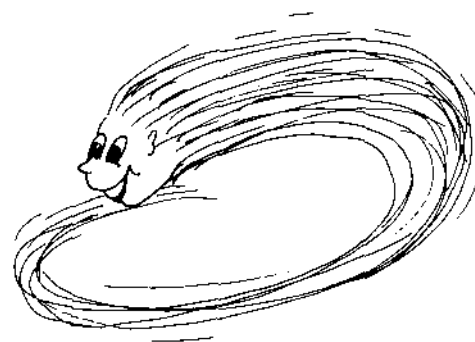
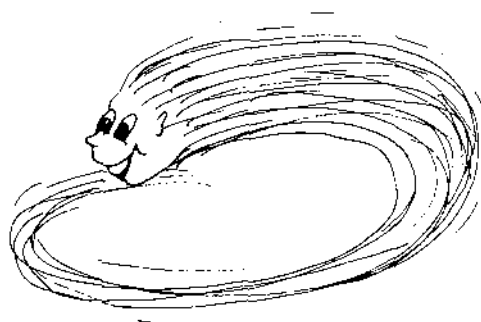
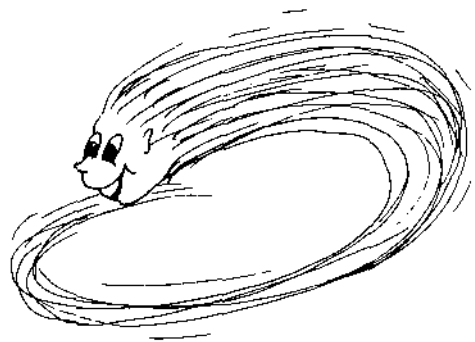

WHICH ONES WORK?

Look carefully at each circuit pictured below.

Decide which circuits are complete and would make the lights glow.

Check the boxes showing complete circuits.

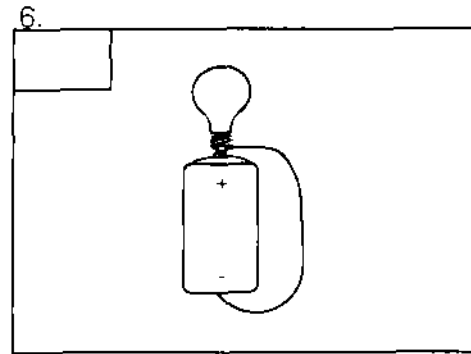
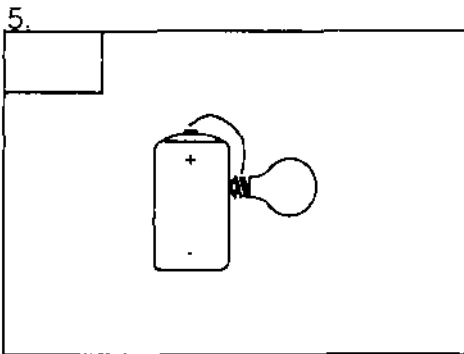
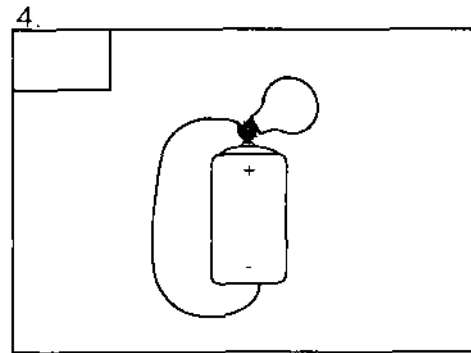
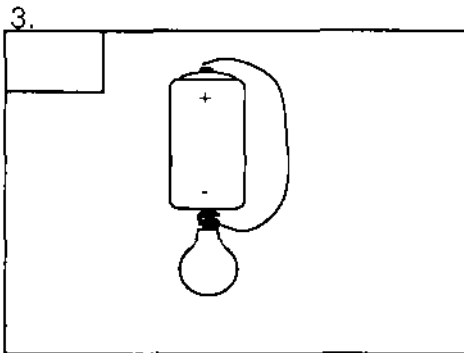
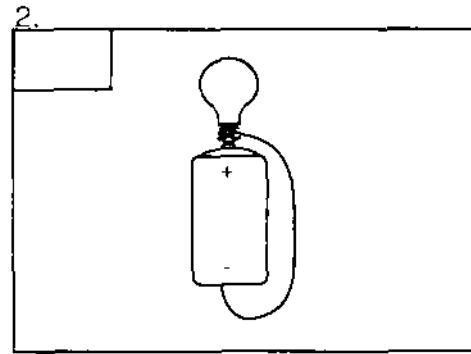
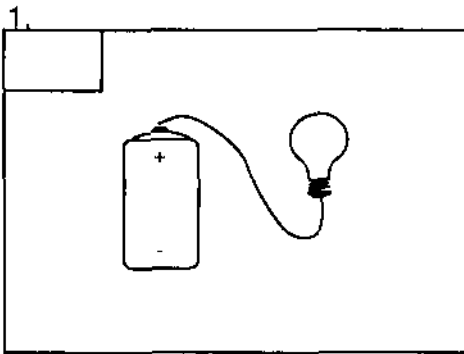

COMPARING CIRCUITS

Construct each of these circuits carefully. (Use masking tape to hold wires in place.)

As you build each circuit, note the brightness of the bulb. Color the bulbs on this worksheet to match the bulb's brightness.

1. Simple

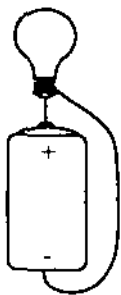

2. Simple

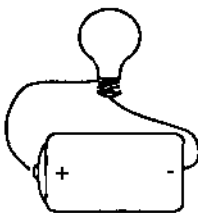

3. Series

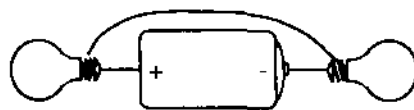

4. Parallel

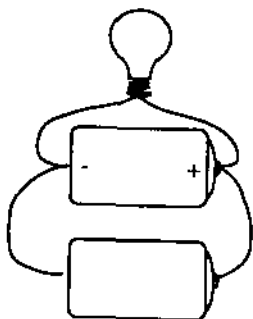

5. Series

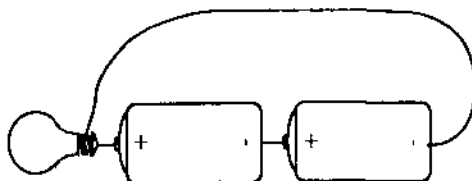

6. Series

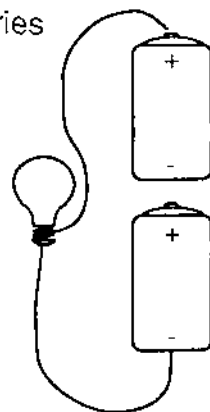

7. Parallel

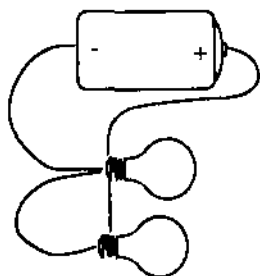

8. Try a series circuit of your own. (Draw it here.)

9. Try a parallel circuit of your own. (Draw it here.)

A-MAZE-ING CIRCUITS

Complete the maze. The correct path through the maze will lead to letters which will spell the word needed to complete this sentence.

Current electricity is the flow of _____.

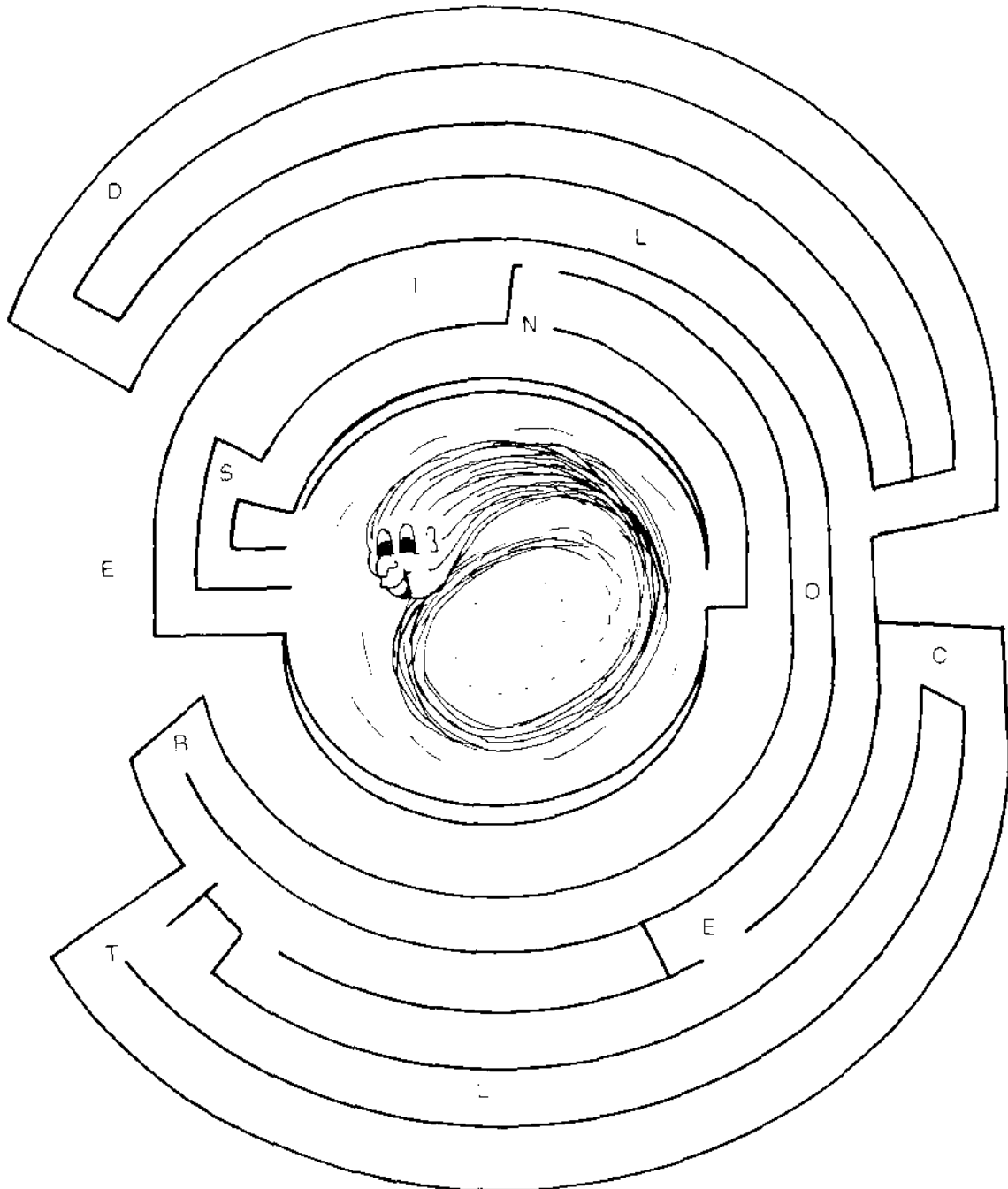

WHERE DOES IT ALL COME FROM?

OBJECTIVE

The student will do the following:

Name the energy sources from which electricity is produced.

SUBJECTS:

Science, Math

TIME:

120 minutes

MATERIALS:

construction paper (12" x 18"),
scissors, magazines, yarn, clothes
hangers, posterboard, markers, tape,
glue, student sheets (included)

BACKGROUND INFORMATION

Electricity is produced from several energy sources. Coal, oil, natural gas, water power, nuclear energy, and solar energy are all used to produce electricity.

Coal, our most abundant fossil fuel resource, has been a reliable energy source for many years. In the past, it was used primarily to heat homes, power factories, and run trains. While its use for these purposes has declined, it is now the fuel used in greatest amounts for the production of electricity.

Oil and natural gas are also fossil fuels; they are usually found together in the earth. Over the past 75 years, oil and gas have replaced coal as primary energy sources for industrial and residential use. They are used in some electric power plants.

The use of nuclear energy to produce electricity is relatively new. Nuclear power plants work like fuel-burning plants except that the heat used to boil water to steam is produced by a nuclear reaction (rather than by burning fuel).

Hydroelectricity, electricity produced from the power of falling water, accounts for about 13 percent of America's electricity. The force of falling water spins turbines, turning generators and converting mechanical energy into electrical energy. Hydroelectricity does not require any fuel and does not produce the environmental problems associated with fuel use.

Solar energy and other energy alternatives supply less than two percent of America's electricity. They may be thought of as being in the development stages, with several obstacles yet to be overcome.

Terms

coal: a major fuel resource formed from ancient plant remains that have partially decayed and, through time and pressure, become a carbon-rich rock material.

fossil fuels: fuels formed from the remains of ancient plants and animals; for example, coal, oil, or natural gas.

hydroelectricity: electricity produced by generators powered by the energy of falling water.

natural gas: a fossil fuel; a mixture of gases (mostly methane) often found with petroleum deposits.

nuclear energy: the energy (mostly heat) produced when the nuclei of uranium atoms are split; used to produce electricity.

oil: petroleum; a fossil fuel; a thick liquid mixture of substances formed from partially decayed ancient living things.

solar energy: the heat and light energy radiated from the sun.

PROCEDURE

I. Setting the stage

- A. Have six pieces of construction paper (12 x 18"). Write one of the six major sources of electricity on each sheet. Post these on a bulletin board or wall.
- B. Give each student a magazine and a pair of scissors. Instruct them to look through the magazines and cut out any pictures related to these energy sources. Allow 15 minutes for the students to find several pictures.
- C. Have the students divide their pictures as to the energy sources they represent. Have each student glue or tape his/her pictures to the proper sheet. A collage for each energy source will thus be constructed.

II. Activity

- A. Have the students make energy mobiles.
 1. Give each student a copy of the student sheet "SOURCES OF ELECTRICITY," included. Give the students the following instructions:
 - a. Using the circle pattern on the worksheet, make six circles from construction paper.
 - b. Color and cut out the symbols of the six sources of electricity.
 - c. Glue these to the construction paper circles.
 - d. Punch a hole in each circle and tie a piece of yarn to it. Make each piece of yarn a different length.
 - e. Tie the yarn pieces to the clothes hanger.
 2. Hang the energy mobiles in the classroom.
- B. Discuss with the students our use of energy sources to generate electricity.
 1. Make a drawing of the following bar graph on the board or a large piece of posterboard. Discuss bar graphs and what this graph is showing.

MAJOR SOURCES OF ELECTRICITY IN THE UNITED STATES (1981)

Percentage of
electricity generated

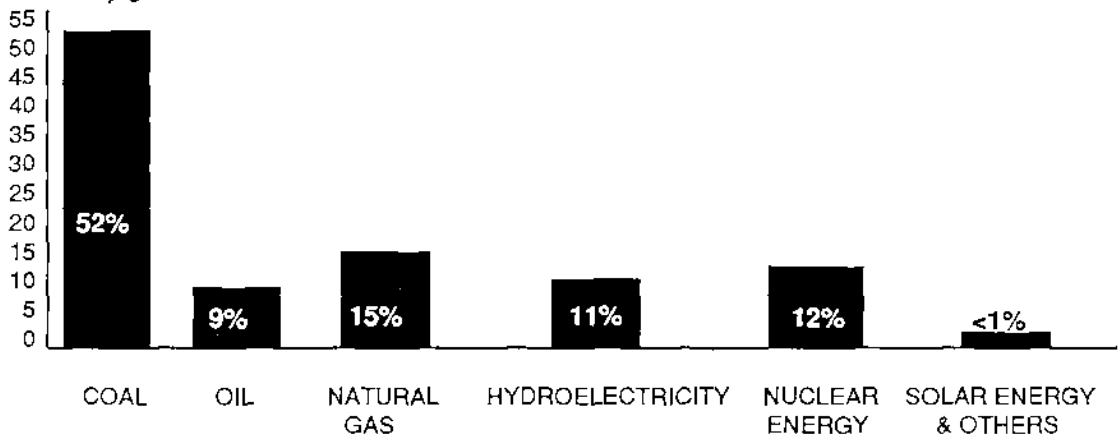

2. Give the students the student sheet "MAJOR SOURCES OF ELECTRICITY IN THE UNITED STATES," included. Have the students complete the pie graph using the information from the bar graph. (A teacher's key is provided.)
- C. Divide the students into six groups. Assign each group a source of electricity. Each group will write a booklet about its source. The booklet should include a definition of the energy source and a description of how it is used to produce electricity. The book should be illustrated. Provide books, magazines, newspapers, and/or library time for the groups. (You may want to have blank books made ahead of time or let the students come up with their own ideas.)

III. Follow-up

- A. Have each student complete the student sheet "WHERE DOES IT ALL COME FROM?," included.
- B. Have the students answer the following questions (using their pie graphs).
 1. What information does the graph supply?
 2. How many energy sources are shown on the graph?
 3. Which source is used most?
 4. Which source is used least?
 5. What percentage of electricity comes from hydroelectric sources?
- C. So that the students may demonstrate what they have learned, have the groups share their booklets with each other (or another class). You may want to display the booklets in the library or at a parent-teacher organization meeting.

RESOURCES

Fowler, J.M. Energy and the Environment. 2nd ed. New York: McGraw-Hill, 1984.

Houston Lighting and Power Company. "The Story Behind Your Light Switch." Houston, TX: Author, n.d.

Tennessee Energy Education Network. "Electricity" (a teacher information kit). (Address: Sixth Floor, 320 Sixth Avenue, North, Nashville, TN 37219, ATTN: Ms. Dawson. Telephone: 1-800-342-1340.)

SOURCES OF ELECTRICITY

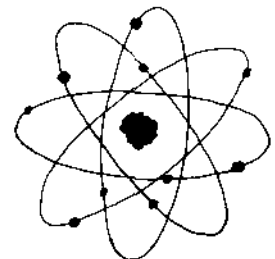
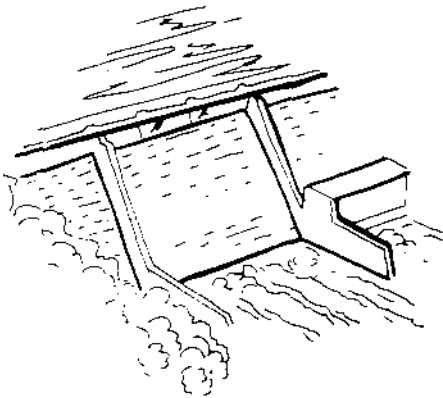
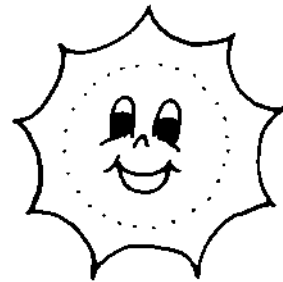
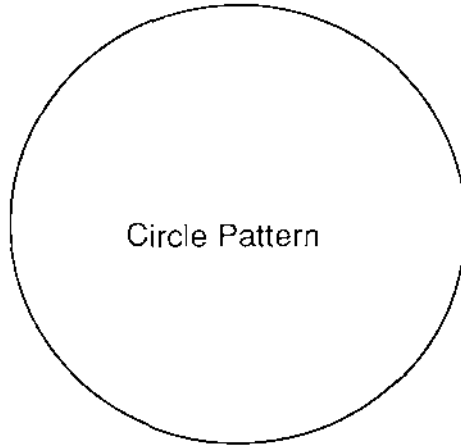
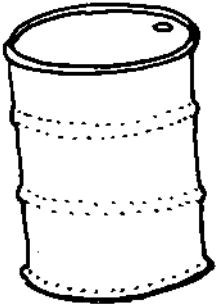

MAJOR SOURCES OF ELECTRICITY IN THE UNITED STATES

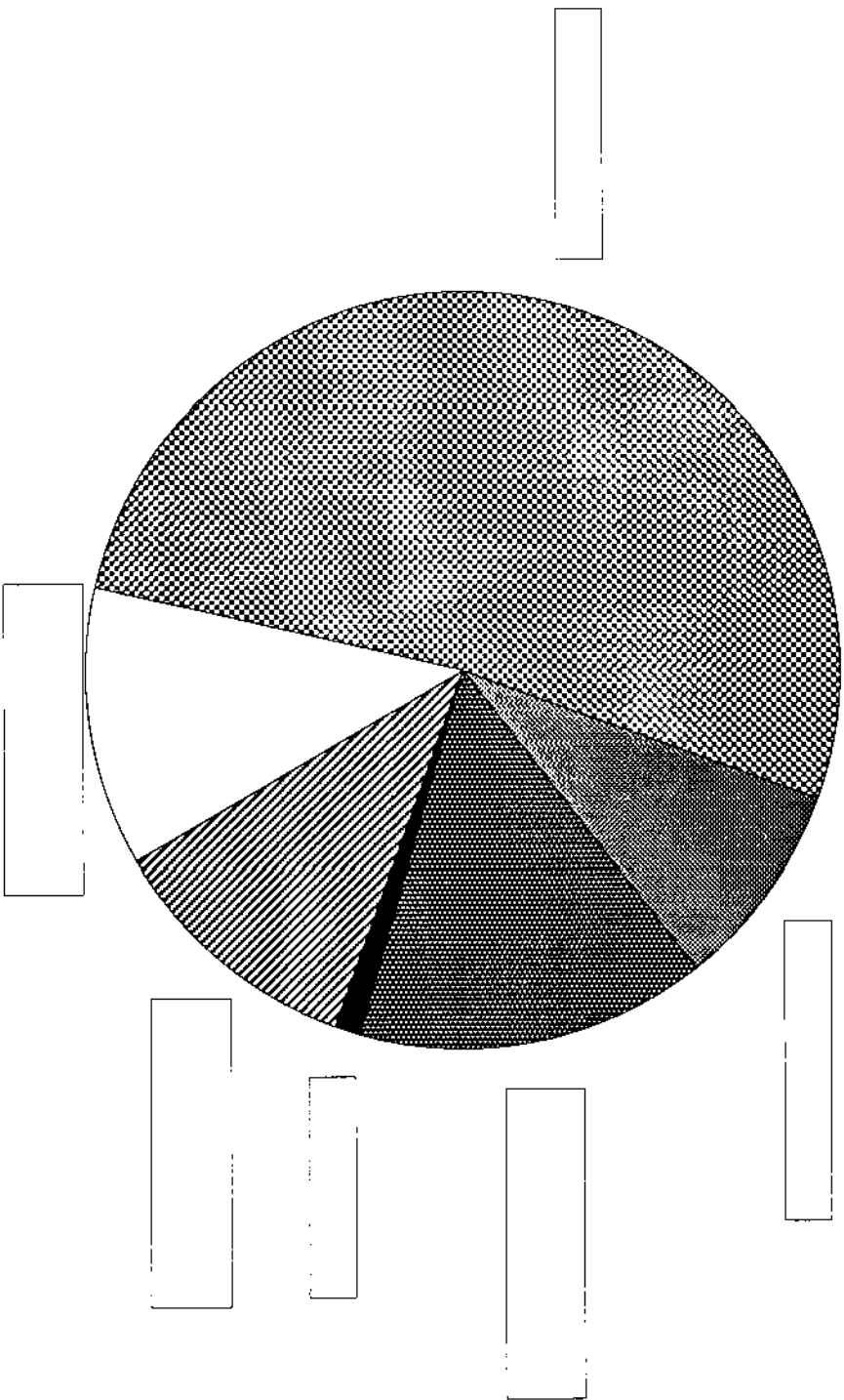

MAJOR SOURCES OF ELECTRICITY IN THE UNITED STATES

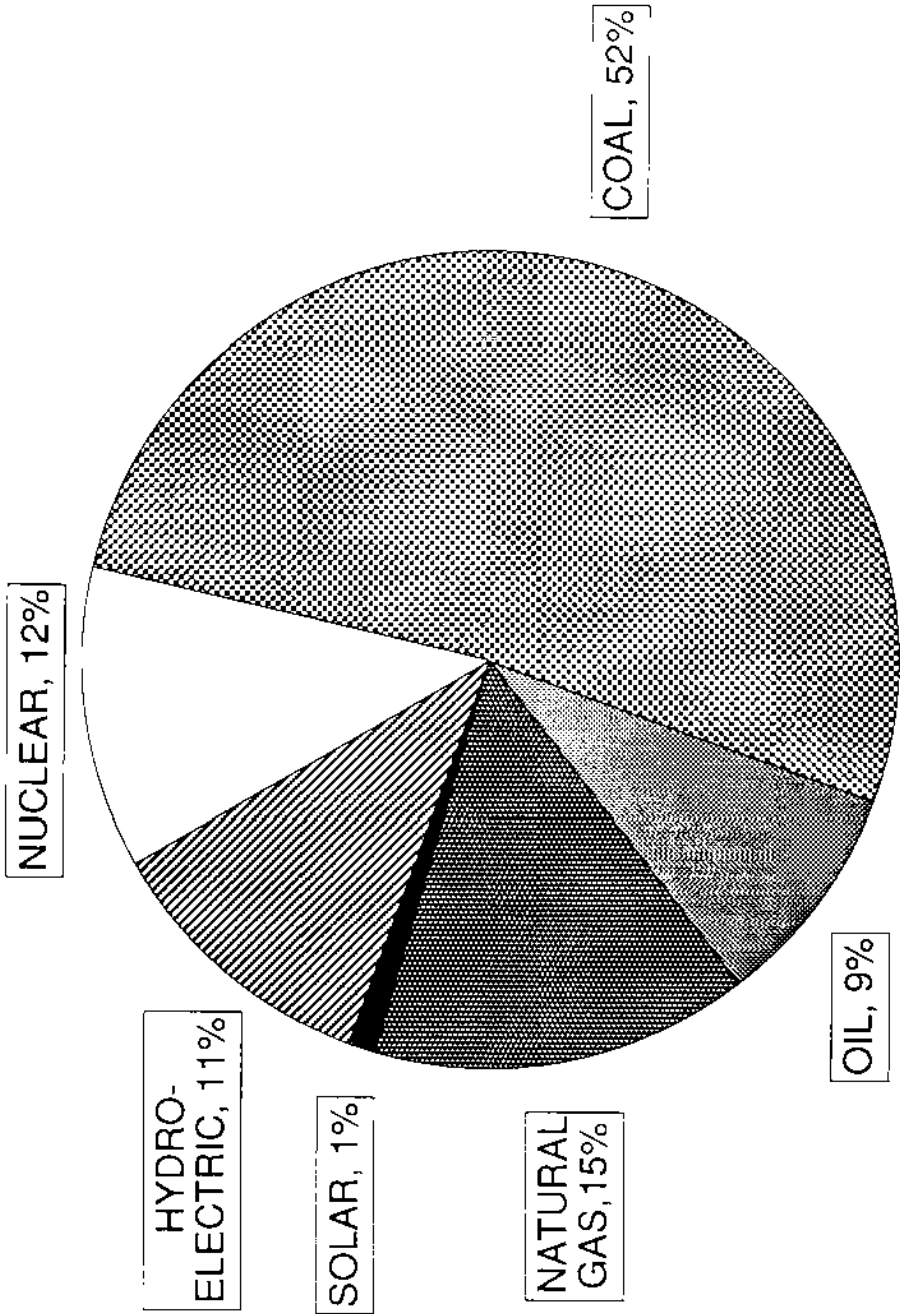

WHERE DOES IT ALL COME FROM?

Label each symbol. Use the following terms.

SOLAR ENERGY

COAL

NUCLEAR ENERGY

OIL

NATURAL GAS

HYDROELECTRICITY

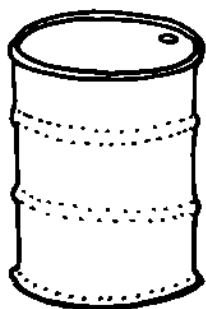
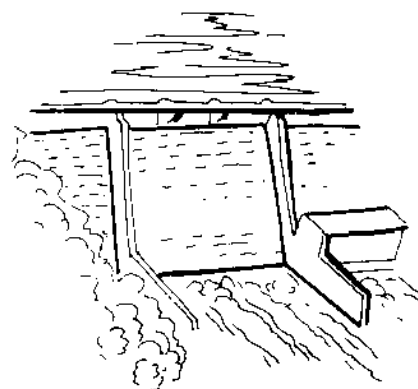
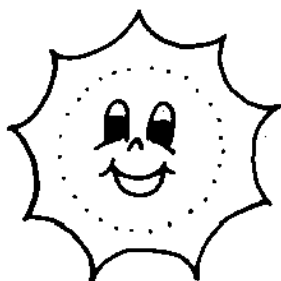
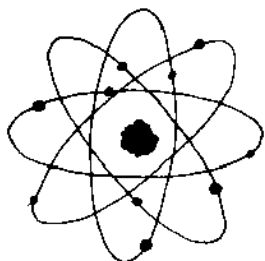

FROM THE GENERATOR TO YOU

OBJECTIVES

The student will do the following:

1. Observe how magnets are used to produce electricity.
2. Label a generator and its parts.
3. Describe the path of electricity from the generator to the home.

SUBJECT:

Science

TIME:

120 minutes

MATERIALS:

large sheet of paper, markers, wire, magnet, galvanometer (instructions included), cardboard tube, student sheets (included)

BACKGROUND INFORMATION

A generator is a machine that turns mechanical energy into electrical energy. (Energy cannot be created or destroyed, but it may be changed from one form to another.) The functioning of a generator depends on having an magnet. For powerful generators very strong electromagnets are needed.

A generator is essentially two wheels—one inside the other—inside a housing. The inside wheel is a magnet and is connected by a shaft to the turbine. When the force of jets of water or steam spin the turbine, the inside wheel of the generator spins, and its many lines of magnetic force are rapidly and repeatedly broken by the outside wheel.

This causes millions of electrons to push through the wires to which the generator is connected. The current is sent through wires from the power plant to the many places where electricity is used.

Terms

galvanometer: an instrument used to detect electric current.

generator: a machine that converts mechanical energy to electrical energy.

rotor: a generator's rotating core which is electromagnetized; its rotating magnetic field causes an electrical current in the stator.

stator: the stationary generator part within which the rotor spins; electric current is produced in the stator by the rotor's rotating magnetic field.

transformer: a device that changes the voltage of an electric current.

turbine: a bladed wheel made to turn by the pressure of steam, water, or air against its blades; it is connected to a generator and supplies the generator with the mechanical energy to be converted into electrical energy.

voltage: the force that pushes electric current along a circuit.

PROCEDURE

I. Setting the stage

- A. Hold up a piece of wire and a magnet. Ask the students how these objects could be used to do useful work. Encourage creative answers.
- B. Tell the students that, with a little modification, these objects could be used to provide the power to light a dark place, play a radio, heat water for bathing, or run a microwave oven to prepare a meal. Can the students guess what you are talking about? Tell them that wires and magnets are two of the basic materials needed to generate electricity.

II. Activity

- A. Demonstrate the production of electricity by the use of magnets and coils of wire.
 1. Have the following materials available—wire, a bar magnet, a galvanometer, and a cardboard tube. (If a galvanometer is not available, one can be constructed. See the teacher sheet "MAKING A GALVANOMETER," included.)
 - a. Wind about 20 turns of insulated wire around a cardboard tube. Leave the ends free.
 - b. Attach the ends of the wire to the free ends of the galvanometer's wire coil.
 - c. Push a magnet into the cardboard tube around which the wire is coiled.
 - d. Have the students observe the effect this has on the galvanometer.
 - e. Now pull the magnet out. What effect does this have?
 2. Let the students describe what happened. Tell them that when the magnet goes past the coils of wire, electricity is made. No electricity is made if the magnet does not move. The electricity travels through the wire and through the galvanometer. The galvanometer's needle moves when electricity goes through its coil of wire.
 3. Tell the students that a generator has parts that work like the magnet and coil of wire. If either the wire or the magnet moves, electricity is made. In a generator, the magnetized rotor spins, and electricity is induced in the stator's coil of wire.
- B. Introduce to the students the parts of the turbine generator.
 1. Make a transparency of the turbine generator from the provided master "THE TURBINE GENERATOR." Write the parts of the turbine generator—generator, rotor, stator, turbine, blade—on cards. Give the cards and tape or push pins to five different students.
 2. Project the picture of the turbine generator onto a blank wall or bulletin board. Have the students place the cards correctly on the bulletin board or wall as you read the teacher sheet "THE STORY OF THE TURBINE GENERATOR," included.
- C. To promote understanding of the transmission of electricity to the points of its usage, give the students the student sheet "FROM THE GENERATOR TO YOU," included. Discuss the diagram with them. Have the students make other diagrams or models of the path of electricity from the generator to the user.

III. Follow-up

Give the students the appropriate part(s) of the student sheet "MAKING ELECTRICITY," included. The answers are as follows:

- A. 1. magnets; 2. generator; 3. electricity; 4. wire.
- B. Make sure the students have labeled each part (generator, stator, rotor, turbine, blade).
- C. 1. power plant; 2. wires; 3. transformer (voltage up); 4. wires; 5. transformer (voltage down); 6. wires; 7. transformer (voltage down); 8. wires; 9. house.

IV. Extension

- A. Have the students "invent" their own kinds of generators.
- B. Choose supplementary exercises for the students from publications such as Electricity Experiments for Children (Reuben), textbooks, or other resources.

RESOURCES

Brandwein, P. F. Concepts in Science. New York: Harcourt Brace Jovanovich, 1975.

Reuben, G. Electricity Experiments for Children. New York: Dover, 1968.

Sund, R. S., D. K. Adams, J. K. Hackett, and R. H. Mayes. Accent on Science. Columbus, OH: Merrill, 1985.

Tennessee Valley Authority. "Electricity." N.p.: Author, 1983.

MAKING A GALVANOMETER

Make 2 boxes; one is Box No. 1, and the other is Box No. 2. Follow these directions to begin each box, then finish the boxes by following the directions given for Box No. 1 and Box No. 2.

1. Place a compass in the middle of a piece of cardboard, and trace around it.
2. Draw lines parallel to the edges of the cardboard so they frame the drawn circle.
3. Draw another set of lines parallel to those framing the circle. The distance between these lines should equal (or be more than) the measured depth of the compass frame.
4. Cut along the second set of lines on all 4 sides.

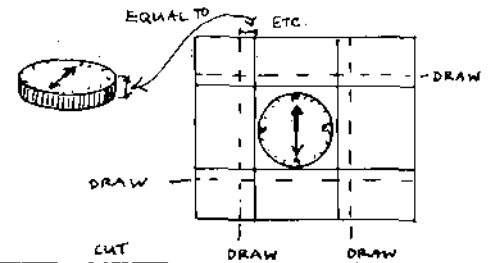
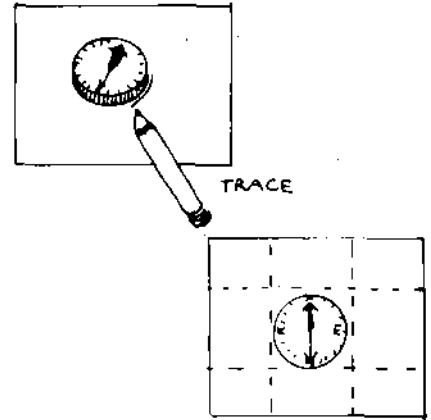

5. Cut out corners.

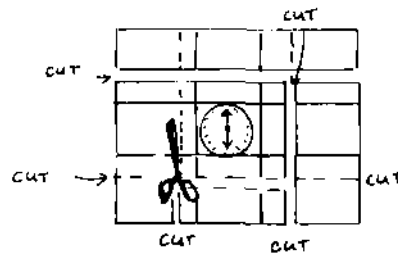
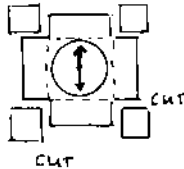

Box No. 1

1. On 2 opposite sides, make 2 cuts about 1/4 inch apart (as shown) to make tabs.
2. Fold cardboard up along the framing lines to form a box. Tape at corners. Fold tabs down.
3. Turn box upside down. This is the platform.

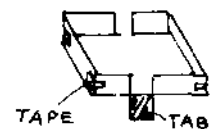
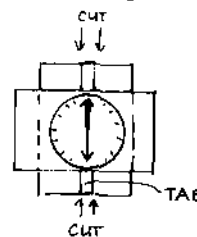

MAKING A GALVANOMETER

(continued)

Box No. 2

1. Fold cardboard up along the lines to form a box. Tape only 2 corners (as shown) leaving one side not taped.
2. Set box on top of platform. Tape the 2 tabs onto the sides of the top box.
3. Wind about 100 turns of wire around the platform and box, through the openings of the platform (as shown). Leave about 2 feet of wire sticking out at each end.
4. Tape wire to sides of box. Scrape off 1 inch of insulation from each end of wire.
5. Place compass, face up, in box. Fold cardboard end up and tape at corners. This is a galvanometer.

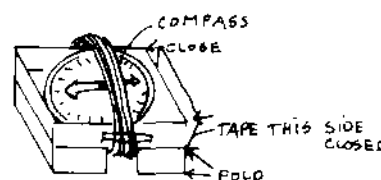
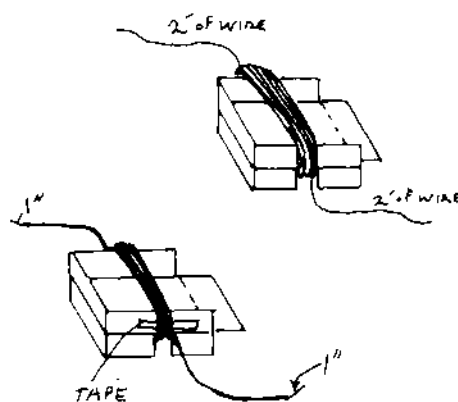
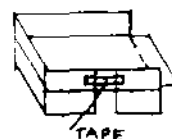

The Galvanometer

1. To use the galvanometer, rotate the entire box until the needle is under the wire, pointing in the same direction as the wire.
2. To demonstrate the flow of electric current, join the wire ends to the ends of the wire coiled around the cardboard tube. When the magnet is inserted into the tube, the compass needle will move to one side or the other. The movement of the needle shows that electrical current is flowing through the galvanometer's wire.

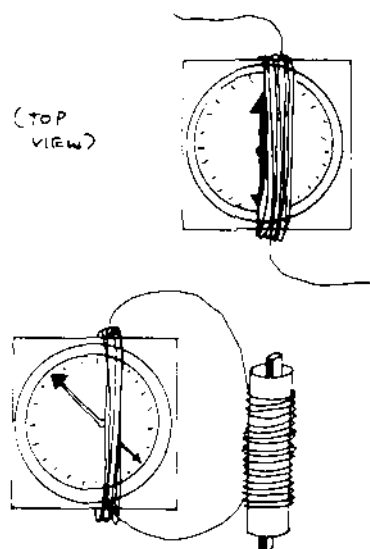

THE TURBINE GENERATOR

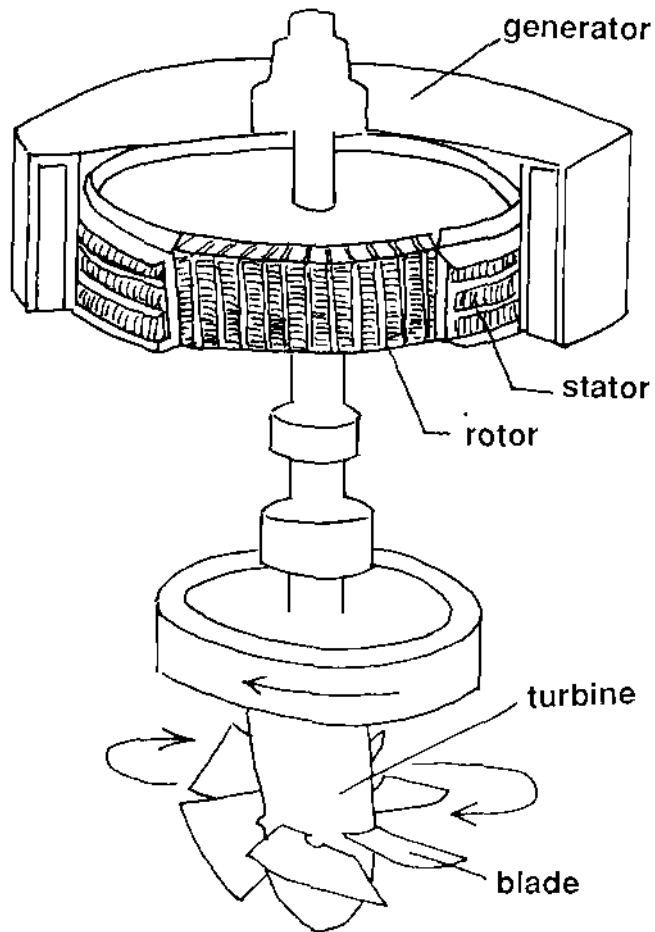

THE STORY THE TURBINE GENERATOR

In 1831, Michael Faraday, a British scientist, discovered that an electrical current is produced when a magnet is turned inside a coil of wires. Faraday's invention, which sat on a table top and was turned by hand, was the first electrical generator. Although much larger and more efficient generators have been developed, they still work on the same principle.

The two largest parts of the generator are the stator and the rotor. The stator is a stationary ring wrapped with coils of wire. The rotor is a wheel inside the stator and is also wrapped with wire. When a small electrical current passes through the coils of the rotor, it acts like a magnet. As the magnetized rotor spins, it produces an electrical current in the stator coils which can be collected and distributed to wherever it is needed.

Connected to the central shaft of the rotor is a device called a turbine. It has a series of specially designed blades. When water or steam is jetted against the blades, the turbine shaft turns and spins the generator's rotor.

FROM THE GENERATOR TO YOU

After electricity is made in a generator at a power plant, it goes through wires to the many places where it is used. The electricity is changed along the way by devices called transformers. Transformers change the voltage of the electricity. Voltage is how much "push" the electricity has. First, the voltage is made higher so that it can travel through the wires better. Then transformers nearer your home lower the voltage so the electricity can be used safely.

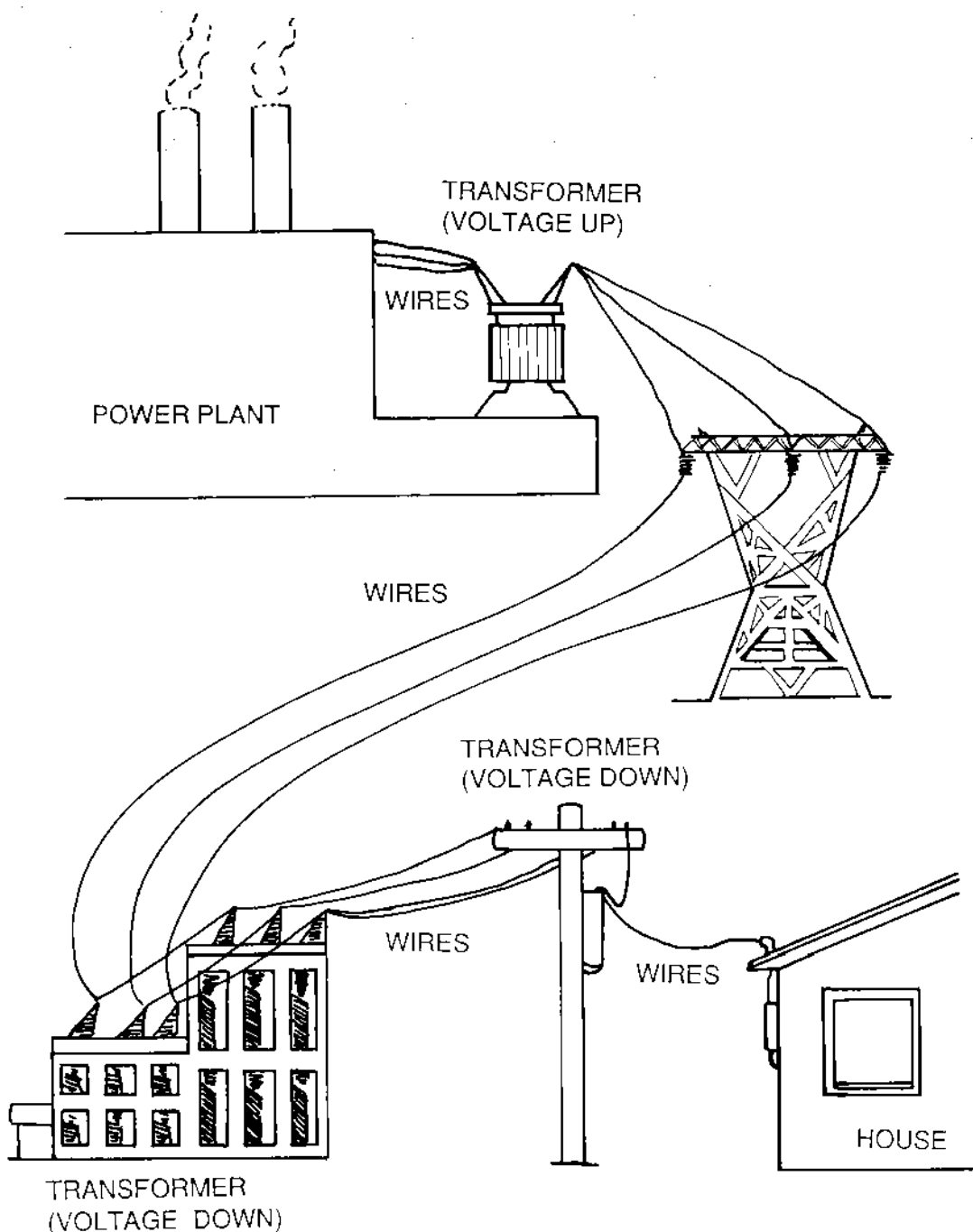

MAKING ELECTRICITY

A. Fill in the blanks. Choose from these words—electricity, generator, magnets, wire.

1. _____ are important in making electricity.
2. A _____ is a machine that makes electricity.
3. When a magnet is moved through coils of wire, _____ is made.
4. A generator has a magnet and coils of _____.

B. Label the parts of the generator. Choose from these words—blade, generator, rotor, stator, turbine.

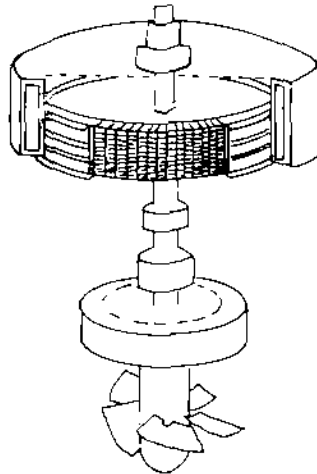

C. Put these terms in the correct numerical order to show electricity's transmission from where it is produced to where it is needed. Number from 1-9.

- | | |
|-------------------------------------|-----------------------------------|
| _____ wires | _____ wires |
| _____ transformer (voltage down) | _____ transformer (voltage up) |
| _____ house | _____ power plant |
| _____ wires | _____ wires |
| _____ transformer (voltage down) | |

ENERGY IN MOTION

OBJECTIVES

The student will do the following:

1. Define potential and kinetic energy.
2. Give examples of potential and kinetic energy.

SUBJECTS:

Science, Math

TIME:

60 minutes

MATERIALS:

stiff paper, 5 yo-yos, pins, thumb-tacks or tape, colored markers, paper cups, pencils, pictures showing examples of potential and kinetic energy, student sheets (included)

BACKGROUND INFORMATION

Energy is used when matter changes or is moved. The energy matter has when it is moving is called kinetic energy. A moving train has kinetic energy. A landslide has kinetic energy. Kinetic energy is called the energy of motion.

Not all energy is kinetic energy. Some matter is able to move or change something, but is not doing it at the moment. Matter that has stored energy is said to have potential energy. This means that piles of coal or wood have potential energy. (When they are burning, they have kinetic energy.) Likewise, something that is in a position from which it would be able to exert energy (for example, a ball held high in the air or water held behind a dam) has potential energy. Potential energy is called stored energy or the energy of position.

Terms

energy: the ability to do work.

kinetic energy: the energy of motion.

potential energy: stored energy, or the energy of position.

PROCEDURE

- I. Setting the stage
 - A. Introduce the concept of potential and kinetic energy by having the students do the following demonstration:
 1. Give each of five students a yo-yo. Have them yo-yo for the class.
 2. Tell the students that energy is the ability to do work. Ask if they see any evidence of energy. Many will cite the moving of the arms or the yo-yos. Tell the students that the movement of arms and yo-yos is called kinetic energy—the energy of motion.

3. Have the students with the yo-yos stop and just hold them in their hands. Tell the students another kind of energy is being demonstrated. Explain the concept of potential energy—stored energy.

B. Have the students think of other examples of kinetic and potential energy. List them on the board.

II. Activity

A. Play a game to help the students recognize potential and kinetic energy.

1. Display a chart like the following:

| ENERGY | |
|---------|-----------|
| KINETIC | POTENTIAL |

The chart can be drawn on a bulletin board or made on a large piece of posterboard. If done on posterboard, the chart can serve as a display when the game is completed.

2. Show the students a stack of pictures (cut from magazines) showing kinetic and potential energy.
 3. Divide the class into two teams. Have each team choose a picture and place it correctly on the chart. (Supply the teams with thumbtacks or tape.)
 4. Award one point for each correctly placed picture. If a picture is placed incorrectly, award no points. When all the pictures have been placed, the team with the most points wins the game.
- B. Have the students construct and use a pinwheel to demonstrate kinetic and potential energy.
1. Have each student construct a pinwheel using the student sheet "ENERGY WHEEL," included. (These need to be reproduced on heavyweight paper.)
 2. Give each student a paper cup. Have them fill their cups with water.
 3. Review the definitions for kinetic and potential energy. Write them on the board.
 4. Have the students state which kind of energy the pinwheels and the cups of water represent.
 5. Station the students at sinks or tubs, and have them pour the water over the pinwheels, stating which kind of energy the spinning pinwheels and the cups of pouring water represent. (If it is impractical to have the students do this, you may demonstrate it for them.)

C. Have the students solve an energy production problem.

1. Divide the students into pairs and give them this problem: How much water will it take to produce 100 units of energy if each turn of the pinwheel represents 5 units of energy?
2. Have the students use the pinwheel constructed in Activity B. One blade of the pinwheel should be colored a bright color (so that turns will be easier to count).

3. Provide each pair of students with a large cup of water.
4. Have the students develop a procedure that will allow them to solve the problem.

III. Follow-up

- A. Have the students complete the student sheet "ENERGY MATCH," included. The answers are as follows: kinetic—moving bicycle, waterfall, burning coal, moving ball, running horse; potential—batteries, pile of wood, stretched rubber band, can of gasoline, still water.
- B. Give each of the students a copy of the student sheets "ENERGY MAZE #1" and "ENERGY MAZE #2," included. Have them complete the mazes. (The first maze spells "kinetic" and the second, "potential.")
- C. Have the students answer the following questions.
 1. What in your experiment represented potential energy? (still pinwheel, cup of water) kinetic energy? (turning pinwheel, pouring water)
 2. Can you think of any real-life situations which are related to your experiment? (windmills, waterwheels, hydroelectric power)
 3. List some examples of kinetic and potential energy which could be found in your community.

RESOURCES

Sund, R. B., D. K. Adams, J. K. Hacket, and R. H. Mayes. Accent on Science. Columbus, OH: Merrill, 1985.

Zinn, G.A. Steps in Science. New York: Standard, 1974.

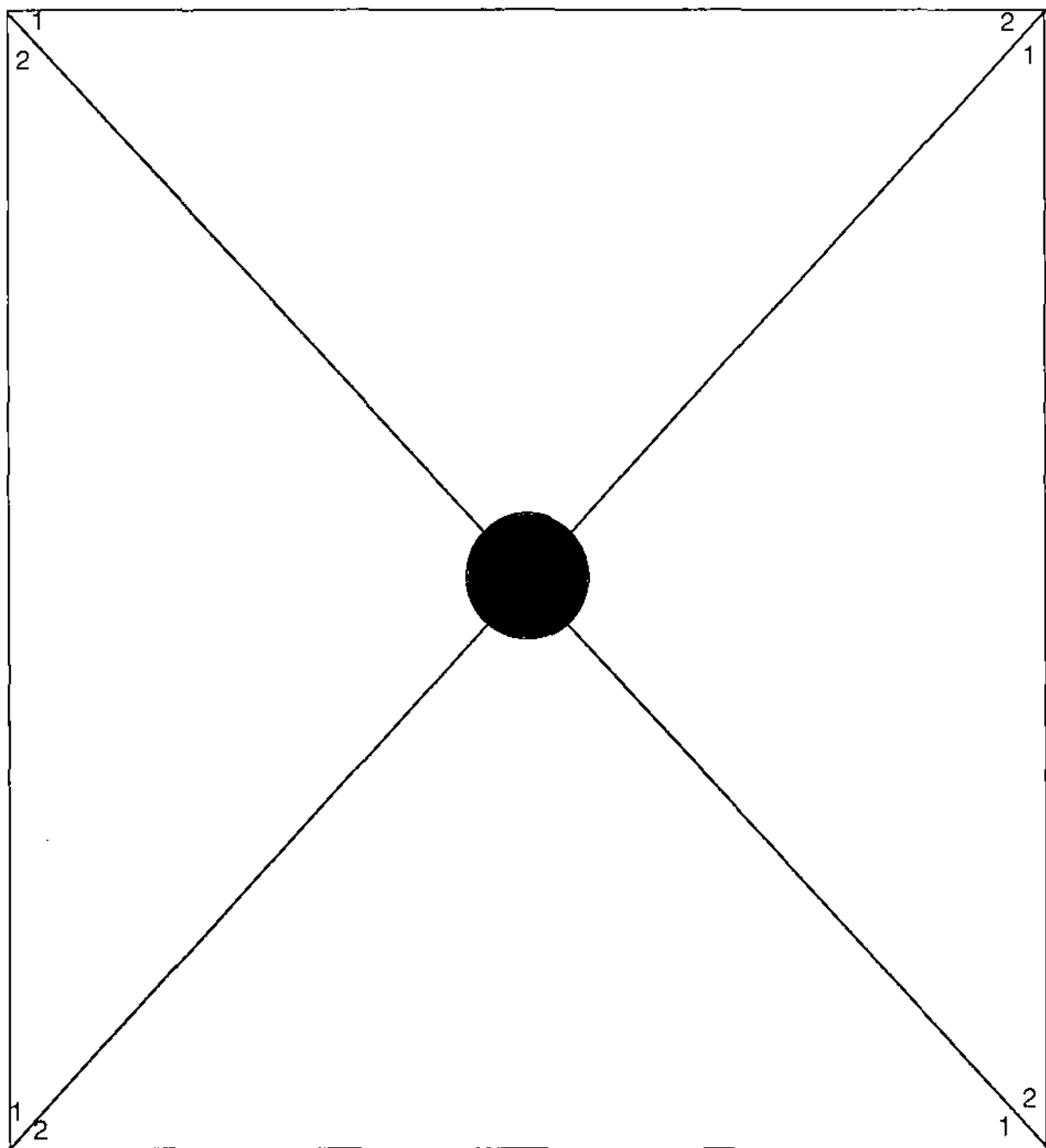
ENERGY WHEEL

1. Cut out the square above.
2. Cut along the lines from each corner to the circle. (Do not cut into the circle.)
3. Fold all corners marked number 1 to the center.
4. Push a pin through the center and all four corners and into a pencil eraser, attaching the pinwheel to the pencil.

ENERGY MATCH

Draw lines to match the kind of energy to the examples.

| | |
|-----------|-----------------------|
| | moving bicycle |
| | batteries |
| | pile of wood |
| Kinetic | waterfall |
| | burning coal |
| | stretched rubber band |
| Potential | moving ball |
| | can of gasoline |
| | running horse |
| | still water |

ENERGY MAZE #1

The correct path through the maze will lead to letters spelling the word which will complete the following sentence.

The energy of moving matter is called _____ energy.

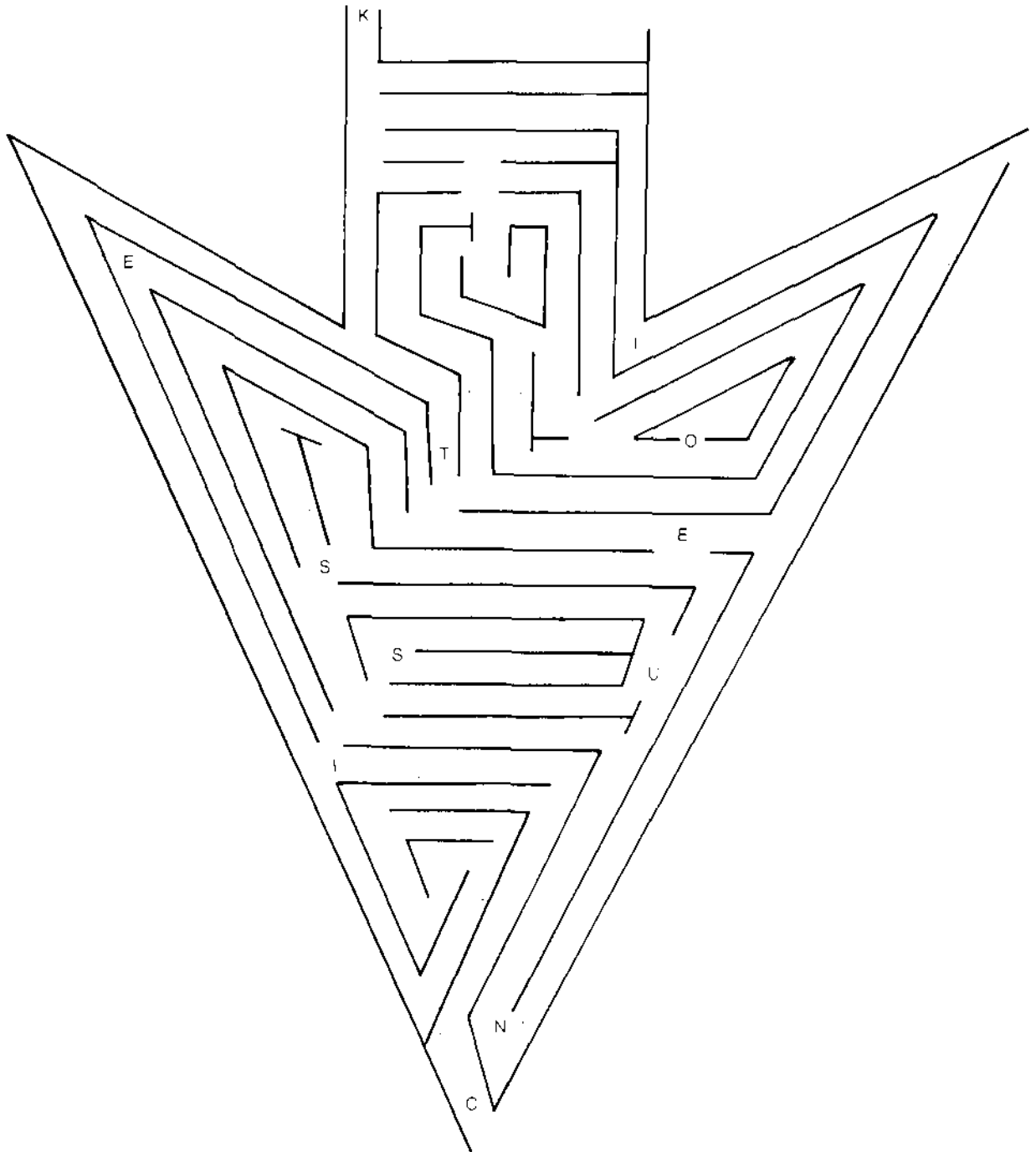

ENERGY MAZE #2

The correct path through the maze will lead to letters spelling the word which will complete the following sentence.

Energy which is stored is called _____ energy.

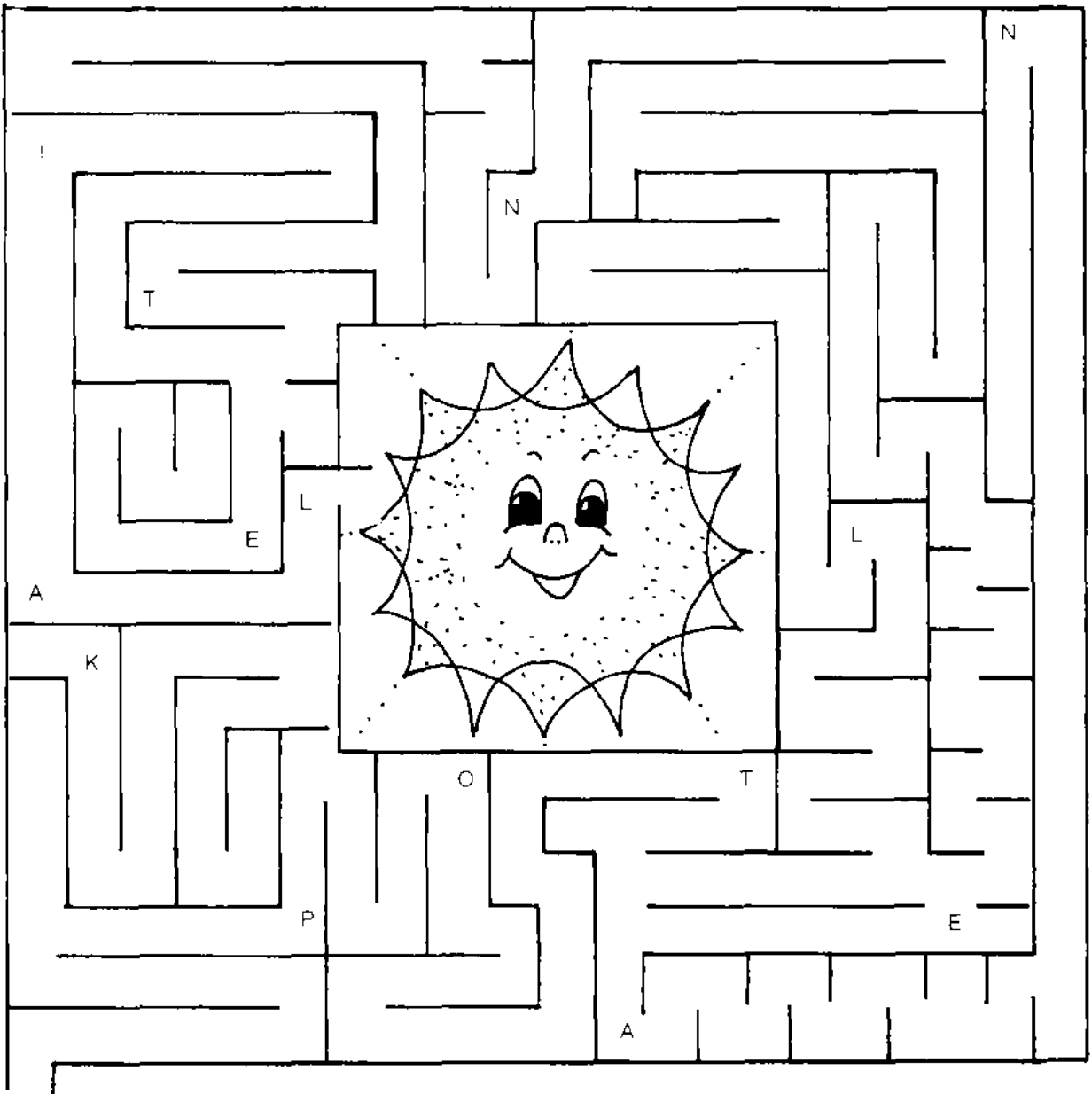

GLOSSARY

attract: to pull closer.

chemical energy: energy stored in matter because of its composition; energy that is released when compounds change; e.g., the energy stored in fuel.

circuit: a path for the flow of electrical current; composed of elements such as a source of electricity, something that uses electricity, and the wires connecting them.

coal: a major fuel resource formed from ancient plant remains that have partially decayed and, through time and pressure, become a carbon-rich rock material.

compass: an instrument used for determining geographical directions by means of a pivoting magnetic needle (which always points north).

conductor: material through which electricity can flow.

current electricity: the flow of electricity; the movement of electrons through a circuit.

electrical energy: energy produced by electrons pushing through wires.

electromagnet: a soft iron core wound with a coil of wire; it becomes magnetic when an electric current passes through the wire.

energy: the ability to do work.

energy chain: a series of energy transformations from one form to another.

fossil fuels: fuels formed from the remains of ancient plants and animals; for example, coal, oil, or natural gas.

galvanometer: an instrument used to detect electric current.

generator: a machine that converts mechanical energy to electrical energy.

heat energy: the internal energy of a substance or object due to the movement of its particles.

hydroelectricity: electricity produced by generators powered by the energy of falling water.

insulator: material through which electricity cannot flow easily.

kinetic energy: the energy of motion.

light energy: a form of energy that travels in waves and can be detected by the unaided human eye.

magnetic energy: the energy of attraction for iron and similar materials; such materials may have this energy naturally or it may be induced in them (as with an electromagnet).

magnetic field: the space around a magnet in which there is magnetic force.

magnetism: a magnet's force of attraction.

mechanical energy: energy possessed by the moving parts of machines.

natural gas: a fossil fuel; a mixture of gases (mostly methane) often found with petroleum deposits.

nuclear energy: the energy released when the nuclei of uranium atoms are split.

oil: petroleum; a fossil fuel; a thick liquid mixture of substances formed from partially decayed ancient living things.

parallel circuit: a circuit in which the elements that use electricity are arranged so the same voltage is applied at each one; that is, a circuit that consists of more than one path through which electricity can flow.

poles: the ends of a magnet; designated "north" and "south."

potential energy: stored energy, or the energy of position.

repel: to push away.

rotor: a generator's rotating core which is electromagnetized; its rotating magnetic field causes an electrical current in the stator.

series circuit: a circuit in which all the elements that use electricity are connected one after the other so that the current's voltage is divided among them; that is, a circuit that consists of only one path through which electricity can flow.

solar energy: the heat and light energy radiated from the sun.

sound energy: the form of energy which travels in waves and causes the vibration of particles of air, water, or solids; detected by the ears.

stator: the stationary generator part within which the rotor spins; electric current is produced in the stator by the rotor's rotating magnetic field.

transformer: a device that changes the voltage of an electric current.

turbine: a bladed wheel made to turn by the pressure of steam, water, or air against its blades; it is connected to a generator and supplies the generator with the mechanical energy to be converted into electrical energy.

voltage: the force that pushes electric current along a circuit.

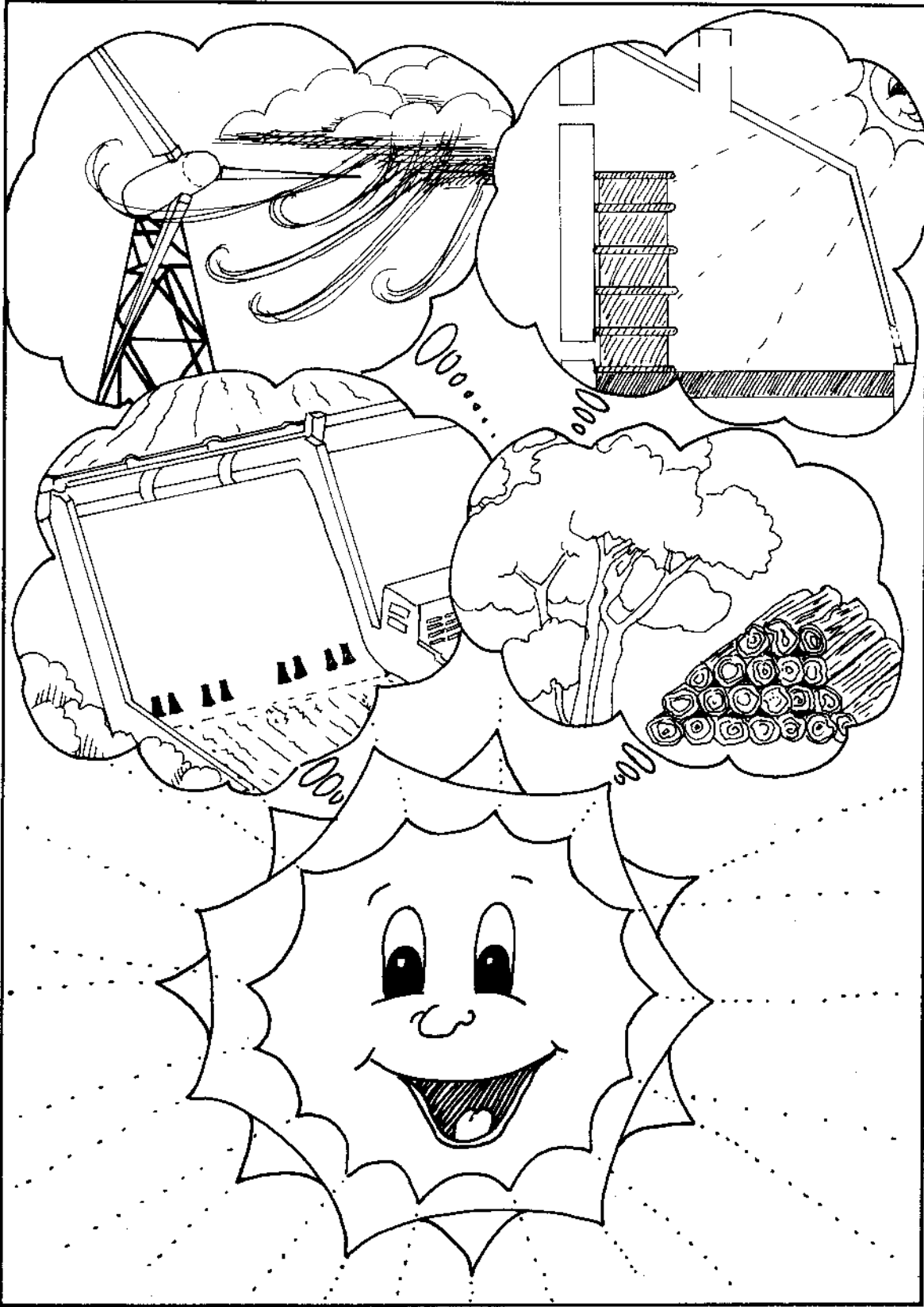

A BOX OF SUNSHINE

OBJECTIVES

The student will do the following:

1. Explain why seasons occur.
2. Define solar energy.
3. Demonstrate how solar energy can be trapped.
4. Construct a simple solar air heater.

SUBJECT:

Science

TIME:

150 minutes

MATERIALS:

glass jars with lids, scissors, glue or tape, razor knife, cardboard, thermometers, styrofoam cups, disposable pie pans, flat black paint, newspaper, measuring cups, plastic wrap, watch, yardstick, paint brushes, shellac, thumbtacks, scissors, string, duct tape, masking tape, student sheets (included)

BACKGROUND INFORMATION

People have been using the sun's warmth for thousands of years. In ancient civilizations in many places around the world, people learned how to build their homes and other buildings so that they could maximize the sun's warmth in the wintertime and minimize it in the summertime. More recently, we have learned to build devices that trap the sun's warmth, making use of "free" energy from the sun—rather than a fuel—to warm water or air. These solar collectors can be built a number of different ways and may serve a variety of purposes. We have also learned more about designing buildings to take better advantage of solar energy.

Effectively collecting the sun's warmth means that the device or building trapping the solar energy must be positioned so that it receives the maximum amount of energy in the winter—when our Northern Hemisphere is tilted away from the sun, making its warmth less intense. The collector or structure must be faced with a material that lets the sun's rays enter but does not let their warmth escape; glass is the most commonly used material. The collector or structure also usually has a material that helps absorb heat energy. For example, black surfaces absorb heat very well.

Terms

solar collector: any device used to trap the sun's energy and change it into heat energy.

solar energy: the energy we get directly from the sun's rays, especially the heat energy we can trap and use.

passive solar system: a device or structure that does not require mechanical parts to collect, store, and make use of solar energy.

PROCEDURE

I. Setting the stage

A. Examine with the students the seasonal variation of the sun's path across the sky.

1. Use a globe and a flashlight to help them understand how the tilt of the earth on its axis causes seasons. In winter, the sun appears lower in the sky because the northern hemisphere is tilted away from the sun. The heat of the sun is spread out more—is less intense—than it is in the summer. The opposite is true in summer, when the sun appears higher in the sky. The differing tilt of the earth makes the land and seas warmer in the summer and cooler in the winter. Note that calendars are just our way of measuring the time it takes for all these things to happen.
2. Distribute copies of the student sheet "THE SUN'S DAILY PATH," included. Have the students examine the diagram. Discuss it with them, checking their understanding of it.

B. Tell the students that passive solar design principles have been known and used for a long time. This means that for thousands of years, people have known how to construct buildings so that they trap heat when it is needed in the winter but prevent heat gain in the summer. For example, ancient Indians in the American Southwest built homes into the south face of cliffs, so that they would be heated by the winter sun, but sheltered from the summer sun. Some ancient Greek homes had overhanging ledges or roofs for summer shade but winter heat collection. Some of the famous Roman baths were heated by the sun.

1. Have the students do the activity for which the directions follow. (NOTE: Better results will occur during fall and spring months rather than winter months unless the classroom has a south-facing window.)
 - a. Divide the students into groups of three or four students each. Give each group two thermometers and a glass jar with a lid.
 - b. Make a chart that looks like the one below on the chalkboard. Have the students copy the chart and record their data on their copies.

| Time | Temp. inside jar | Temp. outside jar |
|---------|------------------------|-------------------------|
| 0 min. | | |
| 5 min. | | |
| 10 min. | | |
| 15 min. | | |
| 20 min. | | |

- c. Each group is to place a thermometer in the glass jar and screw on the lid. Each jar is to be placed in direct sunlight, and a second thermometer placed next to the jar.
 - d. The students are to read both thermometers and record the beginning temperatures at 0 minutes. They are to read and record the temperatures every 5 minutes for 20 minutes.
2. Have the students draw conclusions about the activity. Ask them the following questions:
 - a. What happened to the temperature inside the glass jar during the 20-minute period?
 - b. What happened to the temperature outside the jar during the same time?

- c. Which temperature was higher after 20 minutes?
 - d. How did the glass jar affect the heat from the sun?
3. Tell the students that some people use heat from the sun to heat their homes. Ask them to find out about solar collectors. How are they like the jars used in this activity?

II. Activity

A. Have the students investigate collecting solar energy further.

1. Discuss how the angle of the sun's rays is related to temperature. You might have the students repeat the experiment above at different times of the day (e.g., early in the morning, at midday, and at midafternoon).
2. Have the students do the activity for which the directions follow.
 - a. Divide the students into groups of three or four and give each group a watch, two thermometers, two styrofoam cups, and some water .
 - b. Make a data chart on the board for the students to copy and use. (See I.B. for an example.)
 - c. The students are to fill both cups with equal amounts of cold water and place a thermometer in each one.
 - d. They are then to measure the temperature for each cup of water and record it. After putting one cup in the shade and one in the sun, they are to check and record both temperatures after 5, 10, and 15 minutes.
3. Have the students draw conclusions about the activity. Have them answer the following questions:
 - a. Where is it cooler (sun or shade)?
 - b. How many degrees cooler is it?
 - c. What happens to water standing in the sun all day?
 - d. Would solar energy be a good means of heating a house in the woods?
4. Explain that the sun's energy can be captured most effectively by solar collectors placed on the south side of a house or other building, because the south side receives the most direct sunlight. Of course, it is very important that there is no shade to block the sun's rays.

B. Have the students build and test simple solar collectors.

1. Share the following information on solar heating: Huge amounts of energy come from the sun. We can make use of this energy by changing it into heat for our homes. Some houses have boxes on their roofs. These boxes, called solar collectors, have glass tops and are black inside. Water flows through them and is heated during the day by the sun's rays. When it is warmed, the water then flows to an insulated tank where it is stored for later use.

2. Have the students do the activity for which the directions follow.

- a. Divide the students into groups of three or four each. Give each group both two disposable pie pans, flat black paint (not water soluble), a thermometer, a measuring cup, some clear plastic wrap, tape, two styrofoam cups, and a small stack of newspapers. (NOTE: To save time, you may want to spray paint the pans flat black beforehand.)
- b. Make a chart on the chalkboard like the one below. The students are to copy it and record their data on their copies.

| | Temperature | |
|--------|-------------|---------|
| | Begin | 15 min. |
| Sunny | | |
| Shaded | | |

- c. Each group is to paint both pans black and let them dry.
 - d. They are then to pour 1/3 cup water into each pan, and to measure and record the temperatures of each on the chart. The plastic wrap is to be used to cover the pans tightly. (The wrap should be taped to ensure a tight seal.) One pan is to be set in a sunny area and the other in a shaded area. Both pans should be set on several sections of newspaper to keep the ground's temperature from affecting that of the water. After 15 minutes, each group is to pour the water into the two cups and measure the temperatures.
3. Have the students draw conclusions about the activity. Have them answer the following questions:

- a. Which pan had hotter water?
- b. Why were the pans painted black?
- c. For what purpose was the plastic wrap?
- d. Why pour the water into cups before measuring the temperature?

C. Have the class build simple solar air heaters.

1. Divide the class into groups of five or six students each. Each group is to construct a solar air heater, using the directions on the student sheet "BUILD A SOLAR AIR HEATER," included. Provide each group with cardboard, a yardstick, shellac, flat black paint, paintbrushes, thumbtacks, scissors, duct tape, plastic wrap, a razor knife, and masking tape.
2. When the air heaters have been completed and tested as directed on the student sheet, have the students evaluate the performance of their heaters.

III. Follow-up

A. Have the students demonstrate knowledge of the following solar energy concepts:

1. Explain the seasons. (In winter, the sun is low in the sky and its heat is spread out more— is less intense—than it is in summer. In summer, the sun appears higher in the sky. Its rays are more direct, making the land and seas warmer in the summer than in the winter. These changes are due to the differing tilt of the earth on its axis. In winter the Northern Hemisphere is tilted away from the sun; in summer, it is tilted toward the sun.)

2. Define solar energy. (Solar energy is the energy we get from the sun's rays; it can be used to heat homes or water.)
- B. Have the students explain passive solar heating. (A passive solar heating system is one which relies largely on the natural flow of heat to collect and store heat from the sun's rays. It does not have pumps, fans, or other devices to help in this process. Simply put, a passive solar system is a building or a device that traps solar energy for use.)
 - C. Have the students list some important factors in collecting solar energy. (something to trap heat [a collector], a location free from shading, black surfaces to increase heat collection, and so forth)

IV. Extension

- A. Some students might collect pictures and newspaper or magazine articles related to solar energy. These should be displayed and a presentation made about them. Some may wish to make a scrapbook on solar energy.
- B. Students may make crossword puzzles or word search puzzles about solar energy. These may be duplicated and copies given to classmates or other teachers' students.
- C. Students may read books or stories about solar energy. This activity should be completed by one of the following:
 1. Designing a poster advertising the books they read.
 2. Making a "filmstrip" about the book on a long sheet of white paper. (Adding machine tape works well.)
 3. Writing a summary of the book.
- D. Some students may wish to research solar energy-related careers. (This may lead to an investigation of possible solar energy applications for the future.)

RESOURCES

- Fogel, B. Energy Choices for the Future. Franklin Watts, NY: Impact, 1985. (pp. 57-62)
- Mallinson, Mallinson, Valentino, and Smallwood. Science - Grade 4. Morristown, NJ: Silver Burdett, 1984. (p. 146)
- Mason, J. Power Station Sun. East Grinstead, Sussex, England: BLA, 1987. (p. 7)
- National Appropriate Technology Assistance Service. Connections: A Curriculum in Appropriate Technology for 5th and 6th Grades. N.p.: U.S. Department of Energy, 1986. (Address: NATAS, P.O. Box 2525, Butte, MT 59702-2525. Telephone: 1-800-428-2525.)
- "Science Scene, Solar Fun." The Mailbox, October 1987.
- Spetgang, Tilly, Wells, and Malcolm. The Children's Solar Energy Book. New York: Sterling, 1982. (pp. 65, 89)
- Thompson, Hancock, Witte, and Associates. Passive Retrofit Handbook. Atlanta: Southern Solar Energy Center and U.S. Department of Energy, 1980.

THE SUN'S DAILY PATH

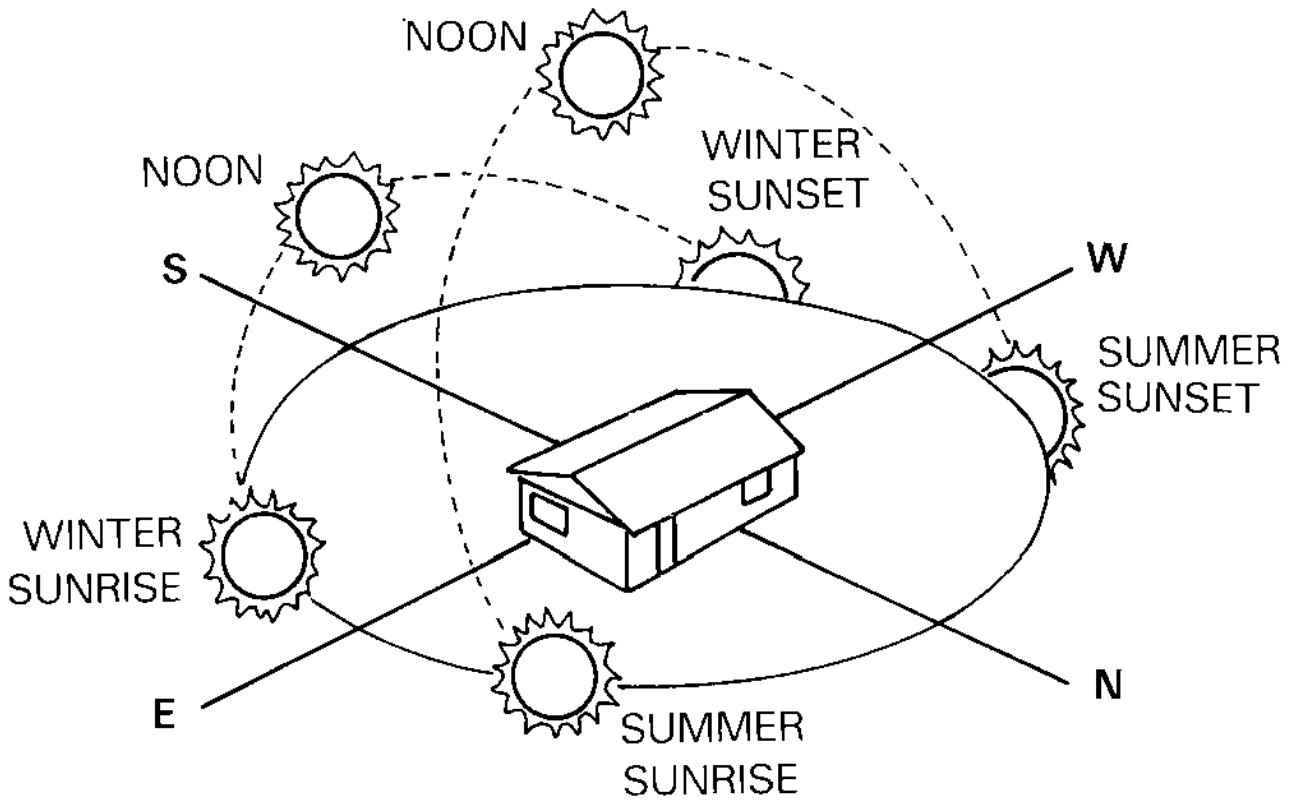

BUILD A SOLAR AIR HEATER*

I. Prepare to build a solar air heater.

- A. Use a compass to find a window that faces due south.
- B. Measure the window to be used and get a piece of cardboard large enough to cover it with a least 5 inches to spare all the way around.
- C. Mark off the exact size of the window on the cardboard. Add 5 inches all the way around the window size and cut out the heater as shown in the diagram.
- D. Fold back 5-inch flaps and test the box-like heater for a snug fit inside the window frame.
- E. Cover one side of the cardboard with shellac. After letting it dry for 5-7 hours, paint it with flat black paint. Let the paint dry completely before going on.

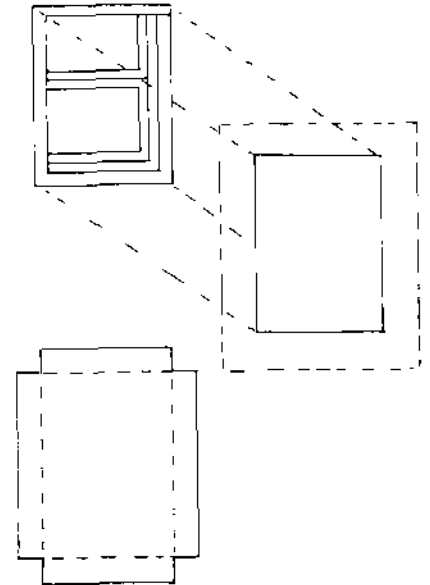

II. Make the vent holes in the heater.

- A. Cut vents at least 3 inches high near the top and bottom of the heater, as shown.
- B. Push thumbtacks into the cardboard around the vent holes as shown. (Put them in the unpainted side.)
- C. Weave some thin string around the thumbtacks, crossing the vent holes.
- D. Cover the thumbtacks with strips of silver duct tape to keep them from falling out.
- E. Get some thin plastic film (like food wrap—do not use wax paper) and cut strips large enough to cover the vent holes.

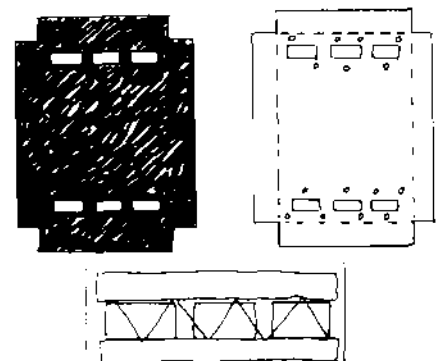

BUILD A SOLAR AIR HEATER*

(continued)

- F. Tape the plastic to the outside (black side) of the bottom vents and to the inside (string side) of the top vents.

III. Install the heater in the window.

- A. Place the heater—black side facing the window, top vents up (so that the plastic flaps hang down over the vent holes)—inside the window frame. Then tape it to the window frame with masking tape.
- B. Leave an air space between the glass and the cardboard, but none around the edges of the cardboard.
- C. After the heater has been in place for several class periods, check to see if warm air is coming out of the top vents.
- D. Don't leave the masking tape on the window frame too many days; it may pull the paint off with it when you remove it.
- E. A smaller model can be made using a cardboard box taped to the window, leaving an airspace between the glass and the back of the box. Just follow the above directions.

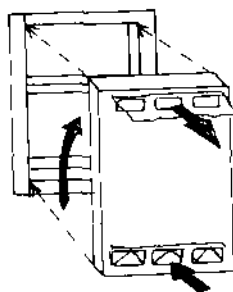

* Adapted from Connections, developed by NATAS. (See the listing of resources at the end of the teacher materials for this activity.)

FROM THE SUN TO YOU

OBJECTIVES

The students will do the following:

1. Trace the flow of solar energy.
2. Recognize the relationship between the sun and the food chain.

SUBJECTS:

Science, Health

TIME:

50-100 minutes

MATERIALS:

crayons or markers, student sheet (included)

BACKGROUND INFORMATION

Energy from the sun is the basis for life on earth. Green plants must have the sun's energy in order to make sugars and other substances from carbon dioxide and water. The energy stored in the plants is then passed on to animals that eat the plants and is passed on up the food chain as more "eaters"—consumers—participate in the food chain. The basis of every food chain is a green plant, and the sun provides the energy the plant must have.

Terms

food chain: a path by which energy and materials pass from one living thing to another in the form of food.

solar energy: the energy (heat and light) received from the sun.

PROCEDURE

I. Setting the stage

A. Ask the students the following questions:

1. How many of you have eaten a hamburger before?
2. From where does the hamburger meat come?
3. What do cattle eat to keep alive and produce hamburger meat? (hay, grass)
4. What makes hay and grass grow? (sun, water, soil)

B. Define for the students the terms solar energy and food chain.

C. Share the background information with the students.

II. Activity

- A. Give each student a copy of the student sheet "FOOD CHAIN," included. Discuss the illustrated food chain with them. Stress that the food chain begins with the sun and ends with the students.
 1. Let the students color the student sheet (if desired).
 2. Divide the students into small groups. Let each group select a food the members like to eat and draw a food chain showing their consumption of that food. They may choose any meat, fruit, vegetable, grain, or dairy product. (Guide their choices so that their selected foods are not too complicated; a simple food should probably be chosen.)
- B. Have the students write a short paragraph explaining how each food chain step is related to the sun.
- C. Ask the students to think about things they use at school each day (such as pencils, paper, or books). Have them trace the objects' origins back to the sun.

III. Follow-up

- A. Have the students define the terms solar energy and food chain.
- B. Ask the students in each group to explain their food chain picture. Ask what food they chose and where we get this food. How does this animal or plant grow?

IV. Extension

- A. Have the students investigate further the sun's importance to life on earth.
 1. Have some students design a bookmark explaining how it (the bookmark) originated from the sun.
 2. Have the students write advertisements beginning "Help Wanted: Need the Sun." Limit the number of words so that the ads sound real. These may be collected and made into a "Help Wanted" page.
 3. Some students may make collages of magazine pictures showing things we get from the sun.
- B. As a writing assignment, some students may write a fairy tale about an evil being who takes away the sun one summer.

RESOURCES

Mallinson, G. G., et. al. The Silver Burdett Elementary Science Program (pupils' books and teachers' editions, levels K - 6). Morristown, NJ: Silver Burdett, 1984.

McDonald's Corporation. Ecology and Energy Action Pack. Oak Brook, IL: Author, 1977. (Address: Director - Corporate Responsibility, McDonald's Corporation, One McDonald Plaza, Oak Brook, IL 60521.)

FOOD CHAIN

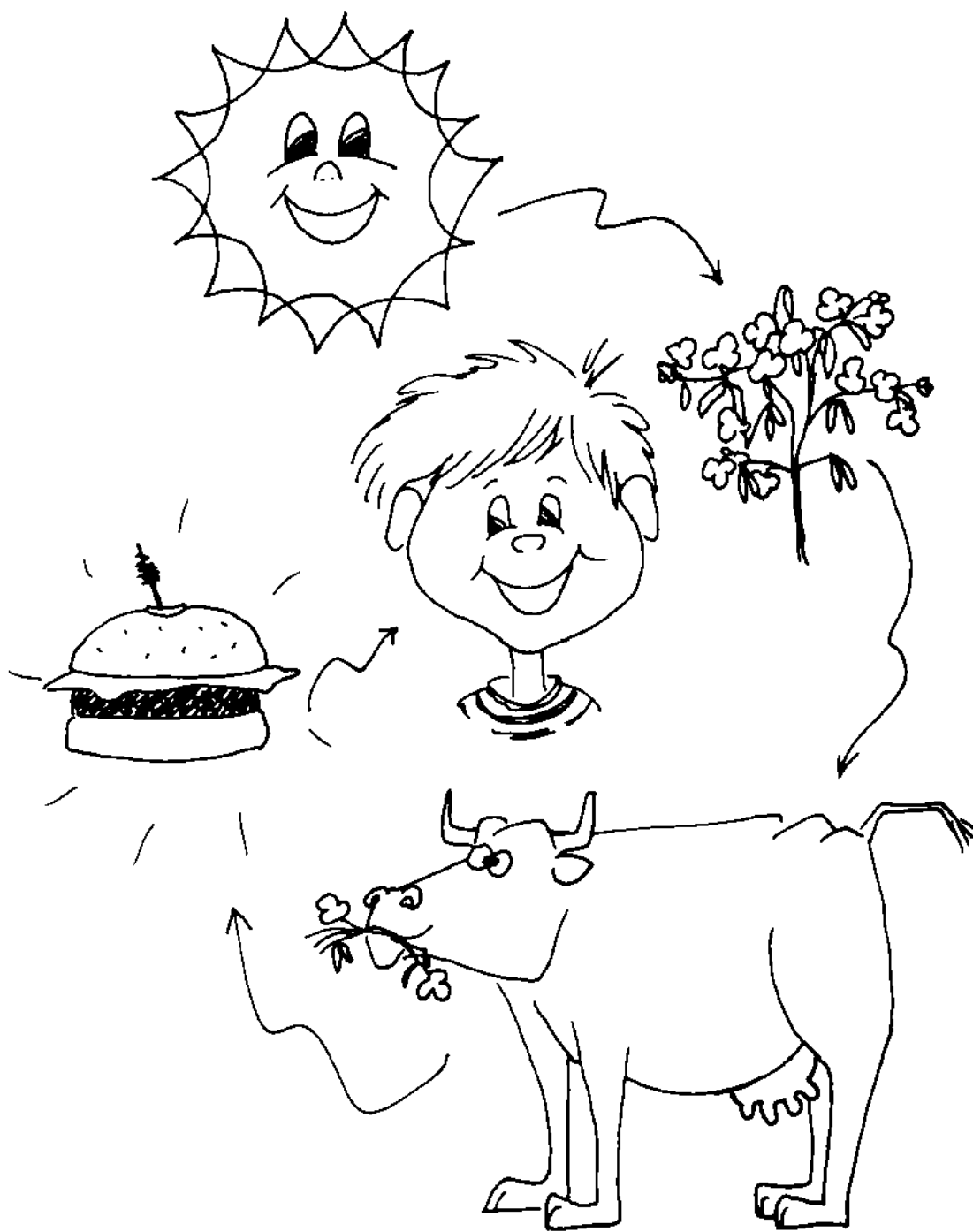

SOLAR SIZZLING!

OBJECTIVES

The student will do the following:

1. Construct and use a simple solar cooker.
2. Learn practical uses of the sun's energy.
3. Learn the advantages and disadvantages of solar cooking.

SUBJECT:

Science

TIME:

50-100 minutes

MATERIALS:

heavy cardboard box, black construction paper (or flat black paint), tape, scissors, plastic wrap, small unwaxed paper cups, larger cups, apple slices, aluminum foil, newspaper, student sheets (included)

BACKGROUND INFORMATION

Exploring alternative sources of energy becomes more important as our other energy resources dwindle. The sun is the cleanest source of energy. Its light and heat are free as well as unlimited in supply. Of course, its availability varies from day to day and from place to place. It is also a diffuse energy source (unlike fuels, which are highly concentrated).

Nevertheless, there are numerous ways to use this energy source. One use of solar energy is for cooking. Solar cooking is somewhat limited in that it can best be used only at mid-day and in fair weather; however, solar cooking is relatively simple and is important in some places in the world (especially where firewood is in short supply).

Some day we may need the sun to provide most of our energy, so it is important to learn ways to harness this valuable resource. Solar cooking is but one avenue to be explored.

PROCEDURE

I. Setting the stage

A. Have the students think about the sun's importance.

1. Read the following passage to the students:

"Some say the sun is a golden earring, the earring of a beautiful girl. A white bird took it from her when she walked in the fields one day. But it caught on a spider web that stretches between the homes of men and the homes of the gods." (from India)

2. Ask the students if they think this is a good description of the sun and why it is in the sky. Discuss why such stories were told. (to explain things in nature that people did not understand)

B. Ask the students the following questions:

1. What kinds of energy do we get from the sun? (heat and light)
2. What kind of energy is used for cooking? (heat) Ask them if they think the sun can be used for cooking. Why or why not? List their responses on the board.
3. Have they ever heard someone say that it is "hot enough to fry an egg on the sidewalk?" Discuss the saying, then share appropriate parts of the background information with the class.

II. Activity

A. Tell the students that they will build a simple cooker to prove that we can use the sun's energy to cook food.

1. Let the students assist you in building the solar cooker(s), or build it ahead of time and explain how it was built. Use the following directions:
 - a. Get a heavy corrugated carton from the grocery store.
 - b. Fold in the open flaps and tape them down.
 - c. Line the inside with black construction paper, or paint it flat black.
 - d. The best foods to cook are simple ones. You might put hot dogs in an aluminum pan, fill a baking dish with baked beans, or (in summer) put cookie dough on a cookie sheet.
 - e. When you are ready to cook, put the dish of food inside the solar cooker and cover the box with a double layer of plastic wrap. Tape it down lightly.
 - f. The cooker is to be placed outside in full sun. It may be flat on the ground or slightly tilted toward the south. It will receive the most sunshine from 11:00 a.m. to 2:00 p.m.; try to plan accordingly.
 - g. Allow about 1-1/2 to 2 hours for the food to cook.
2. The next day, have a solar picnic. Cook some hot dogs in the solar cooker. Make "sun tea" also.
 - a. Have the students record the cooking time, the time of day, weather conditions, and the date for later discussion.
 - b. Discuss with the students how the cooker might be improved.

B. Use the sun's energy to bake apple slices.

1. Prepare the materials for the students to construct their apple bakers. Spray painting the insides of the small cups flat black would simplify the assembly, as would obtaining sheets of foil-and-paper sandwich wrap (like that used by fast-food restaurants).

2. Distribute copies of the student sheet "APPLE BAKER," included. Make the "sun collector" first; the baker is assembled outside. Choose a sunny day to cook the apples, and distribute to each student the materials he/she needs (including an apple slice).
3. While the apple slices are baking, discuss the advantages and disadvantages of solar cooking with the students.

III. Follow-up

- A. Have the students do the word search puzzle on the student sheet "SOLAR COOKING WORDS," included.

| | | | | | | | | | | | | | |
|---|---|---|---|---|---|---|---|---|---|---|---|---|---|
| S | O | L | A | R | C | O | O | K | E | R | W | I | Q |
| C | R | P | W | K | V | O | R | U | O | S | Z | I | N |
| A | K | A | D | N | H | E | A | T | H | C | G | T | |
| E | T | J | I | O | O | M | E | T | U | A | C | H | Q |
| H | L | W | A | F | I | R | E | Z | W | O | T | N | |
| T | G | H | R | V | L | T | N | Y | O | E | A | K | J |
| I | O | S | U | N | C | A | E | C | K | J | L | V | E |
| S | Z | N | R | W | P | O | R | T | C | L | E | A | N |
| T | E | K | T | F | R | E | E | N | E | R | G | Y | |

- B. Have the students answer the questions and draw a picture of the solar cooker on the student sheet "COOKING WITH THE SUN," included.

IV. Extension

Choose activities from the following:

- A. Have the students conduct library research to find other recipes for solar-cooked foods. The recipes can be made into a solar cookbook, which may be shared with other classes or with the students' families.
- B. Have some students make acrostics using words about solar cooking. Posters could be made and hung in the classroom.
- C. Some students may write and illustrate limericks (funny five-line poems with the rhyme scheme aabba) that say something about the sun's energy and/or solar cooking.
- D. Interested students may plan menus using solar-cooked foods. The menus should include foods from all food groups. Posters showing these meals could be prepared for display.
- E. Some students may make their own word searches using the student sheet "HIDDEN WORD SEARCH" (included) and the given words (sun, solar cooker, scientist, free energy, clean, fire, light, heat, shade). The students can exchange papers and solve each others' puzzles. Sentences using each word in the puzzle should be written when the puzzles are solved.

RESOURCES

Belting, N. M. The Sun is a Golden Earring. New York: Holt, Rinehart, and Winston, 1962. (pp. 2-5)

Bonestell, C. The Solar System. N.p: Childrens Press, 1981. (p. 22)

"Building A Solar Oven." Organic Gardening, August 1980.

Butti, K. and J. Perlin. A Golden Thread: 2500 Years of Solar Architecture and Technology. New York: Van Nostrand Reinhold, 1980.

Halacy, B. and D. Halacy. The Solar Cookery Book. Lakewood, CO: N.p., 1978.

Jackson, H. C. and I.L. Follman. Light, Universe, Plants, Energy. St. Louis, MO: Milliken, 1979. (p. 23)

Kaplan, S. Solar Energy. Milwaukee, WI: Raintree Publishers, 1983. (pp. 39-43)

Natural Sciences Industries. "Solar Oven Lab" (pamphlet). Far Rockaway, NY: Author, 1976.

Oak Ridge Associated Universities (assisted by Lawrence Hall of Science). "Solar Energy" (pamphlet). N.p.: Author, 1977.

APPLE BAKER

Materials: small (unwaxed) paper cup, black paper (or spray paint), tape, white paper, aluminum foil, plastic food wrap, scissors, newspaper, large cup, apple slice

1. Line the inside of a paper cup with black paper (or spray paint beforehand). Put a slice of apple in the cup. Cover the cup tightly with plastic wrap.

2. Make a large cone from white paper. Line the cone with aluminum foil. Put the apple cup down inside the cone.

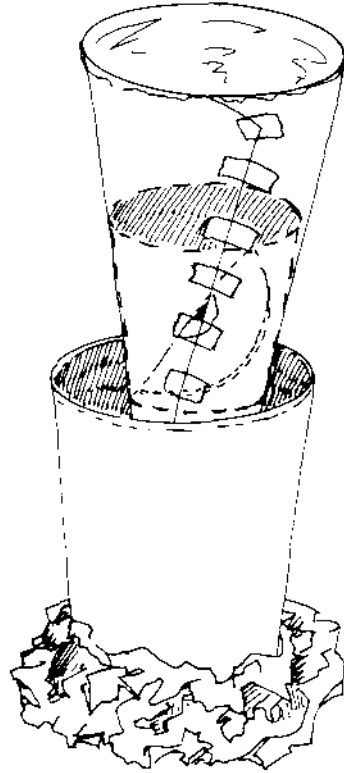

3. Put the cone down inside a bigger cup. Crumple newspaper around the bottom of the outside cup.
4. Set up your apple baker outside in full sun. Aim the cone at the sun. Write down the time you start cooking. (Check on the apple slice every 10 minutes or so.) When the apple looks cooked, check the time again. How long did it take? _____ minutes
5. How does the apple slice look? How has it changed? _____

6. You probably won't want to eat the apple slice, but birds and other animals might! Leave it outdoors for them, and dispose of the apple baker as your teacher instructs you.

SOLAR COOKING WORDS

Find the following terms hidden in the puzzle. Circle each term. Then write a sentence about solar cooking or solar energy using each of the words.

SUN
SOLAR COOKER
SCIENTIST

FREE ENERGY
CLEAN
SHADE

LIGHT
HEAT
FIRE

S O L A R C O O K E R W L Q
C R P W K V O R U O S Z I N
I A K A D N H E A T H C G T
E T J I O O M E T U A C H Q
N L W A F I R E Z W D O T N
T G H R V L T N Y O E A K J
I O S U N C A E C K J L V E
S Z N R W P O R T C L E A N
T E K T F R E E E N E R G Y

COOKING WITH THE SUN

1. Describe one advantage and one disadvantage of solar cooking.

Advantage: _____

Disadvantage: _____

2. Draw a picture of the solar cooker that we used and show where the box should be placed for the best results.

HIDDEN WORD SEARCH

Make your own hidden word search using these words—sun, solar cooker, scientist, free energy, clean, fire, light, heat, and shade. When the puzzle is solved, write sentences using each word.

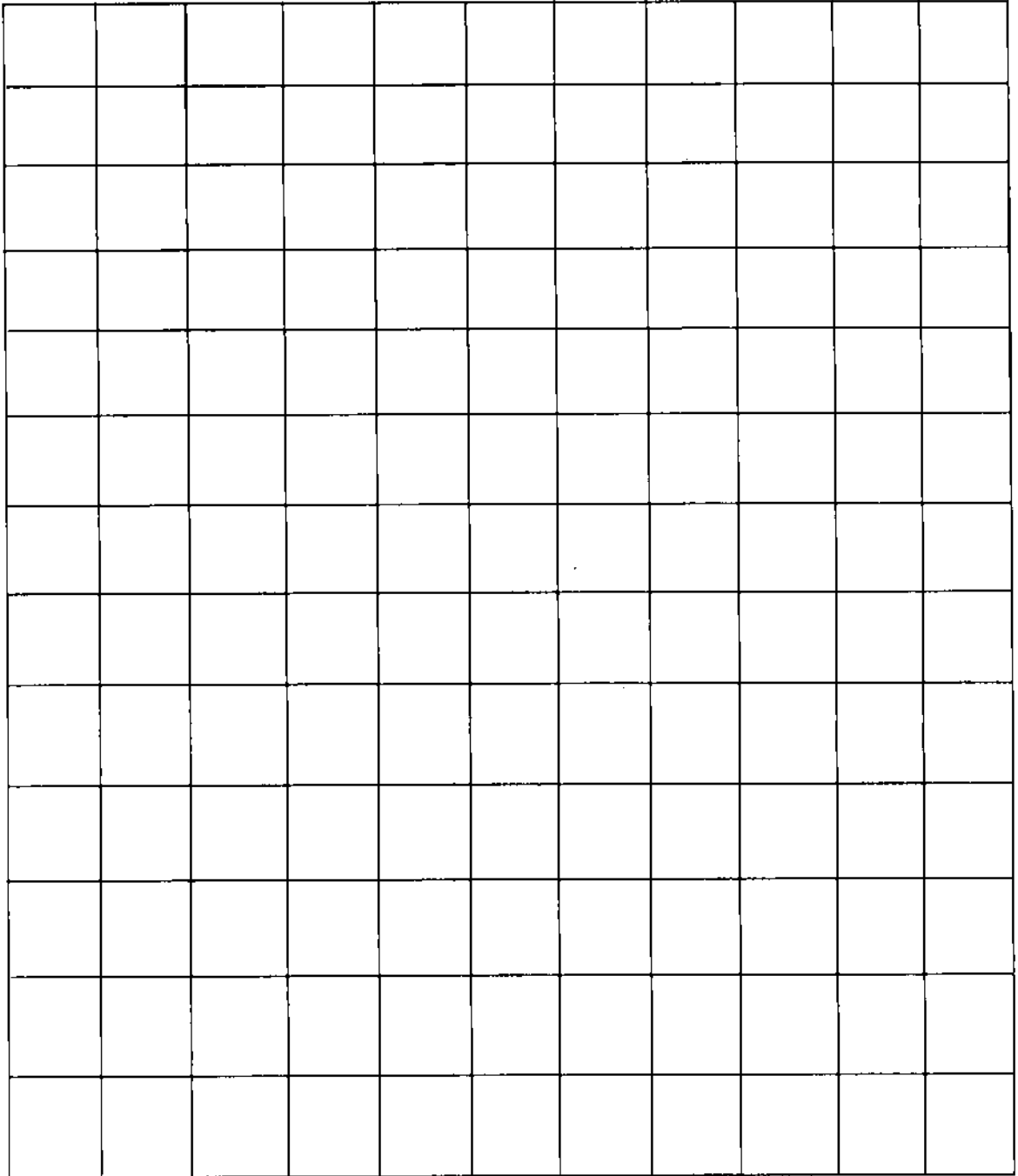

SOLAR GREENHOUSES

OBJECTIVES

The student will do the following:

1. Explain the advantages of solar greenhouses.
2. Explain the importance of the three major components of solar greenhouses—glazing, heat storage materials, and insulation.
3. Build a solar greenhouse model.
4. Compare the effect of different colors on solar heat absorption.
5. Compare the effect of different materials on solar heat storage.

SUBJECT:

Science

TIME:

220 minutes

MATERIALS:

(for each group) cardboard box, 2 coffee cans, spray paint (various colors including black and white), razor knife, tape, plastic wrap, thermometer, compass, wood chips, rocks, teacher sheet (included)

BACKGROUND INFORMATION

Solar greenhouse development started in Canada in the early 1970s. Solar greenhouses are designed to maximize the usefulness of solar energy. There are thousands of solar greenhouses in the United States. Some of the advantages that may be enjoyed because of solar greenhouses are fresh fruits and vegetables year-round, foods free from chemicals, and new hobby opportunities. Another important advantage of solar greenhouses is that they can be attached to houses, providing substantial heat, a warm, bright room, and humidity to make the houses more comfortable.

A solar greenhouse must have glazing, heat storage materials, and insulation. The glazing in a solar greenhouse is the transparent or translucent window-like material that allows sunlight to enter and keeps heat from escaping. Most of the glazing is on the south side of the greenhouse where it will collect more energy during the day than it loses at night. Double glazing reduces heat loss day and night. Materials that can be used for glazing include glass, acrylics, and fiberglass.

Heat storage material in the greenhouse absorbs solar energy in the daytime and then releases the stored heat at night when the greenhouse cools off. Cement, earth, bricks, stone, or large containers of water may be used as storage materials. Very dark colors are used because they absorb heat best. If heat storage materials were not used, the air temperature could get up to 140 degrees (F) on a very hot, sunny day, and the night temperatures could get quite cold. This is, of course, not comfortable or desirable for people or plants. Massive heat storage materials tend to stabilize the temperature, improving both the comfort of the greenhouse for people and the productivity of plants.

Insulation is another key factor in the efficiency of solar greenhouses. They should be well-insulated to prevent as much heat loss as possible.

Terms

glazing: glass or other transparent material (such as is used for windows) used to trap solar energy in a solar device or building.

heat storage materials: materials such as concrete, rocks, or water, that are capable of absorbing heat energy and slowly releasing it as the atmosphere cools down.

insulation: material that hinders the flow of heat energy.

PROCEDURE

I. Setting the stage

A. Ask the students the following questions:

1. What forms of energy do we get from the sun? (heat and light)
2. What do plants need to grow? (heat, light energy, water, nutrients from the soil) Lead the students to deduce that plants need sunlight to grow.
3. Why don't we have gardens in the winter? (the weather is too cold)
4. How could we have gardens all year? (Lead the students to answer "greenhouse.") Explain to the students that some greenhouses use special light and heating to produce plants year-round.

B. Share the background information with the students, showing them a transparency made from the provided teacher sheet "SOLAR GREENHOUSE."

1. Discuss the advantages of solar greenhouses.
2. Explain the importance of glazing, heat storage materials, and insulation in the workings of a solar greenhouse.
3. Explain that dark colors absorb more heat energy than light colors.
4. Relate insulation to the way we insulate our bodies. Ask the students why we wear coats, hats, gloves, and so on in the winter. Hold up several articles of clothing (for example a T-shirt, a windbreaker, gloves, sandals, and a hat). Ask the students which they would wear if they were going to an outdoor ballgame when there is chance of snow. Ask the students why they would wear those items. (Lead the students to answer that they trap and store body heat.) Explain that the same principle applies to a solar greenhouse; it needs to be well-insulated to prevent heat loss.

II. Activity

A. The day before the activities are to be done, ask the students to wear variously colored shirts (red, white, blue, yellow, black, brown, and dark green).

1. Take the class outside. You will need several compasses. Review briefly the information about the solar greenhouse.

2. As you stand outside in the sunshine, ask the students the following questions:
 - a. Which one of you is absorbing more heat? Why? Who is absorbing less heat? Why?
 - b. Ask the students to explain their different heat absorptions in terms of the colors of their shirts.
3. Take the students to your car. Ask the students, "If my car was a solar greenhouse, what direction would I want it to face?" (south)
 - a. Have the students identify the instrument used to find geographical directions. (compass)
 - b. Distribute several compasses. Have the students find south.
 - c. Ask the students what would be the glazing if your car was a greenhouse. (the windows)
 - d. Let some of the students take turns sitting in the car to feel the stored heat.

B. Have the students do the following activity to show that dark colors absorb more heat.

1. Divide the students into groups of four.
2. Have each group bring to class a cardboard box, two coffee cans, any color spray paint, and plastic wrap. Provide tape and a thermometer for each group.
3. Have the students build and use a model greenhouse as instructed below.
 - a. A window should be cut out of the front of the box using a razor knife. CAUTION—SUPERVISE CAREFULLY!
 - b. Have the students spray paint their cans. For example, group #1 may have two black cans; group #2, white cans; and so on.
 - c. Have each group cover the front of its box with a double layer of plastic wrap, taping it securely across the top of the box. (Leave the bottom and sides of the plastic free.)
 - d. Take the students outside, and give each group a compass so that the students may determine how to face their model solar greenhouses toward the south.
 - e. Return to the classroom and have each group make a chart that looks like this:

| Time | Temperature |
|------------|-------------|
| 8:00 a.m. | |
| 11:00 a.m. | |
| 2:30 p.m. | |

- f. At the beginning of the following day, have each group take its model greenhouse, water-filled cans, tape, a thermometer, the data chart, and a pencil to the experiment location previously chosen.

- g. Have each group measure the temperature of the water and record it on the data chart.
 - h. Have each group place the cans of water in the model greenhouse, and securely tape the free edges of the plastic to the box.
 - i. Have each group measure the water's temperature again at 11:00 a.m. and 2:30 p.m. (When they remeasure, the tape will have to be pulled away. Remind the students to retape securely, so that the greenhouse will not lose heat.)
4. Back in the classroom, compile the charts for each group's temperature readings. Put the compiled chart on the board or make a transparency. The compiled chart should look something like this:

| | Black | Brown | Dk. Green | White | Yellow | Blue |
|------------|-------|-------|-----------|-------|--------|------|
| 8:00 a.m. | | | | | | |
| 11:00 a.m. | | | | | | |
| 2:30 a.m. | | | | | | |

5. Discuss the findings with the students. Ask the students what colors seemed to absorb more heat, why they think this is so, what colors absorbed less heat, and why they think this is so.
 6. If some data show the light colors absorbing more heat, ask what could have gone wrong. (glazing was not secure, box had a hole in it [poor insulation], they read the thermometer incorrectly, and so on)
- C. Have the students modify the experiment to investigate heat storage.

1. Have the students test the heat storage capabilities of different materials using the solar greenhouse model in B. above.
 - a. Provide three black and one white spray-painted cartons, coffee cans, or other containers—one per group. The first group should obtain a black container of rocks; the second, a black container of wood chips; the third, a black container of water; the fourth, a white container of water.
 - b. Have the students follow the directions given II.B.
2. Back in the classroom, compile the charts for the temperatures of the different types of storage materials. Put the compiled chart on the board or on a transparency so the entire class may see it. The compiled chart should look something like this:

| | Container with rocks | Container with wood chips | Black container with water | White container with water |
|------------|----------------------|---------------------------|----------------------------|----------------------------|
| 8:00 a.m. | | | | |
| 11:00 a.m. | | | | |
| 2:30 a.m. | | | | |

3. Have the class discuss which material stored the most energy.

4. Ask the students the following questions:
 - a. What heat storage materials would you use if you were building a solar greenhouse? Why?
 - b. What would you not use? Why not?
 - c. What would be the most practical? Why do you think so?

III. Follow-up

A. Ask the students the following questions:

1. What colors absorb the most heat? (dark colors)
2. What colors absorb the least heat? (light colors)
3. How can we relate this to solar greenhouses? (They need dark-colored storage containers to absorb more heat.)
4. Why do solar greenhouses need heat storage containers? (to absorb the solar energy in the daytime to keep the greenhouse from getting too hot and to release the heat at night to keep the greenhouse from getting too cool)
5. What would happen in a solar greenhouse that did not have any heat storage containers? (It would get too hot in the daytime and too cool at night. The plants would be harmed and it would be uncomfortable for people.)
6. In the model solar greenhouse that you made, what material did you use for glazing? (plastic) What are some materials that real solar greenhouses use for glazing? (glass, acrylics, and fiberglass) What is the purpose of glazing? (It allows the sunlight to enter and keeps the heat from escaping.)
7. Which direction does the front—the glazing—need to face? (south) Why? (to get the most direct sunlight)
8. How do we insulate our bodies? (by wearing coats, gloves, hats, shoes, and so on) Why do we wear these things? (to trap our body heat so we can stay warm)
9. Why does a solar greenhouse need insulation? (to keep it from losing heat energy at night or in cold weather)
10. Summarize the findings of the experiments.

B. Discuss with the students the following items:

1. Have the students suggest some ideas for building efficient solar greenhouses. (Ideas should be drawn from the class's solar greenhouse discussion and experiments. Accept reasonable answers. They should include the fact that the greenhouse should face south and should have glazing, heat storage materials, and insulation.)
2. Have the students list the advantages of solar greenhouses.
3. Have the students compare and contrast the different types of heat storage materials used in the experiment.

IV. Extension

Choose from the following activities:

- A. Some students may draw murals or make collages of some types of plants that might be found in a solar greenhouse.
- B. Have the students write a newspaper advertisement for a greenhouse plant sale.
- C. Have the students write poems about greenhouses. Brainstorm together with the students for words that rhyme with house.

RESOURCES

Alabama Solar Energy Center. Building and Using the Solar Greenhouse. Huntsville, AL: Author, July 1984. (Address: The University of Alabama in Huntsville, Research Institute, Box 212, Huntsville, AL 35889.)

Fisher, R. and B. Yanda. The Food and Heat Producing Greenhouse - Design, Construction, and Operation. N.p: N.p, 1976.

National Appropriate Technology Assistance Service. Build a Solar Greenhouse. Butte, MT: Author, July 1980. (Address: NATAS, P.O. Box 2525, Butte, MT 59702-2525. Telephone: 1-800-428-2525.)

SOLAR GREENHOUSE

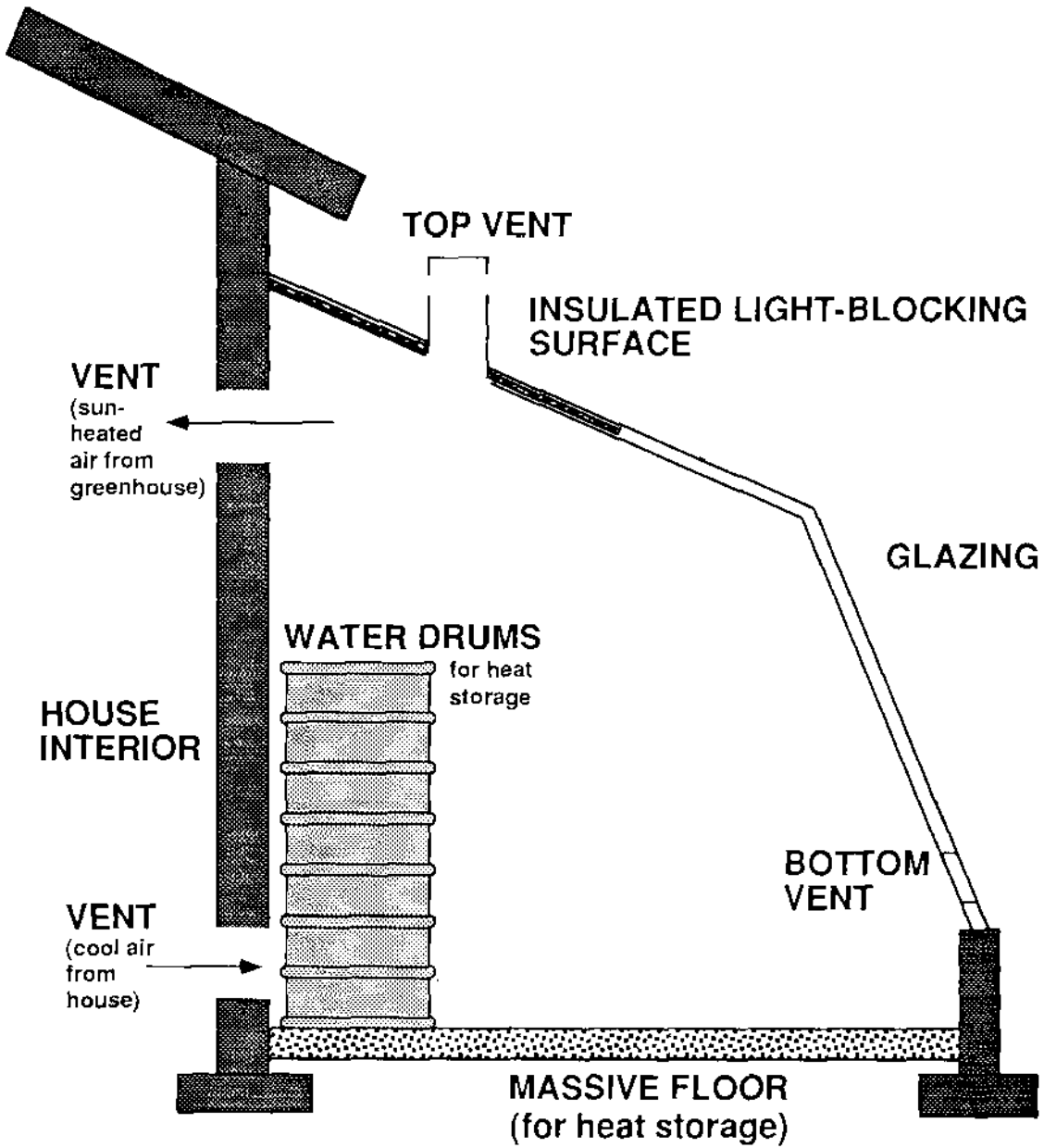

BE "SUN"-SIBLE ABOUT HEATING WATER

OBJECTIVES

The student will do the following:

1. Construct a simple solar water heater.
2. Investigate color and heat.
3. Investigate insulation and heat.

SUBJECT:

Science, Math

TIME:

120 minutes

MATERIALS:

juice cans, paint (white, black, green, red), very hot water, food colors, ice cubes, thermometers, construction paper (white, black, green, red, blue), watch, quart jars, cardboard boxes, newspaper, glue or rubber cement, aluminum foil, razor knife, clear plastic wrap, dowel, duct tape, tape, 1-qt. can, flat black spray paint, student sheets (included)

BACKGROUND INFORMATION

Heating water for use in the home is a major contributor to the home energy bill. One way to reduce energy use by the heater is to turn its thermostat back; settings of 120 to 140 degrees will save energy and still provide water hot enough for all the various purposes for which it is used. Another way to reduce energy consumption by the home water heater is to use less hot water. Cold or warm water performs satisfactorily for typical laundry loads. One can take shorter showers or shallower baths. Repairing dripping hot water faucets can save a surprising amount of hot water.

Using the sun's energy is another way to reduce the hot water energy bill. The sun's energy is free, so the cost of solar heated water is less than that of conventionally heated water. Home solar water heaters usually consist of a solar collector, pipes through which water circulates from the collector to the water heater, and a highly efficient water heater similar to a conventional one. The collector, often mounted on the roof, is a dark-colored, glass-faced box in which the sun's heat is trapped. This trapped energy heats the water being pumped through the system's pipes, which pass through the collector. The heated water returns to the water heater, where it is perhaps heated further and is stored for use. The entire system is well-insulated, so as to avoid losing heat. Solar water heaters can help lower the high cost of heating water.

Terms

insulation: material that hinders the flow of heat energy.

solar collector: any device used to trap the sun's energy and change it into heat energy.

PROCEDURE

I. Setting the stage

- A. Have the students consider the energy used to heat water for home use. Give each student a copy of the student sheet "JONES FAMILY ELECTRICITY USE," included. Have the students examine the graph, and discuss with them the questions on the sheet.
- B. Share with the class the related information from the background information furnished.

II. Activity

A. Have the students investigate color and heat.

1. Have the students do the activity on the student sheet "WHICH COLOR HOLDS HEAT LONGEST?," included.
 - a. Help the students make graphs and record data as they follow the instructions on the student sheet.
 - b. Discuss the results with the students.
2. Have the students investigate color and the time required for ice to melt. (Do this yourself as a demonstration or have groups of students do it.)
 - a. Have squares of construction paper in the following colors—white, black, green, red, and blue. Place an ice cube on each square of colored paper.
 - b. Time how long it takes for each ice cube to melt.
 - c. Discuss with the students the results of the investigation.

B. Have the students investigate insulation and solar water heating.

1. Divide the students into groups of three or four each. Give each group a copy of the student sheet "INSULATION REALLY WORKS" (included), and have the groups complete the activity as instructed.
2. Review the definition of the term "insulation" and relate it to water heating and storage.

C. Have the students build model solar water heaters.

1. Divide the students into groups of three or four each.
2. Distribute the student sheet "HOW TO MAKE A SOLAR WATER HEATER MODEL" (included) to each group and provide the materials they need.
3. Have them build the model solar water heater models according to the instructions on the sheet.
4. Have the students experiment with different colors or kinds of containers for the water.

III. Follow-up

A. Ask the students the following questions:

1. What are some ways energy is used in the home? (heating, water, air conditioning, appliances, and so on.)
2. What are some ways to reduce the amount of energy used to heat water? (turn water heater thermostat down; use less hot water; repair dripping hot water faucets)

B. Have the students complete the following:

1. Define solar energy.
2. Define insulation.
3. Describe how a solar water heater model works.

C. Ask the students the following questions:

1. How can we use the sun's energy to heat our homes and water? (Heat from the sun can be gathered by solar collectors and stored until needed.)
2. Which reach a higher temperature more quickly when placed in direct sunlight—light-colored or dark-colored objects? (dark)
3. How does a solar collector work? (A solar collector is a box-like device with a glass [or similar material] face and a black interior. It traps and absorbs the energy of the sun's rays. Water piped through the collector is heated and sent to a storage device.)

IV. Extension

- A. Have interested students make posters or a bulletin board of warm and cool fabrics.
- B. Have the students write to the U.S. Department of Energy's Assistant Secretary for Conservation and Renewable Energy for further information on solar energy (Address: 1000 Independence Avenue, SW, Washington, DC 20585) .
- C. Invite someone to speak to the class about solar energy.

RESOURCES

Alabama Solar Energy Center. "Energy Factsheet/Solar Water Heaters." Huntsville, AL: Author, n.d.

_____. "Solar Homes for Alabama." Huntsville, AL: Author, n.d. (p.2-3)

Barufaldi, J. P., G. T. Ladd, and A. J. Moses. Heath Science, Levels 3-5. Lexington, MA: Heath, 1984.

National Appropriate Technology Assistance Service. "How to Make a Solar Water Heater." Connections. A Curriculum in Appropriate Technology for 5th and 6th Grades. N.p.: U.S. Department of Energy, 1986. (Address: NATAS, P.O. Box 2525, Butte, MT 59702-2525. Telephone: 1-800-428-2525.)

Tennessee Valley Authority. "Seasonal Sun and Home Orientation." (Adapted from Solar Home, Brick House Publishing Company.) N.p.: Author, 1981. (Out of print.)

U.S. Department of Energy. Energy Use in Homes and Stores: Your Energy World, Unit Three. Washington, D.C.: Author, February 1978.

JONES FAMILY ELECTRICITY USE

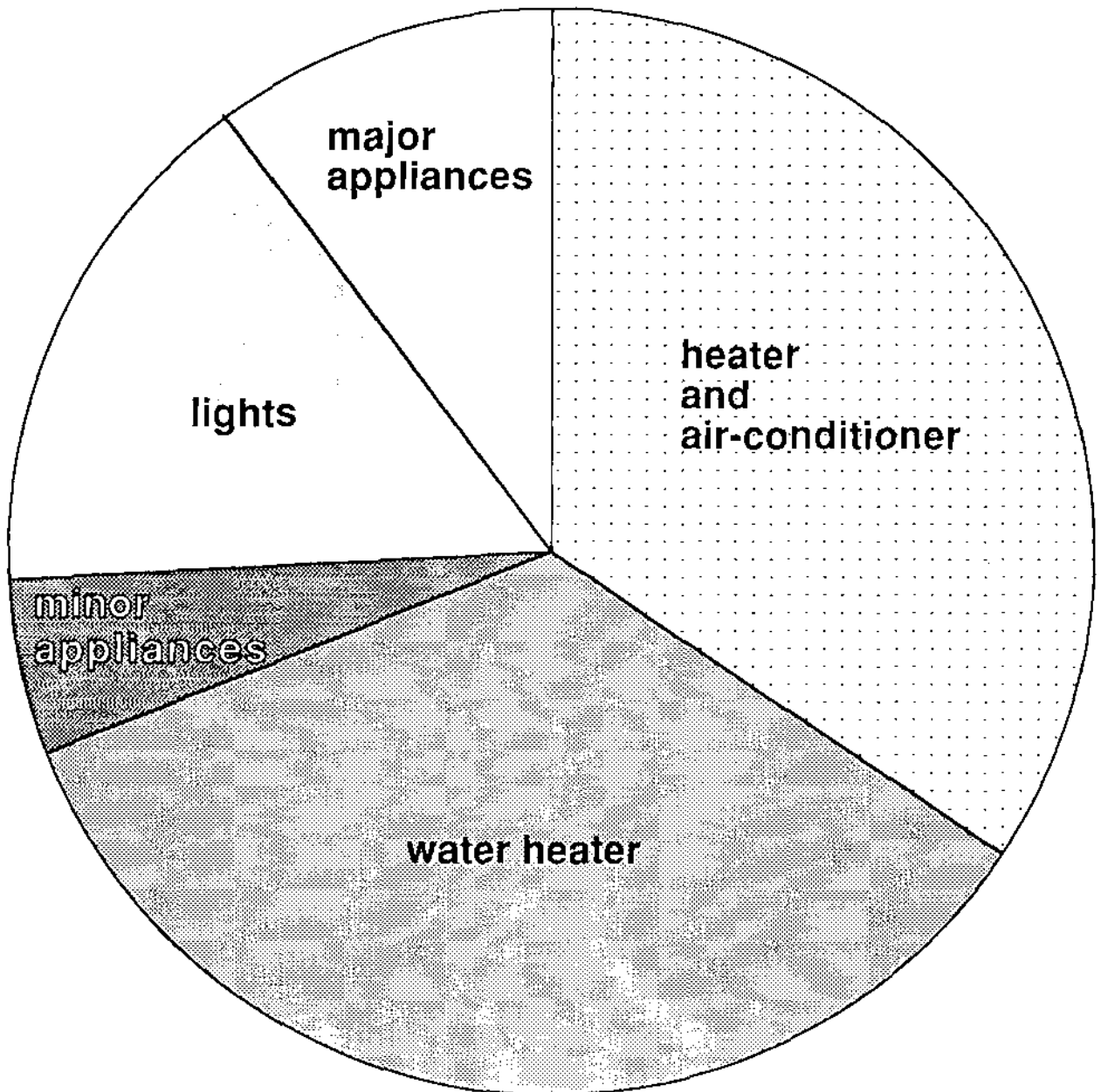

The Jones family made a circle graph to study electricity usage at their house. The graph shows that a large portion of their bill is for heating water.

What are some ways the Jones family could decrease their electric bill?

Is there an alternative method for heating water?

WHICH COLOR HOLDS HEAT LONGEST?

Materials: 4 juice cans, 4 colors of paint (white, black, green, and red), very hot water (close to boiling), 4 thermometers, food colors.

1. Paint each can a different color.
2. Fill each can with the same amount of hot water.
3. Add food coloring to the hot water; add drops of all the colors together to get black.
4. Put a thermometer in each can.
5. Read and record the temperature every three minutes until the water cools.
6. Make a graph of the results.

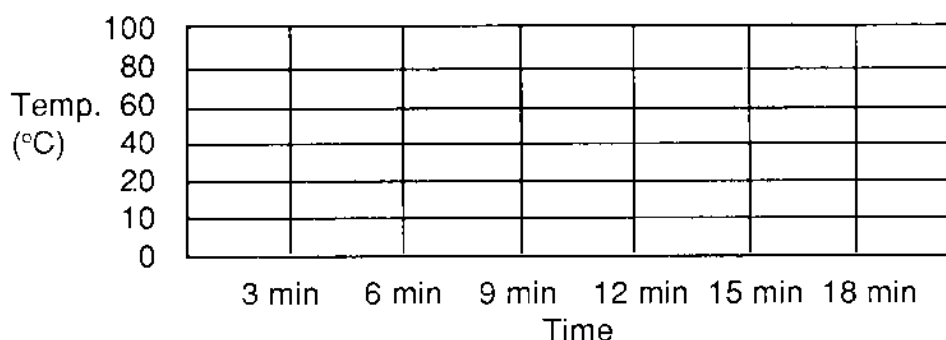
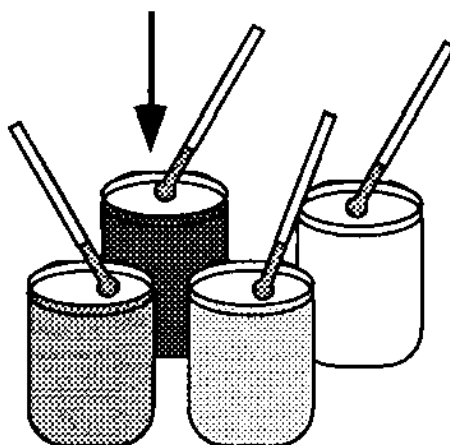

Which color held heat best? _____

INSULATION REALLY WORKS

Fill two quart jars with hot tap water and put a thermometer in each jar to measure the temperature of the water.



Record the starting temperature on the chart below. Next, place one of the jars in a cardboard box. Cover it and surround it with shredded newspapers. The other jar remains as is.

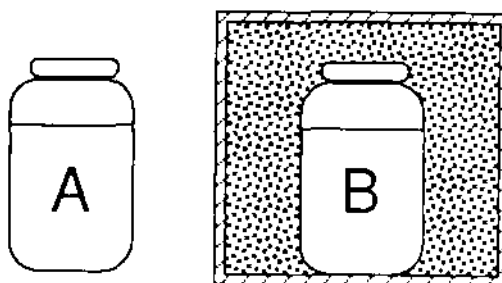

After one of the jars is “insulated,” read and record the temperature of each jar every 10 minutes. After 30 minutes have passed, compare the results.

| | Jar A | Jar B |
|----------------------|-------|-------|
| Starting temperature | | |
| After 10 minutes | | |
| After 20 minutes | | |
| After 30 minutes | | |

HOW TO MAKE A SOLAR WATER HEATER MODEL

1. Cut a cardboard box in half diagonally.

Cut the box in half along the diagonal as shown, leaving a triangularly shaped top and bottom. Then cut off the top triangle. The left-over piece has two sides that can be cut out to fit flat onto the sides of the remaining box. Then tape them to the sides of the half-box. These side pieces will add some thickness to the walls and help keep heat inside. Glue aluminum foil to the inside of the box (sides and bottom) with rubber cement (be sure to read the directions on the label).

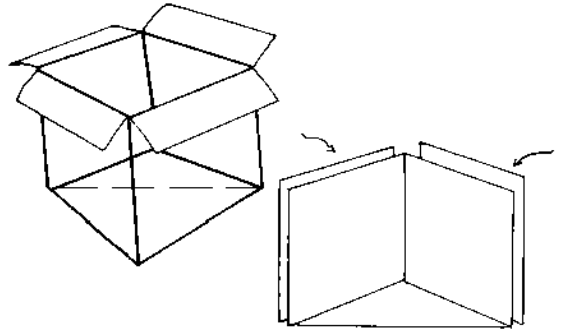

2. Glazing the box.

Tape a small stick of wood (a dowel) across the top corners of the heater box as a brace. Use silver duct tape. Tape clear plastic wrap to the bottom and sides of the box as shown. Make sure it is long enough to have some left over to fold over the top. The fold-over flap can be used as a door to get into the box. You can tape heavy weights to the corners for holding it shut or you can tape the corners down.

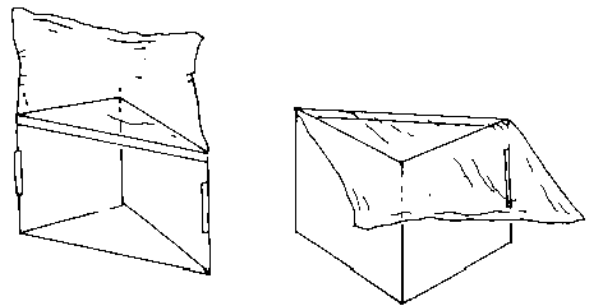

3. Prepare the water can.

Use any can that is one quart in size and has no leaks. Spray paint it with flat black paint.

4. Set up the water heater.

Open the top of the heater box. Fill the water can, cover the top of it with clear plastic wrap and put a rubber band around the top of the can to seal it. Place the filled can on the bottom of the heater box and close the top flap. Be sure it is well-sealed. Face the front of the box to the south and wait for it to heat up. You can test the temperature of the water by sticking a thermometer into it. You can also experiment with different colors or different kinds of cans and jars.

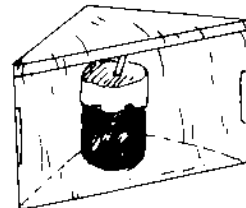

THEN AND NOW

OBJECTIVES

The student will do the following:

1. Identify the three major fuel eras—wood, coal, oil—in order of their place in history.
2. Compare the three major fuel eras in energy history.
3. Examine energy use today.

SUBJECTS:

Science, Social Studies, Art

TIME:

100 minutes

MATERIALS:

shoe boxes, pictures of inventions, scissors, glue, assorted craft materials (for building floats), crayons or markers, student sheets (included)

BACKGROUND INFORMATION

Throughout human history, the development of new energy sources has been linked to human progress. Fire and bodily strength were all that primitive people had to use. Harnessing new sources of energy and building new machines to use them has changed our lifestyles dramatically. The study of our energy past reveals three major energy time periods—the wood era, the coal era, and the oil era.

Before 1885, wood was the most important energy source (although wind and water were also used). Extensive forests provided easy-to-get and inexpensive wood. It was used for light, warmth, cooking, and heating water. Trains and steamboats used wood for fuel, and blacksmiths burned it for heat needed to make horseshoes and tools. By the 1860's, wood was not as plentiful near the cities where so much of it was needed. It became more expensive because it had to be transported greater distances.

Around 1885, city dwellers and manufacturers began to use coal because wood was more difficult to get and more expensive. Coal was used as fuel for steamboats, trains, and home furnaces. It was used in the steel industry and, later, in the production of electricity. It was the concentrated energy of coal that fueled the industrial revolution. The coal era was a time of great industrial and railroad expansion.

After about 1950, oil replaced coal as the source of most of our Nation's energy. The automobile was the reason that oil became an important source of energy. Gasoline and diesel fuel are made from oil. Besides making fuel for vehicles, other major uses of oil are burning it to make electricity and to run industrial machines. At one time, heating oil was commonly used to heat buildings and homes. Natural gas has also grown in importance during this era. It is often found underground along with oil. Because it burns cleanly, it has become the foremost fuel for heating buildings.

Throughout most of human history, people relied on wood to supply their meager energy needs. Wood is a renewable resource; that is, trees can be grown to replace the wood burned for fuel. In the last 100 years, we have become dependent upon coal and oil—fossil fuels. These are nonrenewable resources; once we use them, they are gone forever. It is important that we consider the implications this holds for the future.

Terms

coal: a major fuel resource formed from the remains of ancient plants.

nonrenewable: not able to be restored or replenished.

oil: a mixture of liquids formed from the remains of ancient living things; the source of many important fuels (such as gasoline, diesel fuel, and kerosene) and other substances.

renewable: able to be restored or replenished.

PROCEDURE

I. Setting the stage

A. Introduce the lesson by leading the students in the following discussion.

1. Ask the students the following questions:

- a. What is energy? (the ability to do work)
- b. How do you think early people got their work done; that is, what energy forms did they use? (bodily strength, fire, animal power, and so on)
- c. Have the students give a definition for fuel. (something burned for energy)

2. Share the background information about energy eras with the class, explaining the concept of energy eras and discussing each era as you proceed. List on the board the major uses of the chief energy source for each energy era.

B. Discuss the ancient use of fire with the students.

1. Read the statement about fire by Pliny (Plinnee). There were two famous Romans named Pliny. They were relatives. One was called the Elder and was a famous writer. His book called Natural History is one of the most famous ancient books. Pliny the Elder died in the volcanic eruption that buried the city of Pompeii in 79 A.D.

We cannot but marvel at the fact that fire is necessary for almost every operation. It takes the sands of the earth and melts them, now into glass, now into silver, or minium, or one or other lead, or some substance useful to the painter or the physician. By fire minerals are disintegrated and copper produced; in fire iron is born, and by fire it is subdued; by fire gold is purified; by fire stones are burned for the binding together of walls of houses... It is only when ignited and quenched that charcoal itself acquires its characteristic powers, and only when it seems to have perished that it becomes endowed with greater virtue.

Pliny, Natural History, Vol. XXXVI

(NOTE: Explain to the students that "minium" means red lead, a lead oxide used as a paint pigment. Smelting is the word we use today for the process by which we use heat to get copper, iron, and other minerals from the rocks in which we find them. "Subdued" means tempering iron or altering its hardness. "Stones are burned" means making the lime used in mortar and cement from rocks and shells.)

2. Tell the students that we have used fire for thousands of years. In fact, we can see that we have used fire to do many of the same processes for a long time. Today we still have many uses for fire, and all of them require a fuel of some sort. The earliest common fuel was wood; then came the coal era and the oil era. Today we are developing ways to use nuclear energy.
- C. Tell the students that nuclear energy is our newest energy source. Nuclear energy is fundamentally different from all the major fuels. We use it to produce electricity, and, although the process requires uranium as "fuel," there is no fire involved. Read this Isaac Asimov statement concerning nuclear power to the students.

"Nothing in the history of mankind has opened our eyes to the possibilities of science as has the development of atomic power. In the last 200 years, people have seen the coming of the steam engine, the steamboat, the railroad locomotive, the automobile, the airplane, radio, motion pictures, television, the machine age in general. Yet none of it seemed quite so fantastic, quite so unbelievable, as what man has done since 1939 with the atom....there seem to be almost no limits to what may lie ahead; inexhaustible energy, new worlds, everwidening knowledge of the physical universe."

Isaac Asimov

II. Activity

- A. Have the students make floats from shoeboxes for an energy history parade.
1. Divide the class into three groups—one each for the wood era, coal era, and oil era.
 2. Have each group design its floats to depict lifestyles characteristic of each era in as many ways as possible. Each group should do several floats.
 3. The sun should be used as the leading float (Grand Marshall) to show that it is the major source of all energy. The wood, coal, and oil era floats will follow (in that order). You should make the sun float yourself.
- B. Have the students investigate energy history further.
1. Have the students make a giant "Energy History" collage by cutting out and/or drawing pictures of inventions made possible by the discovery and harnessing of new energy sources through history. The collage should be mounted on a large sun shape to show that the sun is the source of almost all the energy we use.
 2. Have the students choose energy inventions and design shadow boxes to show how life was made easier as a result of those inventions. Divide the class into three groups—one each for the wood, coal, and oil eras. Each student is then to write a story describing his/her group's shadow box scene; the story is to use the first person "I."
- C. Have the students review energy history. Distribute copies of the student sheet "ENERGY IN USE," included. Discuss with them their answers to the questions.

III. Follow-up

- A. Give each student a copy of the student sheet "WHAT MAKES IT GO?," included. Specify how many energy sources and inventions used in each era they are to draw on the sheet.

- B. Have each group write a skit about the different fuel usage eras. Divide the class into four groups—wood era, coal era, oil era, and common, everyday fuel usage. The students should present their plays to the class; costumes, props, and sets may be as simple or elaborate as you wish.

IV. Extension

- A. Have the students write an energy history-related acrostic for the words "Energy History."
- B. Some students may design an energy history mural. (Be sure they include the sun as the source of almost all the energy on earth.)
- C. Interested students may pursue energy history information further.
1. Some students may research the lives and careers of some of the following people famous in energy history: Andre-Marie Ampere, Edwin L. Drake, Henry Bessemer, Thomas A. Edison, Michael Faraday, Robert Fulton, William Kelly, Benjamin Franklin, William Hart, George Ohm, James Watt, Alessandro Volta, Albert Einstein, Ernest Rutherford, Isaac Asimov, and others.
 2. Some students might be interested in collecting stamps. They may write to the Technical Information Center, P.O. Box 62, Oak Ridge, TN 37830 for a booklet called Stamps Tell the Story of Nuclear Energy by Joseph A. Angelo, Jr. (Library of Congress Catalog Card Number: 73-600332). The booklet could then be shared with the class.

RESOURCES

Abruscato, J. Holt Science Skillbook. New York: Holt, Rinehart, & Winston, 1984.

Asimov, I. Solar Power. New York: Walker & Co., 1981. (pp. 9-42)

The Energy Source Education Council. Power Switch (learning unit). Lakewood, CA: Author, 1984. (Address: 5505 East Carson Street, Suite 250, Lakewood, CA 90713.)

Follman, I. L. and H.C. Jackson. Light. Universe. Plants. Energy. St. Louis, MO: Milliken, 1979. (pp. 19-21)

Georgia Environmental Project. Solar Energy (pamphlet). Atlanta: Author, 1987.

ENERGY IN USE

Fill in the blanks below by choosing from the listed words.

COAL

OIL

WOOD

1. In 1850, _____ was used to heat most homes.
2. Diesel fuel is made from _____ and is used by farmers for their tractors. They use their tractors to plow the fields and grow food.
3. Gasoline is made from _____ and is used to run automobiles.
4. Kerosene was used in lamps to light houses in the early 1900s. Kerosene is made from _____.
5. _____ was used to heat water for washing clothes in the early 1800s.
6. In 1900, one-room schoolhouses were often heated by _____.
7. _____ and _____ are used in power plants to produce electricity.
8. _____ is the fuel that prehistoric people used.
9. _____ is the fuel the people of Pliny's day would know best.
10. Steam engines that pulled trains and paddled ships in the late 1800s were powered by _____.

WHAT MAKES IT GO?

Draw and label the energy sources, uses, and inventions used most in each era.

| WOOD (before 1885) | COAL (1885-1950) | OIL (1950-present) |
|--------------------|------------------|--------------------|
| | | |

OH! HOW THE WIND BLOWS!

OBJECTIVES

The student will do the following:

1. Describe the effects of the wind.
2. Estimate the speed of the wind using the Beaufort Wind Scale.
3. Record the wind speeds at different times of the day.
4. Infer the time of day at which the strongest winds usually occur.

SUBJECT:

Science

TIME:

50 minutes plus 30 minutes per day for a week

MATERIALS:

butcher paper, crayons or markers, student sheets (included)

BACKGROUND INFORMATION

Wind results when the sun's heat causes air masses to expand and rise. Cold air rushes in to replace the less dense warm air and wind is created. Wind power can be harnessed to provide some or all of the power for many tasks such as pumping water or generating electricity.

Terms

gale: a very strong wind.

hurricane: a storm with violent wind and (usually) heavy rain; forms over the ocean in tropical regions; term "hurricane" is used in the Western hemisphere; term "typhoon" is used in the Eastern hemisphere.

wind vane: a device used to indicate the direction of the wind.

PROCEDURE

I. Setting the stage

A. Have the students think about wind and energy.

1. Ask the students the following questions about wind:
 - a. What are some things that you see outside that tell you the wind is blowing?
 - b. Describe how you look when the wind is blowing against you.
2. Share with the students the background information about wind power.

- B. Give each student a copy of the student sheet “THE BEAUFORT WIND SCALE,” included. Read and discuss each Beaufort number, description, and observation with the students. Define any terms with which they are not familiar.

II. Activity

- A. Have the class estimate wind speed.
 1. Take the students outside and have them observe the effects of the wind—for example, swings moving, students’ hair blowing, or leaves rustling.
 2. Using the student sheet “THE BEAUFORT WIND SCALE,” have the students estimate the speed of the wind.
 3. Ask the students the following questions:
 - a. What if the wind began blowing very hard? What would the schoolyard look like then?
 - b. What should you do for safety in high winds?
 4. When the students return to the classroom, have them draw a mural depicting a windy playground scene.
- B. Have the students estimate and record wind speeds.
 1. Distribute copies of the student sheet “ESTIMATING WIND SPEED,” included.
 2. Have the students observe and estimate (using the Beaufort Wind Scale) the wind speed at three different times each day for one week. The estimated wind speeds are to be recorded in the data chart on the student sheet.
 3. After the five days of data collection, discuss with the students the wind speeds they observed.
- C. Using the collected data, complete the following:
 1. Have the students make a bar graph showing the morning, noon, and afternoon speeds for each day. (Each day should be represented by three tightly grouped bars; there will be five groups of three bars each.)
 2. After the students have completed their bar graphs, ask them if there seems to be a time of day at which the fastest winds usually occur.

III. Follow-up

- A. Discuss with the students the completed data charts. Orally compile their various answers. Using the Beaufort Wind Scale, identify the different activities happening at the Beaufort Numbers they selected. Ask about other things they might have seen.
- B. Discuss with the students the completed charts and bar graphs. Ask them to consider the times of day in which the highest speeds occurred. If their community decided to use wind power as a source of energy, what appears to be the best time of day to produce the most energy? Why?

IV. Extension

Choose from the following activities:

- A. Have the students write a story entitled "I Could Not Believe What I Saw the Wind Doing."
- B. Have interested students write a poem about the wind. They may brainstorm together for words that rhyme with wind. The words may be written on the board for students who need extra help.
- C. Have each student write a haiku about the wind. These could be written on posters and illustrated.
- D. Have the students make and test a windmill. Use the student sheet "HOW TO MAKE A WINDMILL," included.
- E. Some students may research wind power and write reports about the advantages and disadvantages of using wind power.
- F. Have the students make weather vanes. Each student will need a straight pin, a pencil, scissors, a straw, some clay, and construction paper. Provide patterns so the students can cut the arrows and tails of their wind vanes from construction paper. They will then make a cut at each end of the straw and insert the arrow in one end and the tail in the other. The pin is to be stuck through the center of the straw and pushed into the eraser end of a pencil. The pencil point is to be inserted into a cone-shaped lump of clay so that it will stand upright. The weather vanes the students will have made can be put outside the classroom to show the direction of the wind.
- G. Have the students use maps, weather statistics, and other resources to determine where in the Tennessee Valley one could most likely make use of wind power. Have them explain why this is the case.

RESOURCES

American Museum of Science and Energy. "At What Time of Day Is There Enough Wind To Make Electricity Where You Live?" Science Activities in Energy. Oak Ridge, TN: Oak Ridge Associated Universities, n.d.

_____. "Where Is the Windiest Spot on Your School Ground?" Science Activities in Energy. Oak Ridge, TN: Oak Ridge Associated Universities, n.d.

National Science Teachers Association. The Energy We Use (Grade 1, Energy, Environment, and the Economy). Oak Ridge, TN: U.S. Department of Energy, 1976. (p. 42)

THE BEAUFORT WIND SCALE

| Beaufort Number | Description | Observation |
|-----------------|--------------------------------|-------------------------------------|
| 0 | Calm (0-1 mph) | Smoke rises vertically. |
| 1 | Light air (2-3 mph) | Smoke drifts slowly. |
| 2 | Slight breeze (4-7 mph) | Leaves rustle; wind vanes move. |
| 3 | Gentle breeze (8-12 mph) | Twigs move; flags extended. |
| 4 | Moderate breeze (13-18 mph) | Branches move; dust and paper rise. |
| 5 | Fresh breeze (19-24 mph) | Small trees sway. |
| 6 | Strong breeze (25-31 mph) | Large branches sway; wires whistle. |
| 7 | Moderate gale (32-38 mph) | Trees in motion; walking difficult. |
| 8 | Fresh gale (39-46 mph) | Twigs break off trees. |
| 9 | Strong gale (47-54 mph) | Branches break; roofs damaged. |
| 10 | Whole gale (55-63 mph) | Trees snap; damage evident. |
| 11 | Storm (64-72 mph) | Widespread damage. |
| 12 | Hurricane (73-82 mph) | Extreme damage. |

ESTIMATING WIND SPEED

Observe the wind at 8:00 a.m., 11:00 a.m., and 2:00 p.m. each day for five days in a row. Use the Beaufort Wind Scale to estimate the wind speed. Record the Beaufort number in the chart each time the wind is observed. For example, if you observe leaves rustling on Monday at 8:00 a.m., record "2" in the 8:00 a.m. Monday box.

| | Monday | Tuesday | Wednesday | Thursday | Friday |
|------------|--------|---------|-----------|----------|--------|
| 8:00 a.m. | | | | | |
| 11:00 a.m. | | | | | |
| 2:00 p.m. | | | | | |

HOW TO MAKE A WINDMILL

Materials: windmill pattern, straight pin, pencil with an eraser, scissors

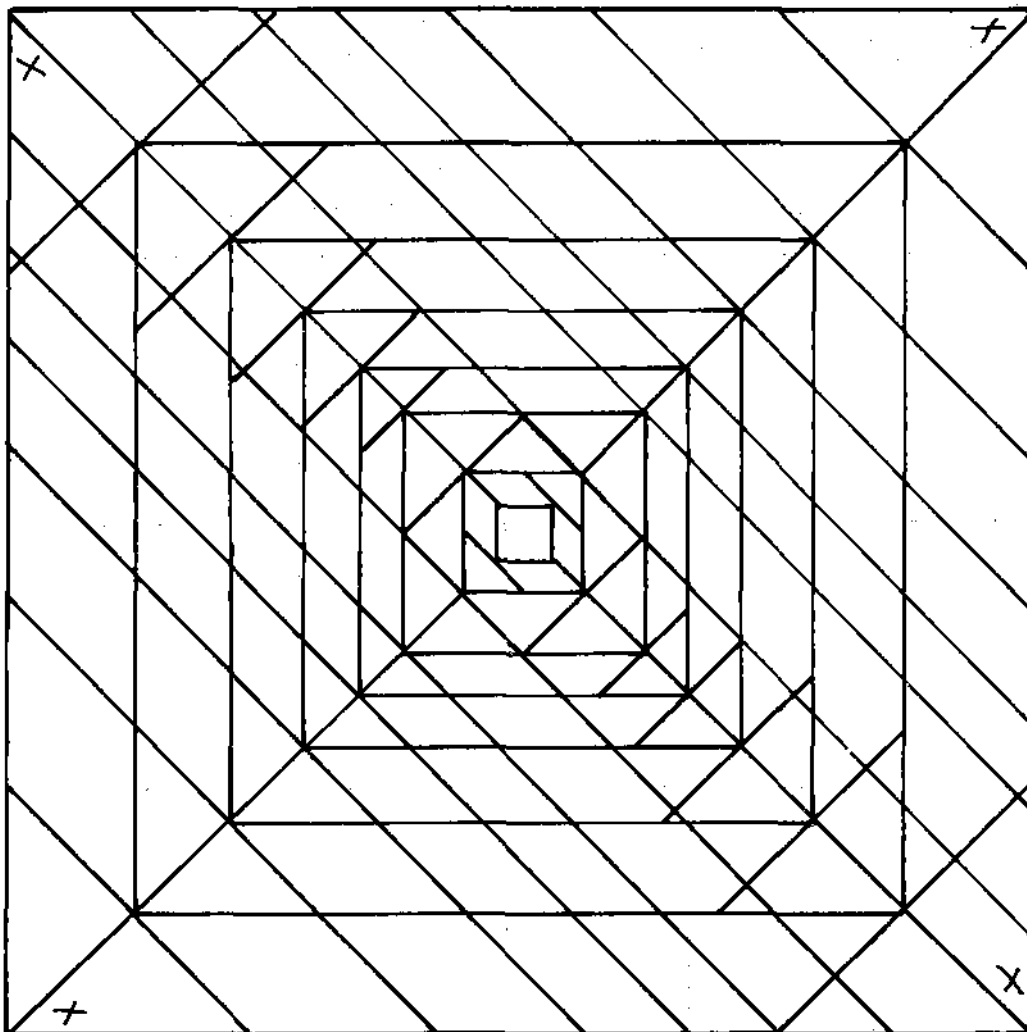

1. Cut in at each corner.
2. Fold up corners marked X.
3. Pin corners to the center.
4. Pin onto eraser of pencil.

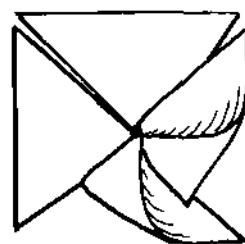
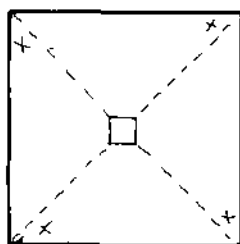

Does the pinwheel move faster when you blow harder? Why? Can you see a problem in the use of wind as an energy source?

ENERGY FROM WATER—FREE FOR THE TAKING

OBJECTIVES

The student will do the following:

1. Draw and label the basic stages of the water cycle.
2. Recognize that flowing water provides energy.
3. Build a model showing that moving water provides energy.

SUBJECT:

Science

TIME:

100-150 minutes

MATERIALS:

teacher sheets (included), milk cartons, scissors, razor knife, compass, ruler, pencil, long thin nail, button, string, stapler, student sheets (included)

BACKGROUND INFORMATION

The water cycle—powered by the sun—provides an endlessly recycled energy resource—flowing water. Water evaporates as the sun's rays shine down on the earth's surface. The water vapor condenses in the air, forming clouds and causing rain to fall. Falling rain keeps rivers flowing. Flowing water can provide energy for people to use.

Thousands of years ago, ancient people invented water wheels—devices that harnessed the energy of flowing water for tiring and time-consuming work like grinding grain. As more machinery was developed, water wheels became used for many more purposes (milling lumber, finishing textiles, operating bellows in metal-working factories, among others). Eventually, the refinement of water wheels led to the development of turbines, which are more efficient and powerful.

With the development of devices that use electricity and the leap in demand for it, turbines were used to generate electricity. In order to generate commercial (large) quantities of electricity, turbines must spin very rapidly. This means that the water must strike the turbines with great force. Constructing dams across rivers allows water to be stored so that it can be used to generate power whenever needed and creates the force needed by the turbines. To generate electricity, a control gate in the dam is opened, allowing water to rush through a tunnel-like passage before striking the turbine. As the turbine spins, it in turn spins the generator. Within the generator, the spinning causes electricity to be generated. This hydroelectric power (electricity from flowing water) is then sent through the power system to be used for for the many ways in which electricity makes our lives easier.

Hydroelectric generation is, in many ways, the best way to generate the amounts of power we demand. No fuel is required, so it is both cleaner and cheaper than other conventional ways of generating electricity (fossil fuel-burning plants and nuclear plants). In the Tennessee Valley, where rivers are abundant, hydroelectricity is an important part of the energy picture.

Terms

dam: a structure built across a waterway; by blocking the flow of the waterway, a dam allows water to be stored behind it for hydroelectric generation or for control of water levels in the waterway.

generator: a machine that changes mechanical energy into electrical energy.

hydroelectricity: electricity produced using the energy of flowing water.

turbine: a device in which a bladed wheel is turned by the force of jets of water (or steam); connected by a shaft to a generator.

water cycle: the natural cycle in which water evaporates from the surface of the earth, rises through the atmosphere, condenses, and returns to earth as precipitation.

water wheel: a wheel having blades or buckets and mounted on an axle; water striking the blades or buckets causes the wheel to turn and powers the machinery attached to the axle; turbines are modern versions of water wheels, which have been used for thousands of years.

PROCEDURE

I. Setting the stage

- A. Share the background information as appropriate with the class.
- B. Show the students a glass of water and ask the following questions:
 1. Do you think this water can produce energy? How could it do this? (Lead the students to realize that the energy of moving water could be used.)
 2. Does using water “use it up?” (Lead the students to recognize that we do not consume water when we use it; water is continuously recycled.)
- C. Make a transparency of the teacher sheet “THE WATER CYCLE” (included), and use it to review the water cycle with the students.
- D. Discuss with the students the fact that using water’s energy requires no fuel and produces no pollution, and that water is free for the taking.

II. Activity

- A. Investigate how the energy of falling water is used.
 1. Share with the students the following information:

Today we are going to learn about the energy of falling water. We will do this by making and using a waterwheel or turbine. Some power plants use falling water for the energy from which they make electricity. Water held behind a dam is released through large pipes down to a nozzle. The water squirts out of the nozzle with great force, hitting a water wheel (turbine) and making it spin. This spinning turbine drives the generator that makes electricity. This is how we get electrical energy from falling water. Electricity from falling water is called hydroelectric power.

2. Give each student a copy of the student sheet "HOW TO MAKE A WATER WHEEL," included. Give each student the materials listed on the student sheet.
3. Have each student demonstrate how the water wheel works at a sink or by holding it over a pan and having a helper pour water onto it.

B. Investigate how hydroelectric dams work.

1. Tell the students that we live in the Tennessee Valley region. Some of our electricity comes from dams. There are about forty hydroelectric dams in the Valley region. Ask the students if they can name the seven states that are a part of the Valley region. (Tennessee, Alabama, Georgia, Mississippi, Kentucky, Virginia, and North Carolina)
2. Make a transparency of the teacher sheet "HOW A DAM WORKS," included. Discuss with the students how a dam uses the energy of falling water to produce electricity. A dam is used to store water. A gate in the dam releases water through the dam as it is needed to generate electricity. The water rushes down a long tunnel with tremendous force. It hits the turbine at the bottom of the tunnel and spins it around rapidly. This spinning drives the generator which makes electricity.
3. Divide the students into groups of three or four. Give each group a copy of the student sheet "A HOMEMADE DAM" (included) and the materials needed to build the models of dams. Have them build the models.
4. Have the students demonstrate how the energy of falling water spins turbines by holding the models above the turbines they built and releasing water onto the turbines.

III. Follow-up

A. Have each student draw and label the basic stages of the water cycle.

B. Ask the following questions:

1. How did we prove that flowing water provides energy? (Discuss the student activity.)
2. What is another word for water wheel? (turbine)
3. What do we call the electric power that we generate using falling water? (hydroelectric power or hydroelectricity)
4. What is the name of the machine that changes the energy of the spinning turbine into electrical energy? (generator)
5. What is one reason we build dams? (so we can use water power to produce electricity)
6. Name three advantages of using falling water to produce electricity. (pollution-free, uses no fuel, no cost for the water)

C. Have the students write a paragraph describing how flowing water is used to produce electricity in a dam. A second paragraph describing the advantages of using water energy to produce hydroelectricity should be written.

IV. Extension

- A. Have the students make a collage of magazine pictures showing ways we use electricity.
- B. The students may write haikus about the water cycle. A haiku has three lines—the first has 5 syllables; the second has 7 syllables; and the third has 5 syllables.
- C. Have the students make posters of the water cycle.
- D. Have the students research careers related to hydroelectric power.
- E. Plan a field trip or encourage students to visit a dam that is a hydroelectric generating plant.

RESOURCES

Fritz, S. "Power From The Ocean Tides." *Science World*, March 30, 1984. (pp. 12 - 14)

Gutnik, M. J. *Energy: Its Past, Its Present, Its Future*. Chicago: Children's Press, 1975. (p. 16)

Hall, M. Y. "Flowing Water." *Simple Science Experiences*. N.p.: N.p., 1972. (p. 8)

Keen, M. L. *The How and Why Wonder Book of Science Experiments*. Brooklyn, NY: Grosset and Dunlop, 1971. (pp. 23-24)

Payne, S. N. *Wind and Water Energy*. N.p.: Raintree, 1983. (pp. 21-31, 46)

Schneider, H. and N. Schneider. *Science In Our World*. Boston, MA: Heath, 1964. (pp. 148, 149)

THE WATER CYCLE

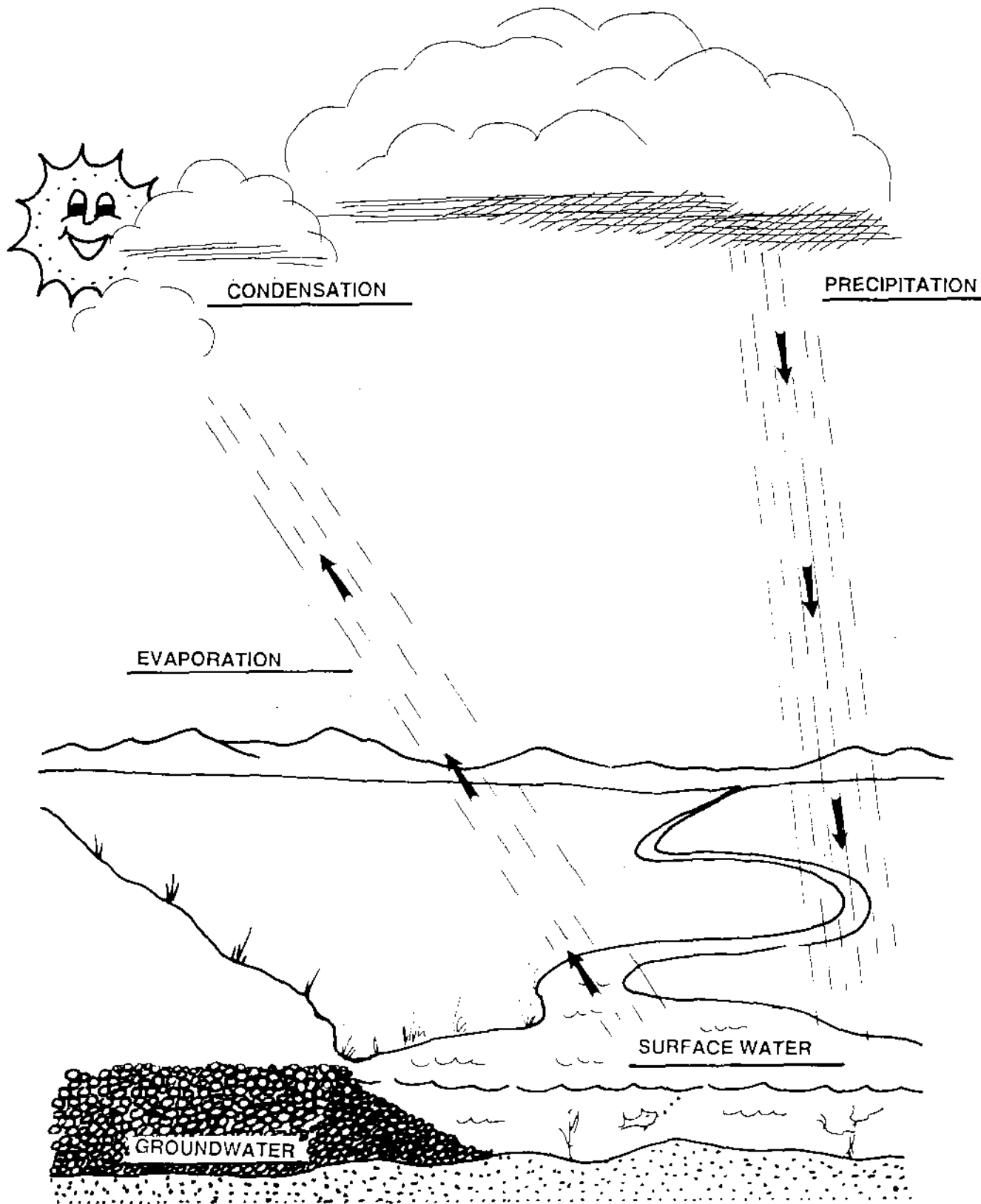

HOW TO MAKE A WATER WHEEL

Materials: milk carton, scissors, compass, ruler, long nail, piece of string, button

1. Cut a side out of a milk carton.
2. Use a compass or a pattern to draw a circle on the side of the milk carton. Cut it out.
3. Use a ruler to draw two dotted lines that divide the circle into fourths. (Be sure the lines go through the center of the circle.) Cut along the dotted lines, but not through the center.

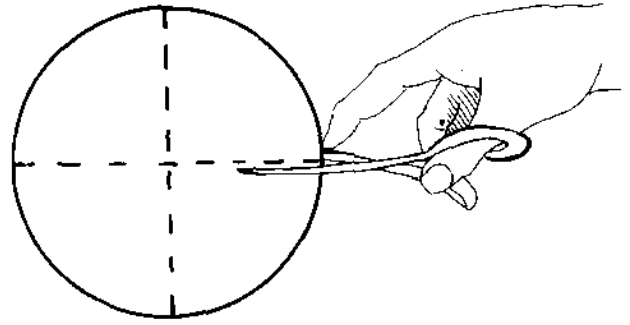

4. Fold down the edge of each fourth. (See the picture.)
5. Put a nail halfway through the center of the circle. (Leave about half of the nail on each side of the circle.)

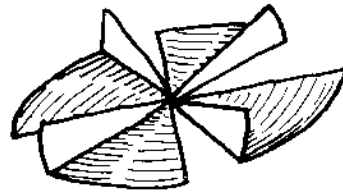

6. Make your water wheel do some work. Attach a button to one end of a piece of string. Tie the other end to the nail. Now, hold the water wheel under running water. The water will turn the wheel. The string will wind around the nail and lift the button.

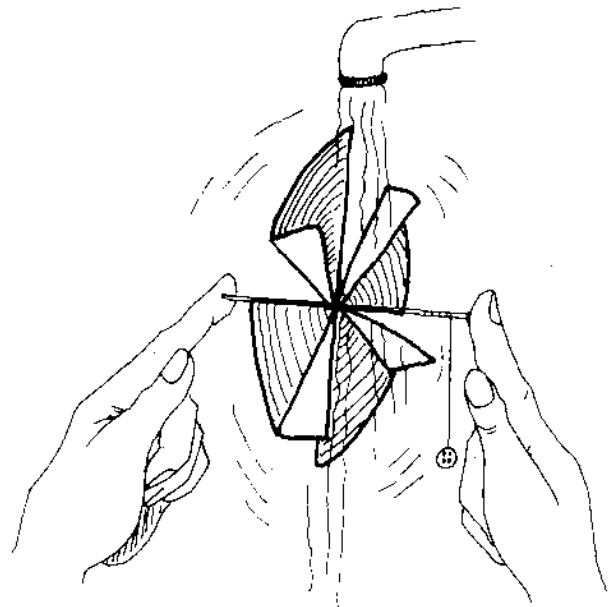

HOW A DAM WORKS

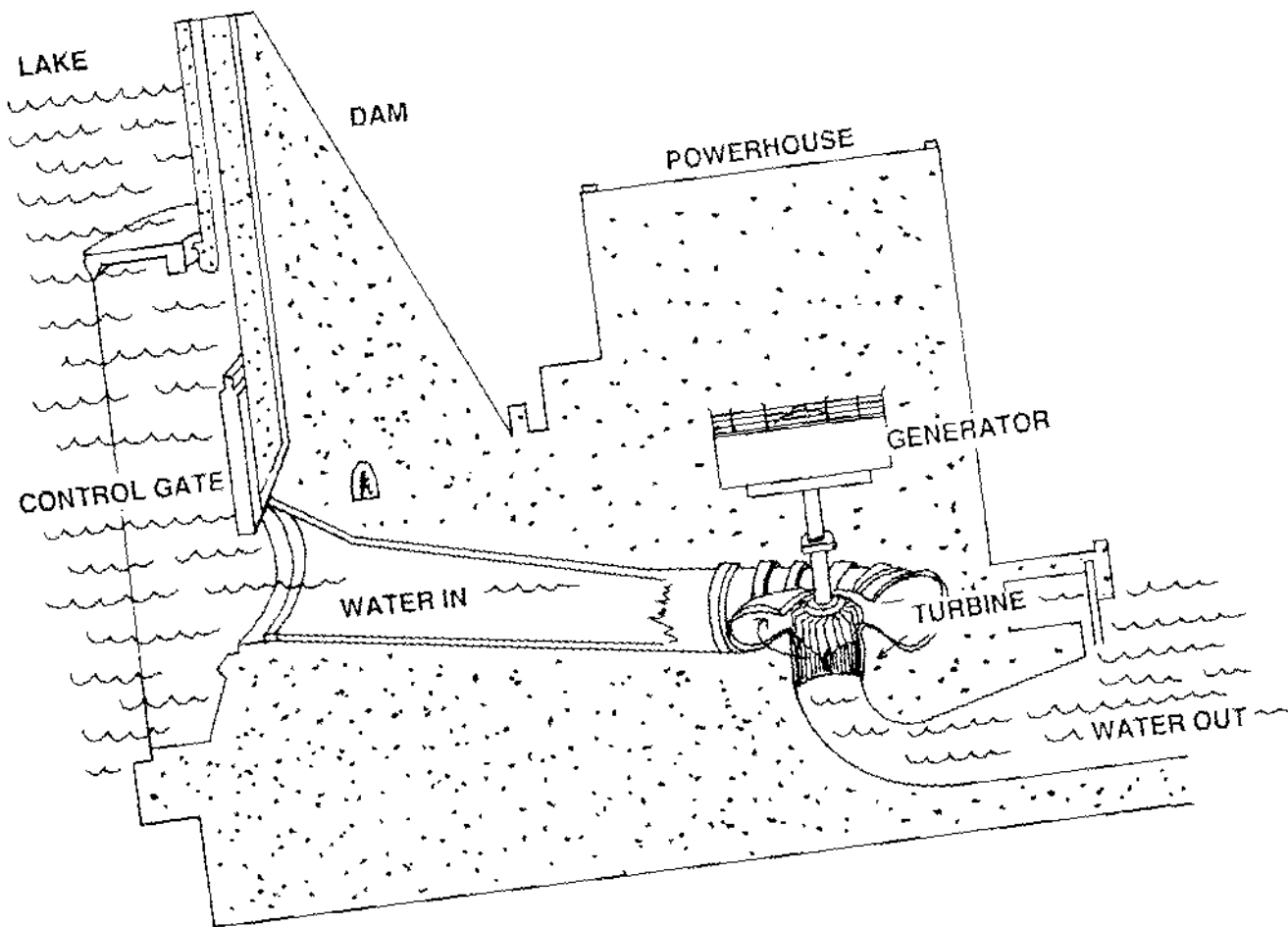

A HOMEMADE DAM

Materials: milk carton, scissors or razor knife, ruler, stapler

1. Cut out one side of the carton.
2. Cut two pieces (2" long x 1" wide) from the side you cut out of the carton. Keep the piece that is left over; you will use it, too.

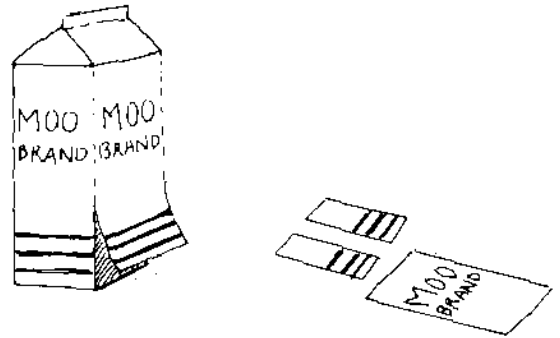

3. Cut a square hole about 1/2" wide and 1/2" high out of the bottom of the carton. It should be closer to the back of the carton than to the side you cut out.

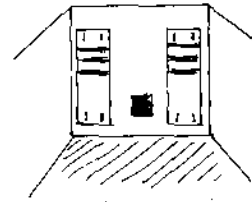

4. Staple the 2 strips onto the inside of the carton on either side of the square hole.

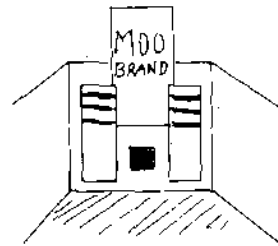

5. Use the leftover piece to cut a strip that will fit snugly between the two stapled pieces. Tuck its edges between the stapled-on strips and the carton's bottom. Slide it up and down to make sure it covers the little square hole and it moves.

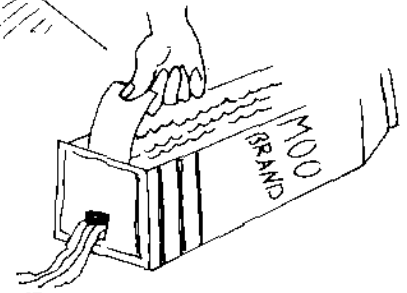

6. Cover the square hole and fill the carton with water. Now you have a model of a lake and a dam.

7. Pull up the strip. It acts as the gate on the dam. What happens when you open and close the gate?

TO BURN OR NOT TO BURN

OBJECTIVES

The student will do the following:

1. Examine the advantages and disadvantages of burning wood for energy.
2. Observe a demonstration of fire safety measures.
3. Identify the conditions necessary for burning.

BACKGROUND INFORMATION

Wood is a renewable energy resource because it can be replaced in a relatively short time. More trees can be planted to grow more wood. Fossil fuels such as coal and oil are nonrenewable; we will eventually run out of them because they are not replaceable.

Trees can be divided into two general types. Some trees are softwoods. Most softwoods, such as pine, spruce, and fir trees, are evergreens. They have needles and keep their leaves year-round. Some trees are hardwoods. They are mostly deciduous trees with broad leaves that fall off in winter. Hardwoods usually are much better for use as firewood. The wood tends to burn better and longer, yielding more heat and fewer undesirable by-products than softwoods.

Burning wood for heat can be economical and practical if efficient stoves or fireplaces are used. The efficiencies of fireplaces and stoves have improved in recent years. Economic concerns are not the only reasons to consider wood-burning efficiency, however. Safety and environmental factors also depend on efficiency.

Inefficient wood-burning can produce creosote. This is a substance deposited on chimney walls as smoke flows up the chimney. It is flammable and increases fire hazards. Smoke and pollution must also be controlled. Air quality decreases significantly when people burn large amounts of green wood or use inefficient stoves or fireplaces.

Terms

creosote: a tar-like substance deposited on chimney walls by smoke; results from inefficient burning or the use of woods likely to cause it; increases chimney fire risk.

hardwood: a deciduous or broad-leaved tree, such as oak, hickory, or maple.

SUBJECT:

Science

TIME:

150 minutes

MATERIALS:

shoe boxes, magazines or catalogs, scissors, glue, stiff paper, crayons or markers, (optional) dollhouse miniatures, "tin" can, pine wood chips, wire screen, matches, hot plate or Bunsen burner, bucket of sand, metal pan, box or tub of sand, small pieces of wood, discarded wool blanket, bucket of water, posterboard, student sheet (included)

nonrenewable: not able to be restored or replaced.

renewable: able to be restored or replaced.

softwood: an evergreen or coniferous tree, such as pine, spruce, or fir.

PROCEDURE

I. Setting the stage

- A. Explain to the class that for many thousands of years, firewood was the primary fuel used by people. In fact, for most of our Nation's history, firewood was the fuel used most often. It was burned in fireplaces, open hearths, or in stoves. It provided heat energy for cooking, doing laundry, and for warming homes. Today we depend on electricity, oil, or natural gas to provide most of the energy for these things. (Of course, in many parts of the world, people still depend on wood for energy.)
- B. Show the students how to properly deal with fire with this demonstration. (You may need to do this outdoors.) (**CAUTION: OBSERVE ALL SAFETY MEASURES.**)
 1. Gather the following materials—folder of safety matches, a bucket of sand, a metal pan, a box or tub of sand, small pieces of wood, a discarded wool blanket, and a bucket of water.
 2. Demonstrate the proper way to strike a match. Blow it out, stick its head in the bucket of sand for a moment or two, then put it in the waste basket. Explain that water will work too. One must always be sure a match is cold before disposing of it.
 3. Put some of the wood in the metal pan and place it on top of the sand in the box. Light the wood and allow it to burn for a few moments. Then sprinkle sand from the bucket over the wood. Ask the students what happened to the fire. (Point out that metal does not burn, and that the sand protected the table or floor from the heat.)
 4. Make another fire in the pan. Pour water on the burning wood. Ask the students what happened.
 5. Make a third fire in the pan. Put out the fire by smothering it with the blanket. The wood cannot burn without air. Using sand, water, or a blanket smothers the fire, taking away its air supply. (NOTE: If the demonstration cannot be performed, this can be discussed. Let the students give their ideas of what will occur.)

II. Activity

- A. Have the students make a shoe box diorama of a home representative of either the past or the present. The scene they choose to do must include the source of heat for the home. Let the students choose their materials. They may use dollhouse miniatures, cutouts from magazines (glued to stiff paper), or may make up their own ways of depicting their chosen home scenes.
- B. Investigate the process of burning.
 1. Review with the students the conditions needed for burning to occur—combustible material, flame, and air.

2. Demonstrate heating (but not burning) wood in order to detect some of the products wood gives off when it is heated. (**CAUTION: OBSERVE ALL SAFETY MEASURES.**)
 - a. Put a small piece of pine wood into a "tin" can. Set the can on a piece of wire screen positioned over a heat source such as a Bunsen burner or set it on a hot plate. Turn on the heat.
 - b. Be careful not to let the wood catch fire. The point is to heat the wood to a high temperature.
 - c. Have the students watch what happens as the wood gets hotter and hotter. Ask them what they see. (First, they will see a "cloud" of water that is evaporating from the wood. They may see some brown sap running out of the wood.) Ask them if they smell anything. (The gases that are being driven out of the wood have an odor.)
3. Give each student a copy of the student sheet "FIREPLACE PRODUCTS," included. Explain that burning wood produces a mixture of products. Some of them are driven out of the wood by the heat and given off; some are produced or changed by the fire; and some are materials that are either not burned or are only partially burned.
4. The "product" we desire from burning wood is heat. Discuss with the students how to get the most heat from the wood we burn. In selecting firewood, we must consider the fact that up to half the weight of freshly cut wood is moisture. The more fresh wood can be dried out before it is used for fuel, the more it tends to warm the house (instead of going up the chimney in steam). A minimum of six months' time is needed to season most wood. Selecting the best kind of wood is also vital. The best firewoods are hardwoods. Softwoods will burn, but do not last as long; they also tend to deposit a substance called creosote on the stovepipe or flue, creating a chimney fire hazard. (NOTE: You may need to review the definitions of hardwood and softwood with the students.)
- C. Have the students examine the advantages and disadvantages of using wood for energy. Divide the students into groups and have them conduct library research on the pros and cons of using wood as an energy source. Have each group prepare a presentation for the class about the advantages and disadvantages of burning wood. Each group should make and use posters in its presentation.

III. Follow-up

Ask the students the following questions:

- A. What has been the major source of energy (fuel) for most of human history? (wood)
- B. Which diorama did you choose—past or present? What source of heat did you depict in use in your diorama? Why?
- C. What conditions are needed for burning to occur? (combustible material, flame, air)
- D. What are the two kinds of wood? (hardwood and softwood) Which kind is best for heating? (hardwood)
- E. Name three products of burning wood. (Examples are heat, water vapor, carbon dioxide, ashes, and so on.)

- F. Name three ways to put out a fire. (smother with water, sand, or a blanket)
- G. Name two advantages and two disadvantages of using wood as an energy source. (Answers will vary according to class presentations.)

IV. Extension

- A. Choose from the following activities:
 - 1. Have the students read selections from the Foxfire series (by Eliot Wigginton) for information about lifestyles in which wood is a major energy source.
 - 2. Have interested students research different kinds of stoves and fireplaces. They may write reports or draw the various styles.
 - 3. Have someone find out about "sharing fire" in frontier days.
 - 4. Have the students do a report on one of Benjamin Franklin's inventions, the wood-burning Franklin stove.
- B. Have the students find out about buying firewood in their community. Have them find out what a cord of wood is, how much a cord of wood costs, and what a "rick" of wood is. How does a rick differ from a cord?

RESOURCES

American Museum of Atomic Energy. "How Long Will It Take For a Birthday Candle to Use Up the Oxygen In a Glass?" Science Activities in Energy—Chemical Energy Unit. Oak Ridge, TN: Oak Ridge Associated Universities, n.d.

Heating and Cooling. Richmond, VA: Time Life Books, 1977. (p. 79)

How to Plan and Build Your Fireplace. Menlo Park, CA: Sunset Books, 1972.

Mack, N. Back to Basics. Pleasantville, N.Y: Reader's Digest, 1981. (pp. 82-93)

Ross, B. and C. Ross. Wood-burning Stoves and Grassroots Energy Revival. Woodstock, NY: Overlook Press, 1976. (Chap. 4)

Trowbridge, L. W. Accent On Science. Columbus, OH: Merrill, 1983. (p. 35)

Vivian, J. Wood Heat. Emmaus, PA: Rodale, 1978.

FIREPLACE PRODUCTS

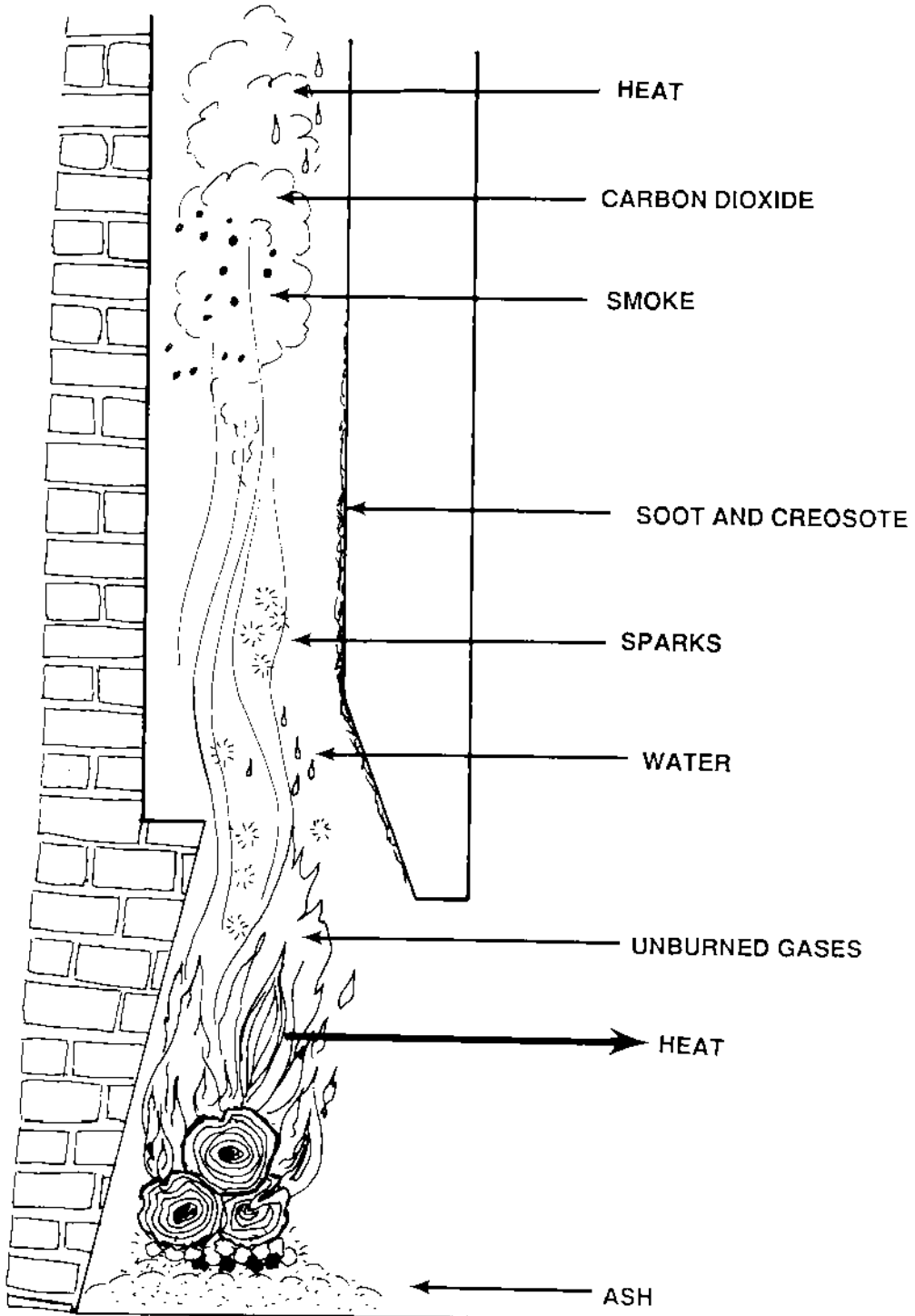

GLOSSARY

- creosote:** a tar-like substance deposited on chimney walls by smoke; results from inefficient burning or the use of woods likely to cause it; increases chimney fire risk.
- coal:** a major fuel resource formed from the remains of ancient plants.
- dam:** a structure built across a waterway; by blocking the flow of the waterway, a dam allows water to be stored behind it for hydroelectric generation or for control of water levels in the waterway.
- food chain:** a path by which energy and materials pass from one living thing to another in the form of food.
- gale:** a very strong wind.
- generator:** a machine that changes mechanical energy into electrical energy.
- glazing:** glass or other transparent material (such as is used for windows) used to trap solar energy in a solar device or building.
- hardwood:** a deciduous or broad-leaved tree, such as oak, hickory, or maple.
- heat storage materials:** materials such as concrete, rocks, or water, that are capable of absorbing heat energy and slowly releasing it as the atmosphere cools down.
- hurricane:** a storm with violent wind and (usually) heavy rain; forms over the ocean in tropical regions; term "hurricane" is used in the Western hemisphere; term "typhoon" is used in the Eastern hemisphere.
- hydroelectricity:** electricity produced using the energy of flowing water.
- insulation:** material that hinders the flow of heat energy.
- nonrenewable:** not able to be restored or replenished.
- oil:** a mixture of liquids formed from the remains of ancient living things; the source of many important fuels (such as gasoline, diesel fuel, and kerosene) and other substances.
- passive solar system:** a device or structure that does not require mechanical parts to collect, store, and make use of solar energy.
- renewable:** able to be restored or replenished.
- softwood:** an evergreen or coniferous tree, such as pine, spruce, or fir.
- solar collector:** any device used to trap the sun's energy and change it into heat energy.
- solar energy:** the energy we get directly from the sun's rays, especially the heat energy we can trap and use.

turbine: a device in which a bladed wheel is turned by the force of jets of water (or steam); connected by a shaft to a generator.

water cycle: the natural cycle in which water evaporates from the surface of the earth, rises through the atmosphere, condenses, and returns to earth as precipitation.

water wheel: a wheel having blades or buckets and mounted on an axle; water striking the blades or buckets causes the wheel to turn and powers the machinery attached to the axle; turbines are modern versions of water wheels, which have been used for thousands of years.

wind vane: a device used to indicate the direction of the wind.

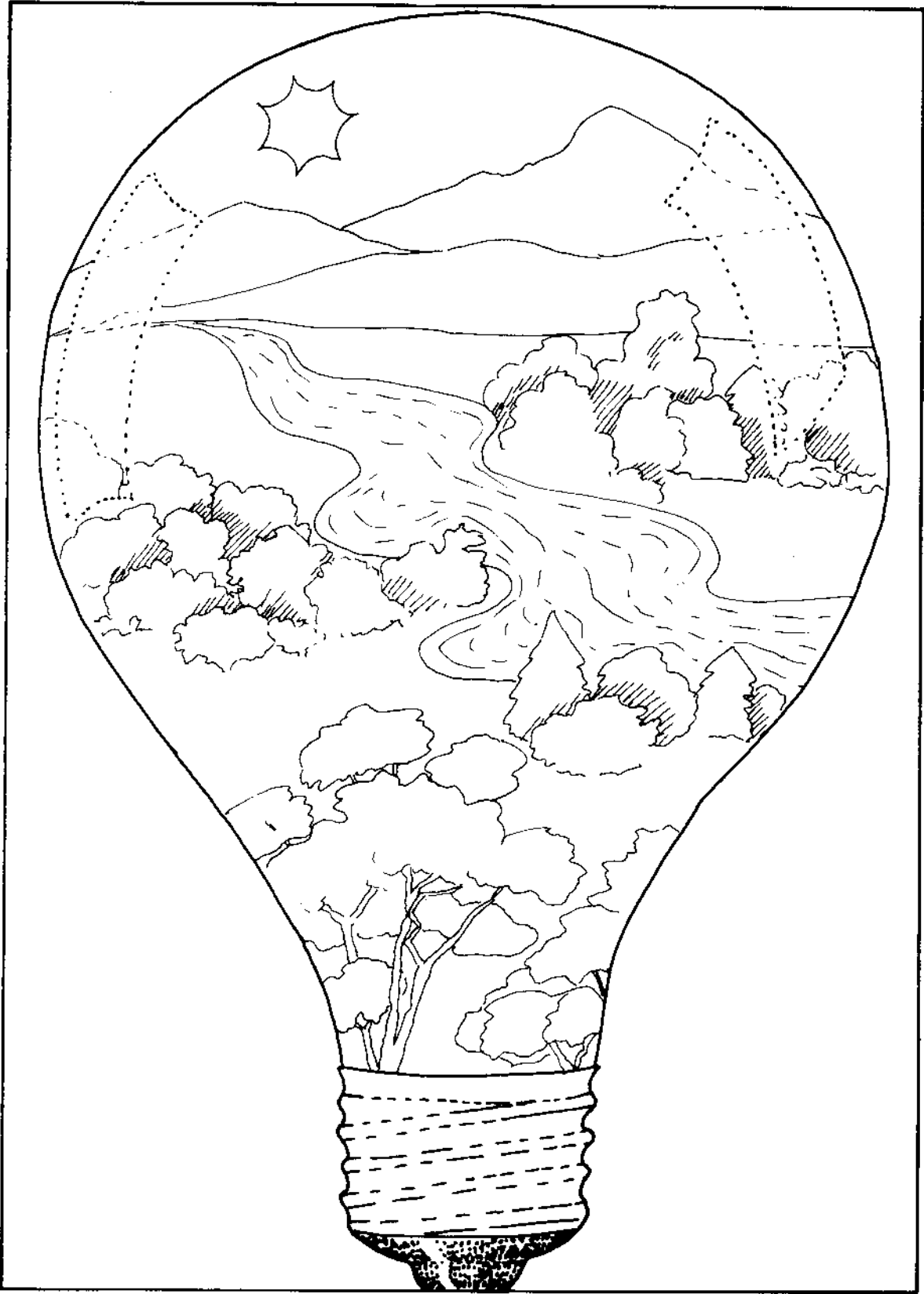

ENERGY AND THE ENVIRONMENT

TO USE OR NOT TO USE

OBJECTIVES

The student will do the following:

1. Explain the significance of decreasing supplies of fossil fuels and increasing demand for electricity.
2. State ways to conserve electricity.
3. Distinguish between renewable and nonrenewable resources.

SUBJECTS:

Science, Math

TIME:

120 minutes

MATERIALS:

pictures of life in America before electricity, overhead projector, transparency (master included), posterboard, construction paper, glue or tape, markers, play money, student sheets (included)

BACKGROUND INFORMATION

Because of our continually rising standard of living and the relatively low cost of electric power to the consumer, our demand for electricity has risen dramatically. Air conditioners, dishwashers, televisions, washers, and dryers, which were considered luxuries 30 years ago, are commonplace today. It is estimated that by the year 2000 over 40 percent of all energy resources will be used to generate electricity.

Fossil fuels—coal, oil, and natural gas—are our primary energy resources. They provide about 80 percent of our electric power. These resources were created millions of years ago. They are considered nonrenewable because the rate at which they are formed again in the earth nowhere near matches the rate at which we use them. For example, some experts predict that the United States' oil reserves will be used up by the year 2035.

Energy conservation is a necessity today. Saving oil, gas, and coal energy today will buy us more time to develop alternative ways to generate electricity, to power our transportation systems, and to produce the many products made from fossil fuels that we have come to take for granted.

Terms

conservation: managing or using a resource wisely and efficiently.

fossil fuels: coal, oil, and natural gas that were formed millions of years ago from the remains of plants and animals.

kilowatt: 1,000 watts.

kilowatthour: 1,000 watts of electricity used for one hour.

nonrenewable resources: resources that are limited and can be used up (such as fossil fuels); resources that cannot be replaced, replenished, or regrown.

renewable resources: resources which cannot be used up (such as the sun or wind) or that can be replaced, replenished, or regrown (such as forests and crops).

resources: supplies of useful or valuable things; things that can be used to make or supply other things.

watt: a unit measuring electricity.

PROCEDURE

I. Setting the stage

- A. Show the students pictures of life in America before electricity. (A good source of these is the Hine posters, which may be available at the centers for environmental education. Check the address listing at the front of the Sourcebook for the center nearest you.) Brainstorm with the students what kind of lifestyles people had before the widespread use of electricity.
- B. Have the students write down all the ways they use electricity in a day. When this task is completed, the students may compare lists.

II. Activity

- A. Introduce the term fossil fuel. Explain that the fossil fuels—coal, oil, and natural gas—were formed millions of years ago when the remains of plants and animals were subjected to extreme heat and pressure. Since it took millions of years to form these fuels, they are considered nonrenewable resources—resources that are limited and can be used up. Contrast this with renewable resources, such as wood or water, which may be ready to be used again in a few days, months, or years. Tell the students that about 80 percent of the energy used to make electrical power today comes from fossil fuels. Point out that supplies of fossil fuels are limited, and some experts predict that supplies of some fossil fuels will be used up in the students' lifetimes if we continue using them at current rates. Thus, it is important to begin practicing conservation—managing or using resources wisely—so that we can make our fossil fuels last longer while we explore alternative energy sources.
 1. Give the students the worksheet, "YOU LIGHT UP MY LIFE" (included). Ask the students to take the worksheet home and record all the electrical appliances they have. The students should then number the appliances in order of importance to them, crossing out any appliances they could do without and still have a good life.
 2. When the students have completed their home appliance inventories, discuss with them the results. Which appliances are least important? Which could they do without?
 3. Tell the students to imagine that energy shortages cause the government to enforce conservation. To do this, a law is made that a family can use only three appliances. Which would they choose? Why did they make that choice?
 4. Ask the students if they would like to return to the times portrayed in the pictures of America before electricity. Remind the students that our supplies of fossil fuels are limited. What conservation practices would they recommend in order to make these supplies last longer?
- B. Give the students the worksheet, "CONSERVATION WORD SCRAMBLE" (included). Let the students work independently or in small groups to find the answers to the puzzle. When the puzzles are completed, discuss with the class the conservation rules given.

- C. To further develop the idea of energy conservation to protect our fossil fuel supplies, play the "Pocket Change" game.
1. Introduce the terms watt, kilowatt, and kilowatt-hour. For example, one kilowatt-hour (kWh) is the amount of electricity that ten 100-watt light bulbs will use in one hour.
 2. Show the students the transparency "COST OF OPERATING ELECTRICAL APPLIANCES" (made from the provided master). Make sure they understand how to read the table. (If you have a supply of TVA "Measure the Energy" Energy Wheels, use them. They are no longer available, but the information on the transparency is taken from the Energy Wheel.)
 3. Have the students note the given differences in cost of operating appliances different ways. For example, running the dishwasher at the normal full cycle would cost 17 cents per use (based on a kWh cost of 6 cents), but a normal load in the dishwasher without using the dry cycle would only cost 15 cents. Tell the students that the average electrical cost in 1988 in the Tennessee Valley was 5.8 cents per kilowatt-hour, but the average for the United States was 7.5 cents per kilowatt-hour. Allow the students to suggest other conservation practices based on information on the transparency.
 4. Introduce the "Pocket Change" game. Have the students check to see how much pocket change they have (or divide a certain amount of play money between the students)
 5. Have the students choose appliances from the "Pocket Change" board (see the included teacher sheet). The students will pull cards from the pockets to see how much they have "spent" from their pocket change (or play money) to operate the chosen appliances.
 6. Encourage the students to choose their appliances carefully and see how much electricity they can buy before using all their pocket change. Relate the game to activity B and the discussion about conservation measures.

III. Follow-up

Use the following to review the activity with the students.

- A. Fill in the blanks with the correct words from this activity.
1. Coal, oil, and natural gas are fossil fuels which were formed millions of years ago when the remains of plants and animals were subjected to extreme heat and pressure.
 2. These fuels can be used up because they are limited in supply and took millions of years to form; they are considered to be nonrenewable resources.
 3. Conservation is the wise use and management of our natural resources.
 4. Wood and water are considered renewable resources because they can be replaced or regrown and be used again in a few days, months, or years.
- B. Write a paragraph explaining the relationship that exists between the decreasing supply of fossil fuels and the increasing demand for electricity. (Accept all appropriate answers and use them for class discussion.)
- C. List six ways to help save electricity and thus decrease the amount of fossil fuels used for electricity production. (Some tips are listed on the student sheet "CONSERVATION WORD SCRAMBLE.")

D. Fill in the blanks with the correct words.

1. A kilowatt hour is equal to 1,000 watts of electricity used for one hour.

2. A unit measuring electricity is a watt.

3. A kilowatt is 1,000 watts of electricity.

E. List three nonrenewable resources which are our fossil fuels. (coal, oil, and natural gas)

F. List three renewable resources which may be used for energy. (sun, wood, water)

IV. Extension

A. Teach the students how to read an electric meter. Look at the student sheet "YOU LIGHT UP MY LIFE." Have the students ask their families not to use the appliances they crossed out for one week. Record the meter reading at the beginning and the end of the week. Compare this figure with the meter reading for a week in which all the appliances are used.

B. Have a scavenger hunt in which the students must find examples of renewable and nonrenewable resources or examples of conservation methods being practiced.

C. Have the students research the pros and cons of car-pooling and mass transit and write radio spots promoting these methods of conservation.

D. Take a field trip to a recycling center. Find out what items can be recycled and how much energy can be saved by recycling.

RESOURCES

Baraufaldi, J. P., G. T. Ladd, and A. J. Moses. Heath Science Series - Grade 4. Lexington, MA: D.C. Heath, 1985.

Tennessee Energy Education Network. "Electrical Appliances in My Home." (Address: Sixth Floor, 320 Sixth Avenue, North, Nashville, TN 37219-5308, ATTN: Ms. Dawson. Telephone: 1-800-342-1340).

_____. "Pocket Change Game." (Address above.)

Thomas Alva Edison Foundation. Energy Conservation Experiments You Can Do. Southfield, MI: Author, 1983.

_____. Energy for the Future. Southfield, MI: Author, 1983.

Tennessee Valley Authority. "Hine Posters." N.p.: Author, n.d.

NOTE: For more information, write the National Energy Foundation, 5160 Wiley Post Way, Salt Lake City, UT 84116. (Telephone: 801-539-1406.)

YOU LIGHT UP MY LIFE

Search your home for all the electrical appliances you use. Write the name of each on a light bulb. Next, go back and number them in order of their importance to you. Then put an X through any appliance you could do without and still have a good life.

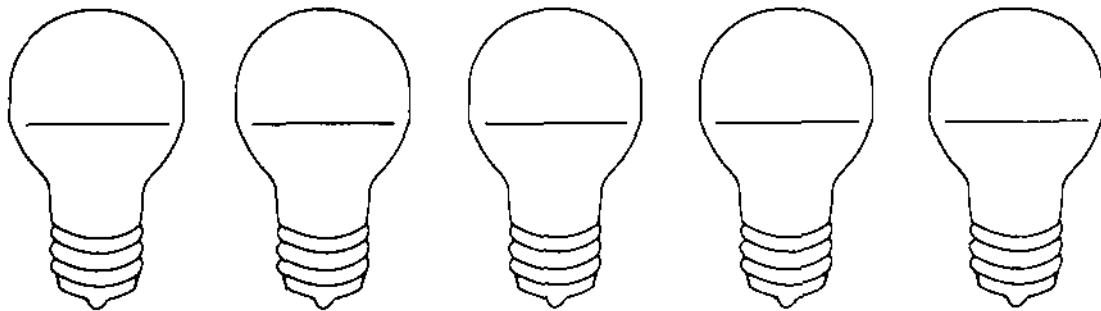
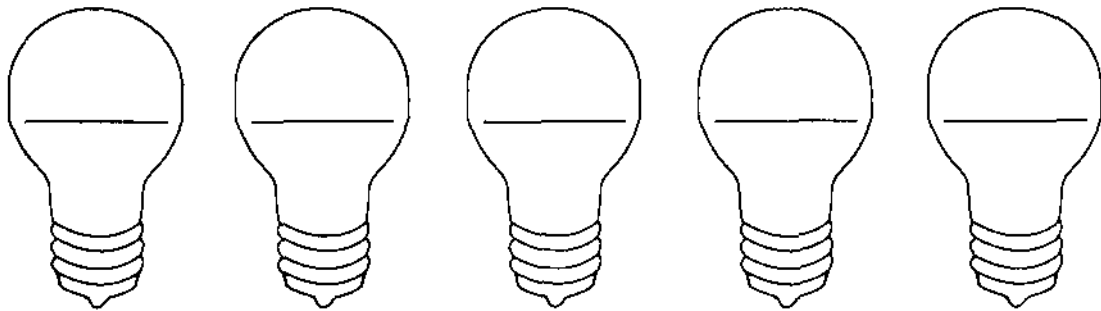
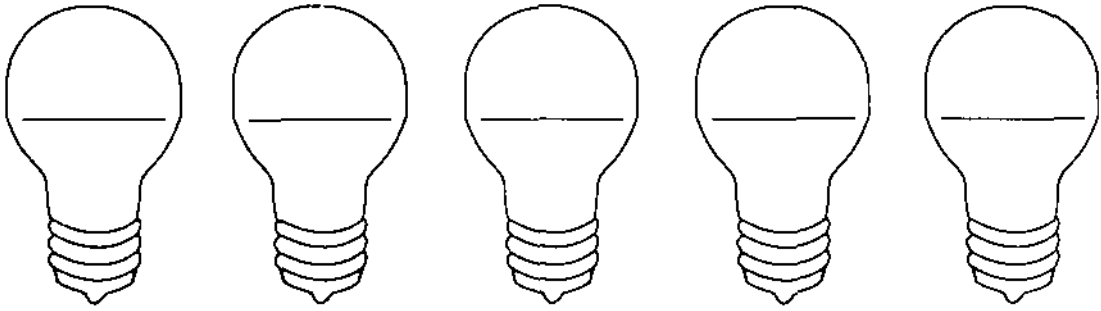

CONSERVATION WORD SCRAMBLE

1. _____
ENVO Preheat this for no more than 10 minutes; don't keep peeking into it.
2. _____
DAIRO Turn this off when no one is listening.
3. _____
WOHSER Take this instead of a bath; keep it short.
4. _____
TINSLAUOIN There should be at least 6 inches of this in your attic and 3 inches in your walls.
5. _____
MTHSTAREO In winter, turn it back to 60 degrees at night or when no one is home.
6. _____
UFTACE When it drips one drop per second, it wastes 900 gallons of water per year.
7. _____
HIWSANG CANEMHI Use cold or warm water in this when possible.
8. _____
KEBI Do this when going short distances.
9. _____
RORTEAFRREIG Open this door only when necessary.
10. _____
REFEERZ Defrost this regularly to save energy.

COST OF OPERATING ELECTRICAL APPLIANCES*

| <u>Appliance</u> | <u>Time Used</u> | <u>Cost (@6¢/kWh)**</u> |
|---|---------------------|-------------------------|
| Color television | 10 hr | 9¢ |
| Stereo | 10 hr | 7¢ |
| Blow dryer | 8 min/day for 1 mon | 24¢ |
| Microwave oven (1,450W) | 30 min | 4¢ |
| Range oven (350°) | 1 hr | 5¢ |
| Refrigerator/freezer (18 cu ft, auto defrost) | 1 mon | \$7.96 |
| Dishwasher, normal full cycle | 1 load | 17¢ |
| Dishwasher, normal without dry cycle | 1 load | 15¢ |
| Light bulb (100W, incandescent) | 10 hr | 6¢ |
| Fluorescent tube (40W) | 10 hr | 2¢ |
| Clothes washer (full load, warm wash/cold rinse) | 1 load | 18¢ |
| Clothes dryer (full load, medium temperature) | 1 load | 15¢ |
| Vacuum cleaner | 1 hr | 4¢ |
| Clock | 1 mon | 9¢ |
| Space heater (1,500W) | 1 hr | 9¢ |
| Window air conditioner (12,000 Btu/hr, EER 6.0) | 1 hr | 12¢ |
| Window fan | 1 hr | 1¢ |
| Water heater (to heat water for full tub bath) | 1 bath | 26¢ |
| Water heater (to heat water for 5-min shower) | 1 shower | 18¢ |

* These costs are estimated and are affected by highly variable factors such as user habits, age and condition of appliances, and other things. The list is, of course, quite limited; but it should serve to give the students an idea of relative costs of various electricity uses.

** These estimates are rounded off to help students add costs. The 6¢/kWh charge approximates the average residential electricity cost in the Tennessee Valley.

Adapted from the TVA "Measure the Value" Energy Wheel, an educational product which is no longer available.

POCKET CHANGE GAME

Use a piece of posterboard to make the game board. Use envelopes for the "pockets," labelling each with the name of an electrical appliance. Glue or tape the pockets on the posterboard, leaving the top of each pocket open. Make the playing cards from construction paper, and make two or three for each item on the transparency. Write on each card the cost of operating the appliances (using the information on the transparency.) Place the cards in their pockets with the costs turned out of view. The students will choose appliances and draw the cards to see how much "pocket change" they will spend operating the chosen appliances. Have the students draw several cards each and add the costs of the cards.

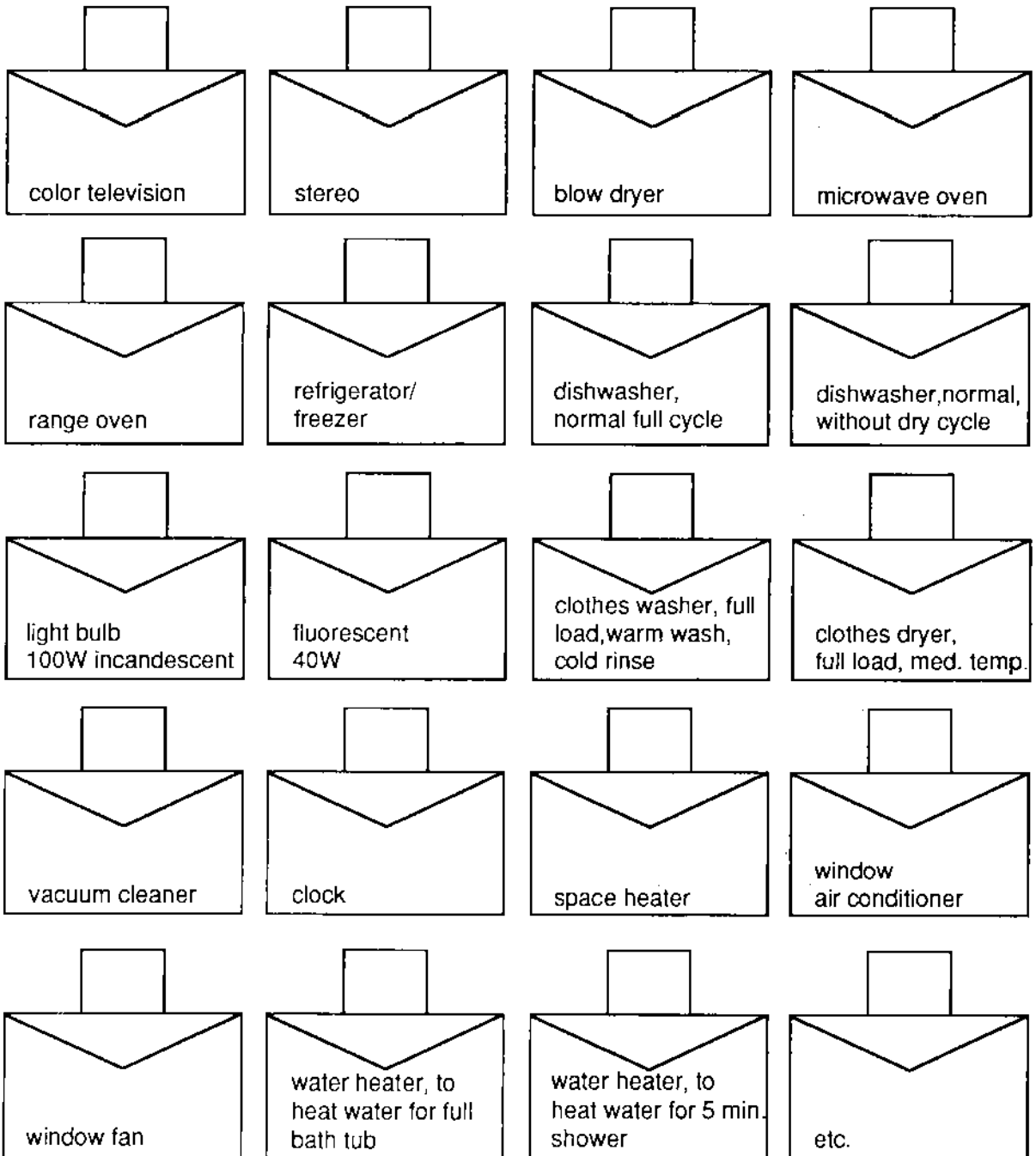

ATMOSPHERIC MONSTERS

OBJECTIVES

The student will do the following:

1. List the six major air pollutants.
2. Determine the amount and kind of particulates in their area.
3. State the major causes of air pollution.
4. State three ways to reduce air pollution.

SUBJECT:

Science

TIME:

120 minutes

MATERIALS:

dead tree branch, scissors, crayons or markers, string, sticks or dowels, coffee can, 4-ft-long wood pole, wood block (1.5 x 1.5 ft), white paper or cardboard, petroleum jelly, double-stick tape; student sheets (included)

BACKGROUND INFORMATION

There are six major air pollutants caused by the burning of coal, oil, wood, and other fuels. They are carbon monoxide, sulphur oxides, nitrogen oxides, ozone, lead, and particulates. These pollutants may cause harm to people, plants, and animals, as well as buildings and other manmade things. Some combine with water in the atmosphere to form acid rain.

Efforts are being made to install special air cleaners on factories, power plants, cars, and wood stoves to trap pollutants before they get into the air. Other efforts to reduce air pollution include encouraging people to use cars less and to conserve electricity. Using cars less and using less electricity will reduce the amount of fuel we burn, thus reducing the amounts of pollutants we put into the atmosphere.

Terms

acid rain: rainfall with a pH below normal (about 5.6); results from the reaction of sulfur oxide and/or nitrogen oxide pollutants with water vapor in the atmosphere.

carbon monoxide: a colorless, odorless, poisonous gas given off when vehicles burn fuel or when kerosene or wood stoves are operated.

lead: a pollutant released into the air by vehicles burning leaded gasoline.

nitrogen oxides: gases given off from vehicles and power plants; contribute to acid rain and ozone pollution.

ozone: a gas formed from nitrogen oxide pollutants in the presence of sunshine.

particulates: small pieces of dust, soot, or other matter that fall from the air.

pH: numerical scale measuring the acidity (how much like vinegar) or basicity (how much like ammonia) of a solution; ranges from 0 to 14, where 7 is neutral and values greater than 7 indicate basicity and less than 7 indicate acidity; normal pH for rainwater is 5.6.

pollutants: materials that make something impure or contaminated.

smog: smoke and fog trapped close to the earth's surface; caused by air pollutants being trapped in air masses over cities.

sulfur oxides: gases given off when power plants and factories burn coal for fuel.

PROCEDURE

I. Setting the stage

- A. Bring a dead tree branch into the classroom. Brainstorm with the students about what might have killed the tree (for example, old age, lack of water or sunlight, insects, disease).
- B. Introduce the idea that the tree might have died because of pollution in the air. Show examples of the six pollution monsters (prepared ahead of time from the student sheet "MONSTERS MOBILE" [included]). Hang them on the dead branch.

II. Activity

- A. Tell the students that the air—**atmosphere**—is necessary for plants, animals, and people to live. There is only a thin layer of air that we can breathe surrounding the earth; it is roughly comparable to the peeling on an apple. Natural air pollution has always existed because of volcanoes, forest fires, and other natural occurrences. Now there are so many people using so much fuel to produce electricity and other products and to power vehicles of all kinds, that the air pollution resulting from these activities is a serious problem.
 1. Introduce the term **pollutant**, and identify air pollutants as materials that dirty the air. Tell the students that most air pollutants come from burning coal, oil, wood, and other fuels. We use these fuels to run factories, our cars, and the power plants which generate the electricity we use to heat and light our homes.
 2. Give each student a set of the student sheets entitled "MONSTERS MOBILE," included. Allow the students time to cut out each monster.
 3. Present the following basic information on each of the six major air pollutants. You may wish to have the students list definitions or important facts on the back of each monster.
 - a. **Particulates** are bits of soot, dust, and other matter which fall from the sky. They are sent up into the air mostly by the burning of coal, diesel fuel, and wood. Particulates float back to earth and can cause people to cough, get sore throats, or have other breathing problems. They may even block the sun's rays so that temperatures and plant growth are affected.
 - b. **Carbon monoxide** is a colorless, odorless gas that gets into the air when vehicles burn fuel. It is also given off when kerosene or wood stoves are used to heat homes. Carbon monoxide causes people to have headaches, feel tired, or not think or move as quickly as they usually do; it may even cause death.
 - c. **Sulfur oxides** enter the air when power plants and factories burn coal for fuel. Sulfur dioxide is the main sulfur oxide pollutant. It can make breathing hard for some people and can hurt plants and trees. Sulfur dioxide reacts with oxygen in the air to become sulfur trioxide, which reacts with water in the air to form acid rain. Acid rain can slowly kill animals in lakes and rivers, and can also kill trees and other plants by damaging root systems. It can eat away at metal and stone on buildings and statues. Acid rain can occur hundreds of miles from the sources of sulfur oxides.

- d. Nitrogen oxides are "monsters" part of the time. They help plants to grow, but too much nitrogen oxide can cause trees to grow too late into the winter and be damaged by cold temperatures. Nitrogen oxides enter the air through exhaust from vehicles and some power plants. Breathing them can cause people to get sick. They may also combine with water to make acid rain or react with oxygen to produce ozone.
 - e. Ozone is formed when nitrogen oxides combine with oxygen in the presence of sunlight. If the air over a city does not move, smoke (exhaust) and fog become trapped close to the earth's surface, forming smog, and increasing ozone problems, which can lead to breathing problems for people. Too much ozone causes trees to grow more slowly and plants not to make as many seeds or fruits. Animals have trouble breathing in smoggy air, and they may not find enough food if plants have been harmed.
 - f. Lead was more of a problem a few years ago when all cars used gasoline with lead additives. When leaded gasoline is burned, lead is released into the air. As people or animals breathe lead, it accumulates in their bodies and can cause brain or kidney damage. Today most cars use unleaded gasoline, but there is still much leaded gasoline being sold, and lead continues to be a major pollutant, especially in cities.
4. Allow the students to color their monsters. Have them build mobiles by punching holes in the monsters, tying different lengths of string through the holes, and attaching a small stick or dowel.
 5. Ask the students for ideas on reducing air pollution. Tell the students that many factories, power plants, vehicles, and wood stoves have air cleaning devices that trap pollutants before they get into the air. Walking, riding bikes, sharing rides, and using mass transit reduces air pollution. Using less electricity reduces the fuel that power plants have to burn and thus reduces pollution.
- B. The Environmental Protection Agency estimates that 280 million tons of manmade waste products are released into the air each year in the United States. About a third of this is particulates, which fall back to the earth. Together with the students, do the following experiment to determine the amount and kind of particulates in your area.
1. Attach a wooden pole (approximately four feet long) to a wooden base measuring 1.5 by 1.5 feet. Punch a small hole in the bottom of a coffee can and, using a screw, attach the can to the top of the pole. The can's open end will face upward. The sides of the can and the height of the stand will help to keep out ground dust.
 2. Cut a disk to fit the bottom of the can from white cardboard or paper. Spread a thick coating of petroleum jelly over the disk. Lay the disk in the bottom of the coffee can, jelly side up.
 3. Place the stand in an open area on the school grounds. You may wish to put a few rocks on the base of the stand to keep it from blowing over.
 4. Check the disk in a few days to see how much particulate matter has fallen onto it.
 5. You may wish to repeat this procedure over a period of weeks, comparing the disk to determine which weeks had a heavier concentration of particulates. Why do some weeks have more fallout than others? (Investigate the production schedules of local factories; consider daily temperatures to see if people needed more heat from wood stoves; and so forth.)
- C. Change the experiment to see if more particulates are coming from one direction than another.
1. Use the coffee can on the pole from the previous experiment.

2. Using a compass, determine the directions and mark N, S, E, and W on the coffee can with a permanent marker.
3. Cover the outside of the can with double-stick tape. If the tape is not available, cover the outside of the can with white paper and apply petroleum jelly as before. (Be sure to mark the directions on the paper.)
4. With the students, check the can every few days to determine if the wind carries more particulates from one direction than another.
5. In the classroom, use a map to locate what big cities are located in the direction from which the most particulates are coming. You may be able to identify industries, power plants, and other potential contributors located in that direction.

III. Follow-up

- A. Have the students complete the "POLLUTION MONSTERS" student sheet (included).
- B. Have the students complete the "AIR POLLUTION EQUATIONS" student sheet (included).
- C. Have the students complete the "DO YOU HAVE A SOLUTION TO AIR POLLUTION?" student sheet (included).

IV. Extension

- A. Have the students write the Environmental Protection Agency to request information on the Clean Air Act.
- B. Have a representative from a local industry talk to the class about methods used by the industry to prevent air pollution.
- C. Have interested students research the killer smog in London in December 1952 which resulted in the deaths of over 4,000 people. (There were also other deadly air pollution episodes in London, as well as some in the United States.)

RESOURCES

Air Pollution Control Association. "Dictionary of Air Pollution Terms." (Address: P.O. Box 2861, Pittsburg, PA 15320.)

Duckworth, C. "The Big Bad Six." Ranger Rick, September 1987.

Keep America Beautiful, Inc. "Pollution Pointers for Elementary Students." (Address: 9 West Broad Street, Stamford, CT 06902, 203-323-8987.)

Motor Vehicle Manufacturers Association. "Saving Energy!" (stock no. 22). (Address: MVMA, ATTN: Communication Department, 300 New Center Building, Bartlesville, OK 74004.)

Schultz, R. F. "Solids in the Air." Environmental Experiments from Edison. Southfield, MI: Thomas Alva Edison Foundation, 1982.

Tennessee Energy Education Network. Call the Energy Hotline (toll-free) at 1-800-342-1340.

MONSTERS MOBILE

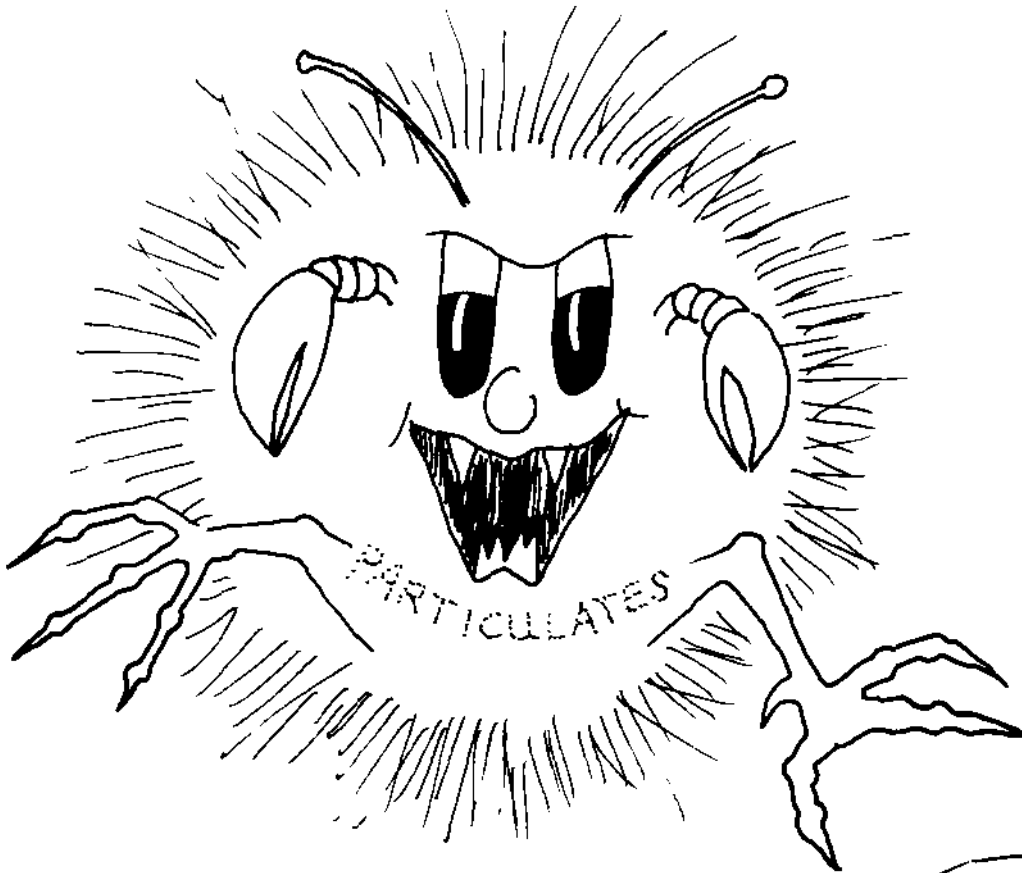

MONSTERS MOBILE
(continued)

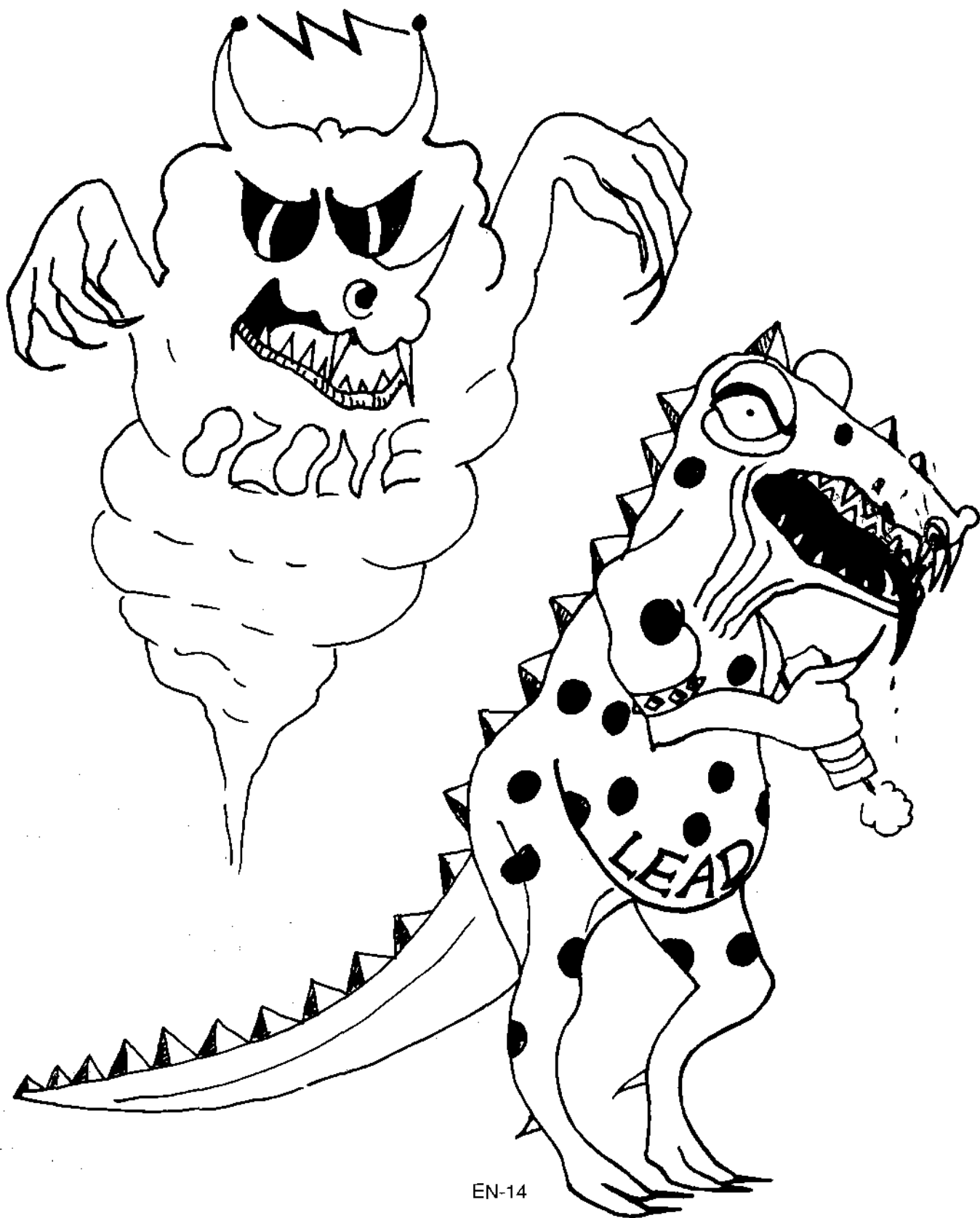

MONSTERS MOBILE
(continued)

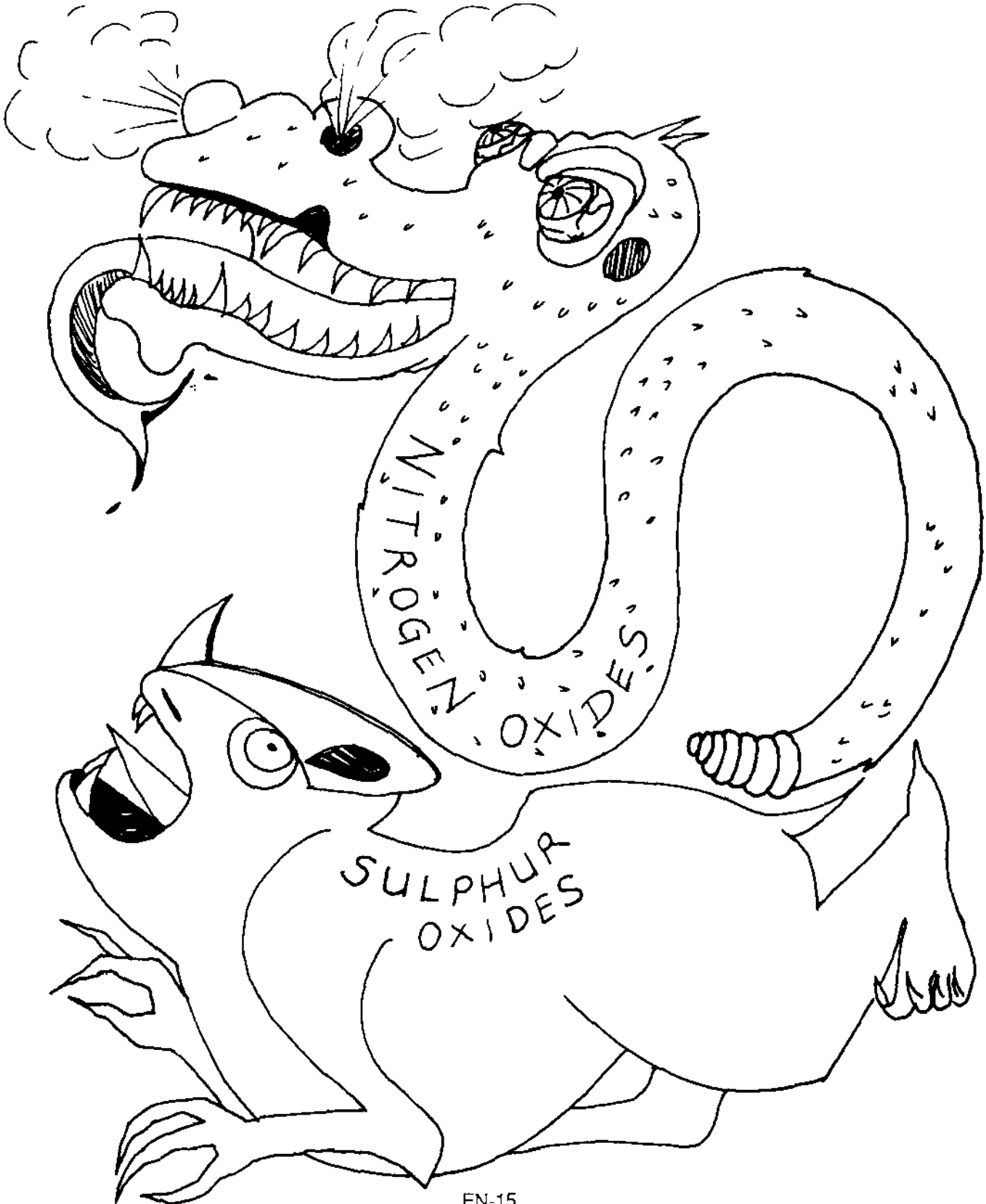

POLLUTION MONSTERS

Label each monster by writing the letter of its name in its box.

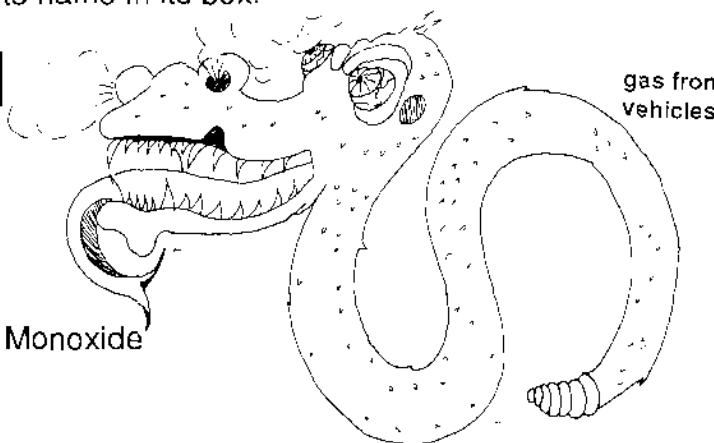

A. Carbon Monoxide

B. Lead

C. Nitrogen Oxide

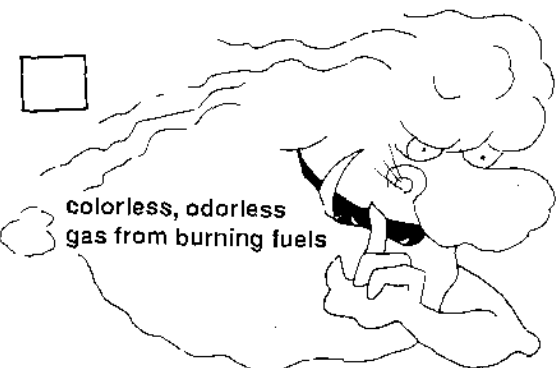

D. Ozone

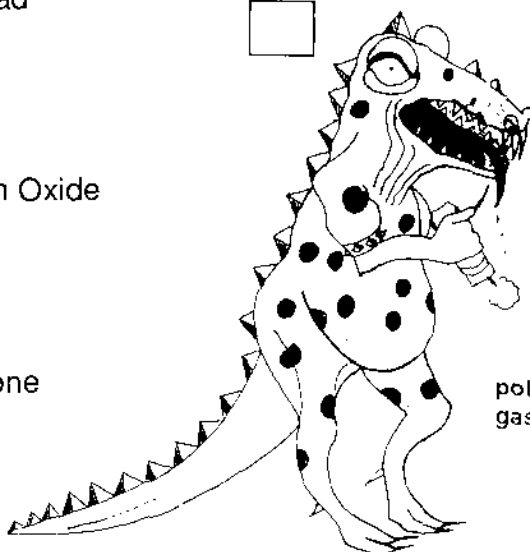

E. Particulates

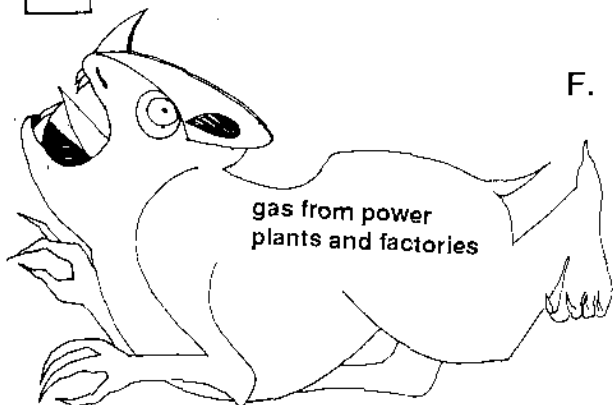

F. Sulfur Dioxide

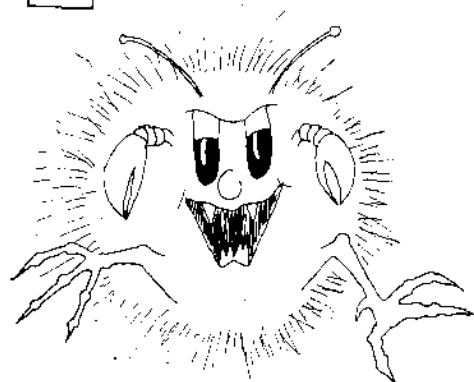

AIR POLLUTION EQUATIONS

Draw a picture illustrating a cause of air pollution in each box.

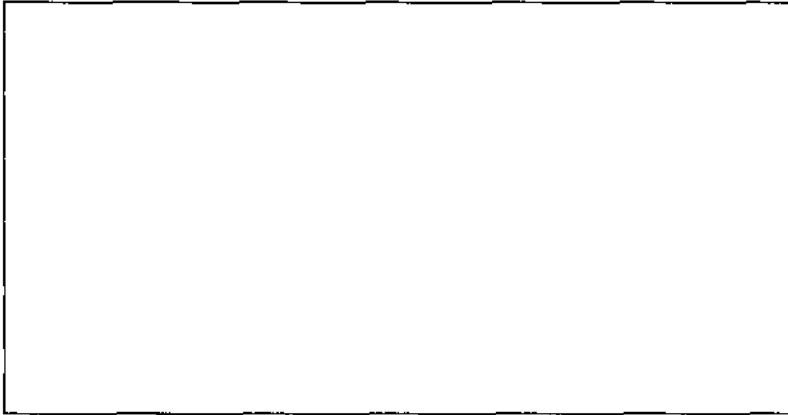

= AIR
POLLUTION

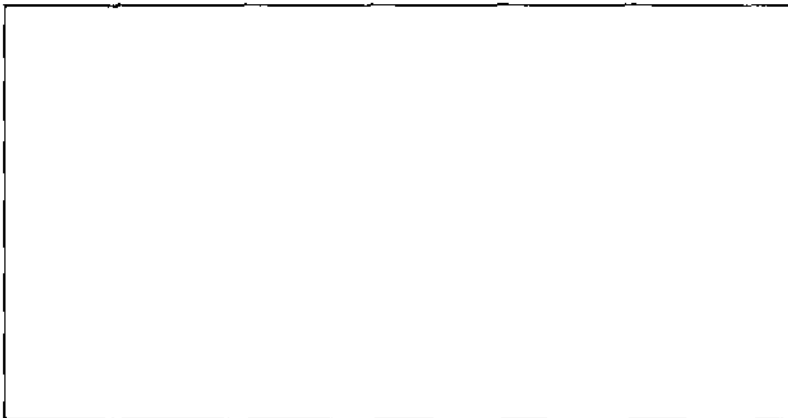

= AIR
POLLUTION

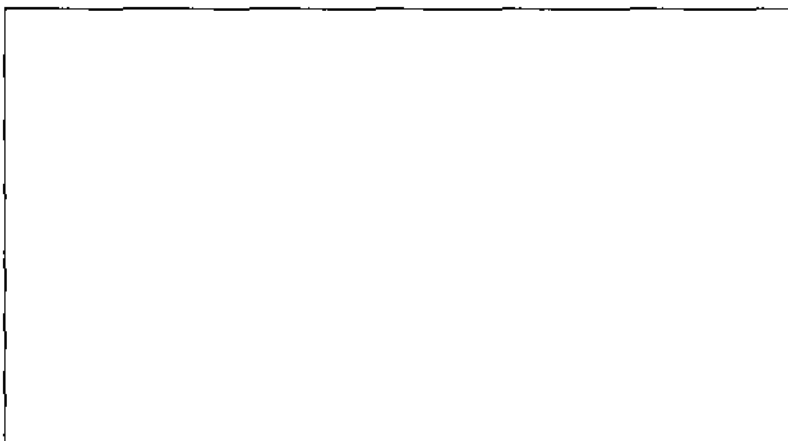

= AIR
POLLUTION

DO YOU HAVE A SOLUTION TO AIR POLLUTION?

Write your solutions on the clouds.

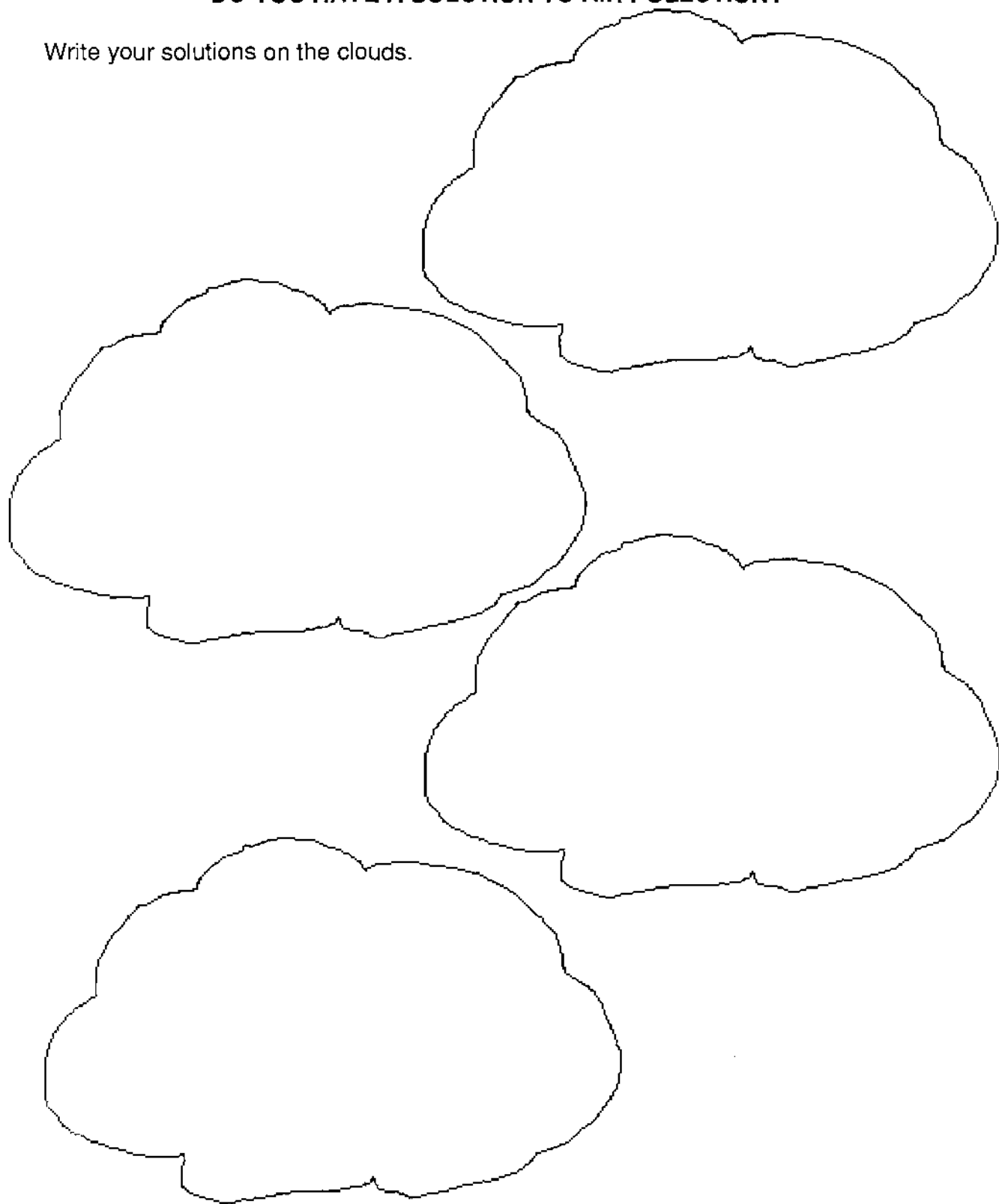

ACID RAIN—WHAT A PAIN!

OBJECTIVES

The student will do the following:

1. Define acid rain and identify two causes of acid rain.
2. Measure the pH (acidity and basicity) of various liquids.
3. Give examples of environmental problems caused by acid rain, and list possible solutions.

SUBJECT:

Science

TIME:

165 minutes

MATERIALS:

small cups, lemon juice, milk, litmus paper, ammonia, vinegar, orange juice, soft drink, milk of magnesia, pH paper, tweezers, tap water, distilled water, wide-mouth jars with lids, student sheets (included)

BACKGROUND INFORMATION

Water is used again and again as it is recycled in the environment. Time and time again the same water has fallen from the atmosphere upon the land, flowed into our streams and rivers and back to the sea, and returned to the atmosphere to fall again.

When factories and power plants burn coal, a kind of sulfur oxide gas is released into the atmosphere. This gas is changed by sunlight into a form that can react with water in the air to produce acid rain. Acid rain is also formed from nitrogen oxides released into the air from vehicles such as planes and cars and some power plants.

Acid rain has harmful effects on manmade things such as buildings and statues. The materials of which some of them are made are slowly dissolved by the acid in the rain. Acid rain is also very damaging to plant and animal life. Trees and crops can be stunted. Many lakes in the northeastern United States, Canada, and parts of Europe have no plant or animal life due to the effects of acid rain.

Terms

acid: any substance that turns litmus paper red; an acid has a pH of less than 7 (neutral).

acid rain: rainfall with a pH below normal (about 5.6); results from the combination of water with sulfur and nitrogen oxide air pollutants.

base: any substance that turns litmus paper blue; a base has a pH of greater than 7 (neutral).

litmus: a material used to test for acidity or basicity; contains chemicals that turn red when touched by an acid and blue when touched by a base.

neutral: any substance that is neither an acid nor a base; a neutral substance has a pH of 7.

nitrogen oxides: gases given off from vehicles and some power plants; contributors to acid rain and ozone pollution.

pH: a numerical scale measuring the acidity or basicity of a solution; scale ranges from 0 to 14, where 7 is neutral, acids have pH's of less than 7, and bases have pH's of greater than 7; normal pH for rainwater is about 5.6.

sulfur oxides: gases given off when power plants and factories burn coal; major contributors to acid rain; sulfur dioxide is the main sulfur by-product of burning coal.

water cycle: continuous cycle of water evaporating, condensing into a cloud, and falling back to the earth in some form of precipitation; recirculates water through the closed system of our planet.

PROCEDURE

I. Setting the stage

- A. Pass out copies of the student sheet "AIR POLLUTION," included. Ask the students what sources of air pollution they see in the picture (factories, vehicle exhaust).
- B. Point out that burning fuels causes much of our air pollution. Factories, homes, businesses, and institutions burn fuels such as coal, oil, and natural gas, which contain varying amounts of sulfur. (Coal is the chief source of sulfur pollutants.) This sulfur combines with oxygen when it burns to form sulfur dioxide gas. The gas is released in the smoke from chimneys and smokestacks. It is changed in the air to a similar gas that then causes a major pollution problem. Winds can carry this gas for hundreds of miles. Nitrogen oxides, gases given off from planes, cars, and some power plants, are also formed.
- C. Ask the students to look at the second panel. Do they think the rain washes the sulfur and nitrogen oxides out of the air, thus getting rid of them? Explain that the rainwater does wash the sulfur and nitrogen oxides out of the air, but instead of getting rid of them, the water combines with them to form acids. Acid rain is the result.
- D. Point out that the third panel shows warm air near the ground rising. (This is one source of wind.) This is the normal distribution of air temperatures—the layer of air near the ground is warmer than the air farther above the ground. Ask the students if they think this would help ease the air pollution problem. Explain that although wind helps relieve the problem right at that location, pollution does not disappear; it goes somewhere else. Winds carry the pollution elsewhere, spreading the problem.

II. Activity

- A. Tell the students that acid rain can kill fish and other wildlife. It can hurt the growth of new leaves or buds on plants. Acid rain even damages buildings, statues, and other objects by dissolving the materials of which they are made. The extent of acid rain's environmental damage depends upon both the acidity of the rain and the ability of the natural systems in a particular area to buffer (or neutralize) the acidity.
 1. Introduce the term pH, the measure of the acidity or basicity of a solution. pH is measured on a scale from 0 to 14, where 7 is neutral. Values below 7 are for acidity, and above 7, for basicity. Tell the students that the normal pH of rainwater is between 5 and 6. Any rainwater with a pH below that of normal rainwater is considered acid rain.
 2. Show the students the litmus paper. (Litmus paper and pH paper are available from science supply catalogs or aquarium shops.) Explain that it has chemicals in it that turn red when touched by an acid and blue when touched by a base.

3. Divide the students into groups and have them perform the following activities.
 - a. Give them small cups containing lemon juice. Then give them a piece of litmus paper. Have them dip one end of the litmus paper in the lemon juice, noting the color change. Have them generalize that lemon juice is an acid because the litmus paper turns red.
 - b. Next, give the students small plastic cups containing ammonia. Give them a second piece of litmus paper. Have them repeat the procedure and note that ammonia, which turns the litmus paper blue, is a base.
 - c. Give the students small cups of milk. Have them test the milk with litmus paper as before. There should be no color change with the milk, indicating that milk is neither an acid nor a base, but rather is neutral.
 4. Share with the students the following information (as appropriate to their levels of understanding).
 - a. All rainfall is slightly acidic, but rainfall in industrial areas is 30 to 40 times more acidic today than before the Industrial Age began. In fact, much of this increase has taken place over the past 30 years. Some rainfall in some industrial areas is very acidic. Wheeling, West Virginia, for example, has recorded rain more acidic than lemon juice.
 - b. Acid rain is absorbed by the roots of plants and harms their ability to absorb water and nutrients. It is especially harmful to evergreen trees. For example, much damage has been noted in West Germany's Black Forest. Similar damage can be seen at higher elevations of the Great Smoky Mountains in the eastern Tennessee Valley region.
 - c. Acid rain also affects lakes and streams. For example, many of the lakes in the Adirondack Mountains in New York have been severely affected. Acid rain kills water plants and affects the eggs of fish and other water animals. Many kinds of soil, such as those weathered from limestone (which is found in parts of our region) have the capacity to neutralize the acidity of acid rain. Partly because of this, the effects of acid rain have not been as severe in most of our region as in some other parts of the country. It is not known how long this buffering effect can last; we do know this natural buffering cannot handle severe acid rain. Also, because acid-forming pollutants can travel hundreds of miles from their sources in the winds, it is not possible to control where acid rain falls.
 5. Ask the students for ideas about preventing acid rain. Lead the students to realize that, if sulfur oxides are produced by the burning of fossil fuels to produce electricity, then any reduction in the use of electricity could result in less sulfur oxide production. Another way to reduce acid rain would be for power plants to burn coal that contains less sulfur. Some power plants are treating coal to remove the sulfur before burning it. There are also new ways of burning coal more cleanly. Many factories put devices called scrubbers in their smokestacks to remove the sulfur oxide gas before it enters the air. Scientists are trying to develop kinds of fish and crops that will not be damaged by acid rain. They are also trying to find ways of coating buildings, statues, and vehicles to protect them from acid rain.
- B. Have the students further explore acidity and basicity by performing the following investigation.
1. Have the student use small cups of vinegar, orange juice, a soft drink, and milk of magnesia, testing the liquids with litmus paper, as in the previous experiment. They are to determine which are acids (litmus turns red) and which are bases (litmus turns blue).

2. Introduce the use of pH paper, and have the students use the student sheet "pH SCALE" (included) to record the pH of each liquid. Remind the students that pH is measured on a scale of 0 to 14, with 7 on the scale representing a neutral solution. Anything measuring above 7 is considered basic, and anything measuring below 7 on the scale is considered acidic.
 3. Show the students a piece of pH paper and the pH color key card. Demonstrate how to dip a strip of pH paper into each sample tested earlier with the litmus paper. (Tweezers are helpful in handling pH paper.) Compare the color of the pH paper with the color key card. Record the pH of each sample on the student sheet by marking the scale and labelling each mark as to the sample having that pH.
 4. Remind the students that normal rainwater is slightly acidic, measuring about 5.6 on the pH scale. Have the students mark normal rainfall on the student sheet. Acid rain is considered to be any rain with a pH lower than normal. Which of the solutions they tested had pH's lower than 5? (vinegar, orange juice, soft drink) The city of Kane, Pennsylvania, has recorded rain as acidic as vinegar. Rainfall has been recorded in the Great Smoky Mountains that measured as acidic as soft drinks. Have them notice where each of these appears on the pH scale.
 5. Ask the students to watch for news or weather reports which give the pH of rainwater. How do different areas of the United States compare as to their rainfall acidity?
- C. Have the students determine the pH's of various water sources.
1. Using pH paper, test both tap water and distilled water. Have the students identify the pH of each by matching the paper's color to the key. Have them record the pH of each on the student sheet "pH SCALE—ACID RAIN," included.
 2. Remind the students that the normal pH of rainwater is about 5.6. Have the students mark this point on the scale.
 3. Divide the class into small groups and allow each group to pick a site at which to sample rainwater. Give each group a collection jar with a lid. Have the students wash the jars and lids and rinse them with distilled water. The jars are to be capped until the students are ready to use them.
 4. When it rains, allow the students to put their open, clean jars at their chosen sites. They should make sure the rain can fall directly into them. Setting the jars on pieces of plastic will keep ground contaminants out of the samples. When approximately one centimeter of water has been collected in the jars, they are to cap them tightly until they are ready to check the pH. Have the students note the direction of the wind before and during the rain.
 5. In the classroom, have each group drop a piece of pH paper into its collection jar. Have the students cap the jars and shake them for 60 seconds. The pH paper is then to be removed with tweezers and compared to the pH color key card. The pH of each group's rainwater should be marked and labelled on the student sheet.
 6. Have the groups compare readings from the different sites and answer questions such as these: Was your reading higher or lower than 5.6? If it was lower, what could be causing the acidity? If the readings were different for different sites, what could be the cause? From what direction was the wind blowing? What bearing might that have on the readings?

7. Discuss with the students the problem of acid rain in the Adirondack Mountains. Have them note the mean pH of the lakes in the 1930s and in 1975. Noting the pH reading where all fish are dead, ask the students what they think might be happening in the lakes now.
8. If you have obtained the poster "Acid Rain—The Effect on Aquatic Species" (available from the U.S. Fish and Wildlife Service), show it to the students. Discuss with them how acid rain affects various aquatic species.

III. Follow-up

- A. Have the students complete the puzzle on the student sheet "ACID RAIN," included.
- B. Have the students complete the student sheet "ACID OR BASE?," included. Make sure each student has both a blue and a red marker or crayon.
- C. Have the students complete the student sheet "PROBLEMS AND SOLUTIONS," included.

IV. Extension

- A. Students may design a bumper sticker to urge people to use fossil fuels wisely.
- B. Have interested students write reports on the damage done by acid rain to Germany's Black Forest.
- C. Some students may create an extended research project, monitoring the rainfall in your area over a period of time. Have them keep logs and note any changes in the rainwater's pH. What do they think could be causing these changes?

RESOURCES

The Acid Rain Foundation, Inc. (Address: 1630 Blackhawk Hills, St. Paul, MN 55122.)

Alexander, G. M., ed. "How Can Burning Be a Problem?" Science, Grade 5. Glenville, IL: Scott, Foresman, 1984.

Grove, N. "Air—An Atmosphere of Uncertainty." National Geographic, April 1987.

National Audubon Society. "Warning: Breathing in These Cities May be Hazardous to Your Health" (Brochure). (Address: National Audubon Society, Attention: Connie Mahan, 801 Pennsylvania Avenue, SE, Suite 301, Washington, D.C. 20003.)

National Wildlife Federation. "The Gentle Rain." The Class Project. Washington, D.C.: Author, 1982.

Postel, S. "Air Pollution, Acid Rain, and the Future of Forests." Washington, D.C.: Worldwatch Institute, 1984.

Sitwell, N. "Our Trees Are Dying." Science Digest, Sept. 1984.

U.S. Fish and Wildlife Service, Department of the Interior. "Acid Rain—The Effect on Aquatic Species" (Poster). (Address: Southeast Regional Office, Richard B. Russell Federal Building, 75 Spring Street, SW, Room 1200, Atlanta, GA 30303.)

U.S. Geological Survey. (Address: 419 National Center, Reston, VA 22092. Telephone: 703-648-4000.)

AIR POLLUTION

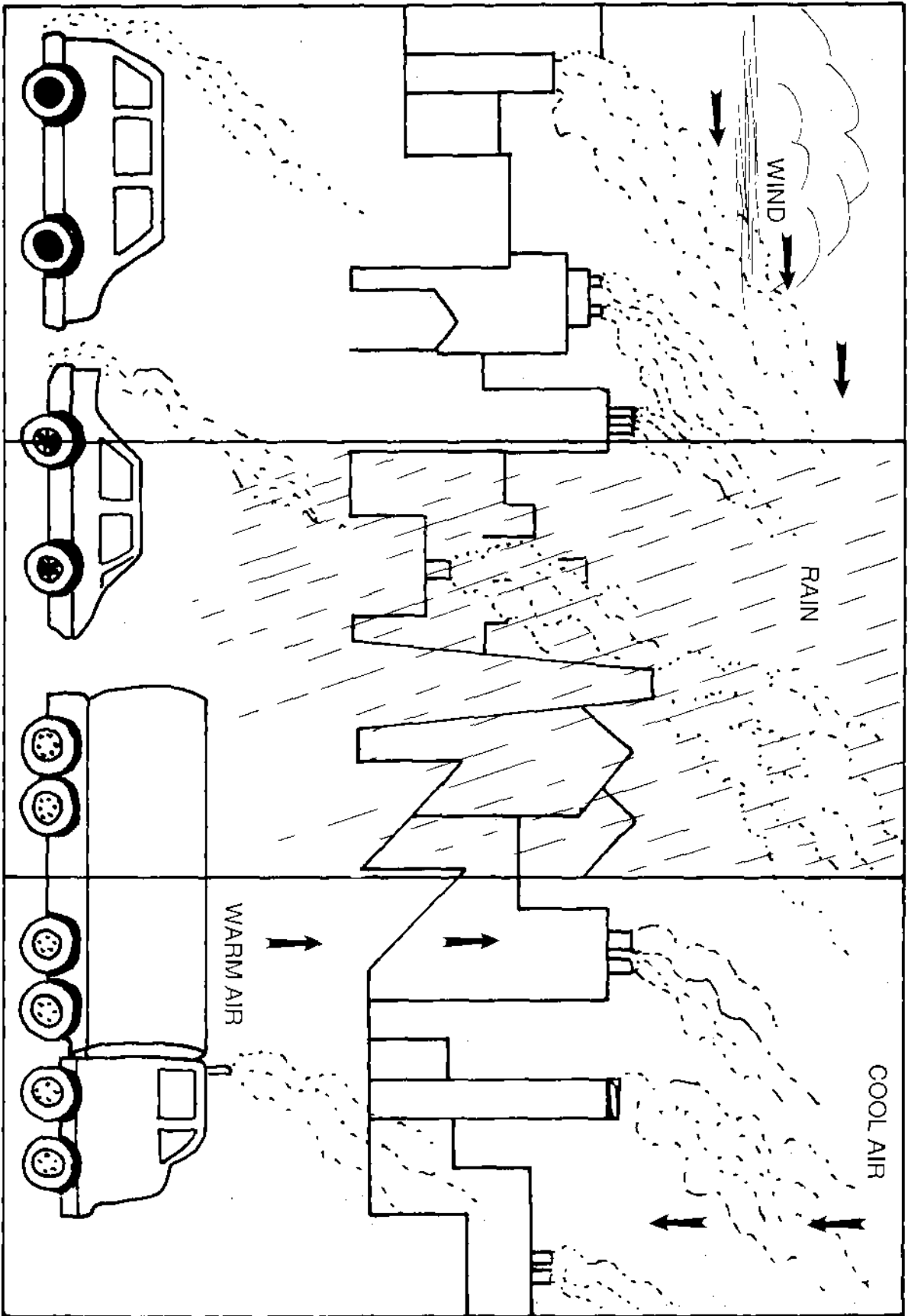

Student _____

pH SCALE

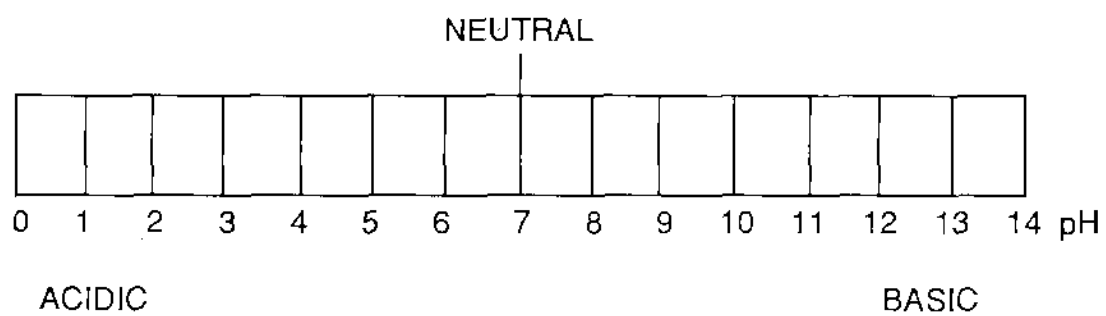

pH SCALE—ACID RAIN

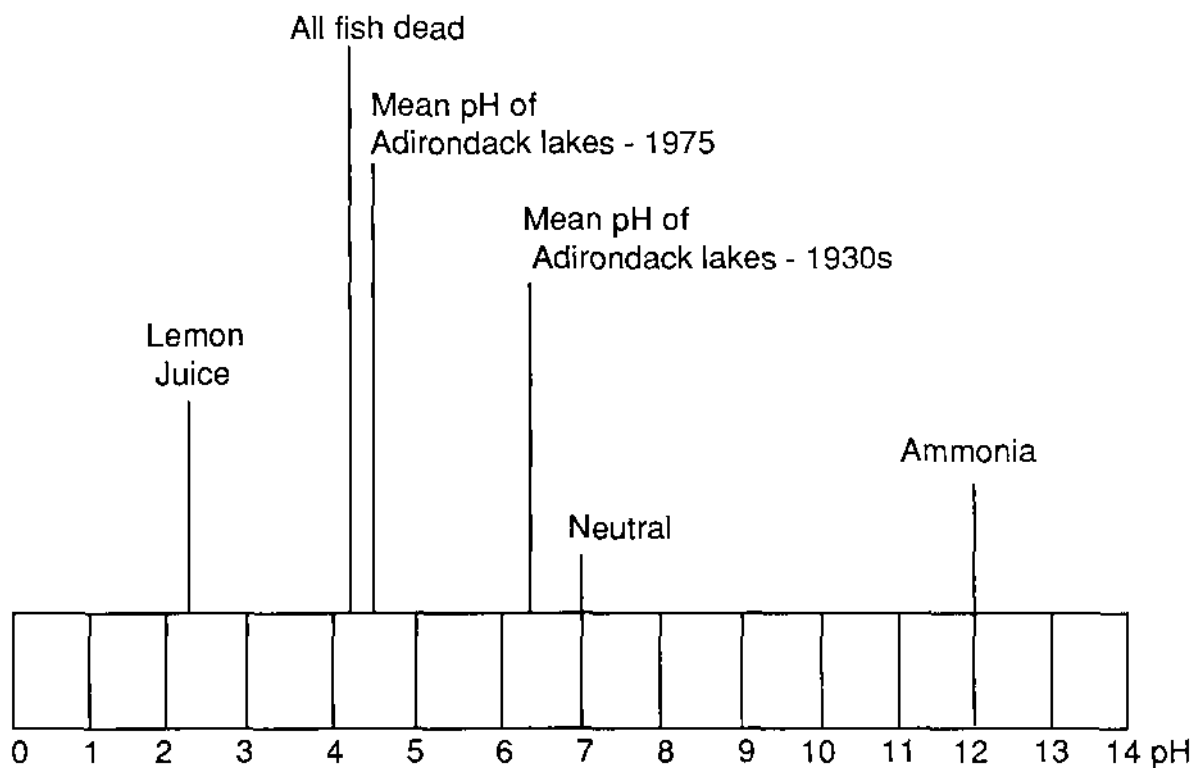

ACID RAIN

Fill in the puzzle. The clues below will help. They are in the correct order.

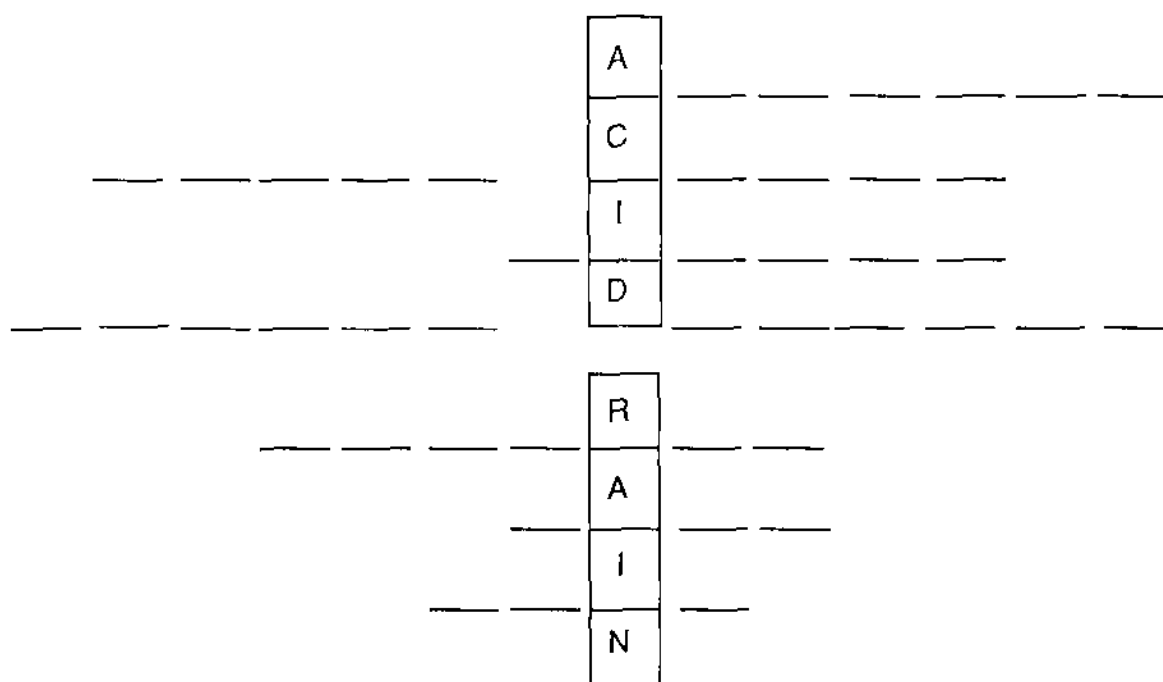

- A liquid that is a base; turns litmus paper blue.
- Continuous cycle of water; evaporating—condensing—precipitating. (2 words)
- Material that turns red when touched by an acid and blue when touched by a base.
- A gas that is given off when power plants and factories burn coal. (2 words)
- A liquid that is neither an acid nor a base.
- Any substance that turns litmus paper blue.
- Any substance that turns litmus paper red.
- A gas that is given off from planes, cars, and some power plants. (2 words)

ACID OR BASE?

Color the acids red and the bases blue.

Lemon
Juice

Milk of
Magnesia

Tap
Water

Milk

Ammonia

Orange
Juice

Cola

Vinegar

PROBLEMS AND SOLUTIONS

List an environmental problem caused by acid rain on each raindrop. List a possible solution for the problem of acid rain on each cloud.



THE WATER CYCLE—AGAIN AND AGAIN AND AGAIN

OBJECTIVES

The student will do the following:

1. Label the parts of the water cycle.
2. Observe demonstrations of a water cycle and the distillation process.
3. Explain how water may become polluted as people use it.

SUBJECT:

Science

TIME:

100 minutes

MATERIALS:

large jar with lid, small cup such as medicine cup, metric ruler, sunny window, tape, large pan or tub, a glass shorter than the pan's depth, 2 small clean rocks, clear plastic food wrap to cover the pan, masking tape, student sheets (included)

BACKGROUND INFORMATION

Although we usually take water for granted, people can live for only a few days without water. Nearly 70 percent of the earth's surface is covered with water, but only about one percent of all the water in the world is available fresh water. Most of the world's water is salt water, and most of its fresh water is frozen in glaciers and polar ice caps. Available fresh water is found in two places—on the surface of the earth in rivers, lakes, and streams and under the surface of the earth as groundwater.

The earth never gets any more water added to it. Through the water cycle, the same water that has been on earth for many thousands of years keeps circulating and recirculating. Today, each American uses about 570 liters of water daily (for personal, community, and industrial uses). This interrupts the water cycle by diverting a tremendous amount of water after it has fallen to earth and before it is recycled. While we use this water, we also usually pollute it; that is, every time we use water, it picks up pollutants from our use of it.

Terms

atmosphere: an envelope of air surrounding the earth.

condensation: the changing of water vapor to liquid.

evaporation: the changing of liquid water into water vapor.

groundwater: water found below the surface of the earth, stored underground in layers of rock.

infiltration: the process by which water seeps into the earth.

precipitation: forms of condensed water vapor that are heavy enough to fall to earth, such as snow, rain, and sleet.

surface water: water that can be seen above ground, such as that in lakes, rivers, and streams.

vapor: a substance in a gaseous state.

water cycle: the cycle in which water continually moves from the earth to the atmosphere and back again; the way water is recycled in the closed system of our planet.

PROCEDURE

I. Setting the stage

- A. Have the students list all the ways they use water in a day. Encourage them to include ways that water is used for them indirectly—in food preparation, manufacturing, farming, and other ways.
- B. Tell the students that the water they are using today has been on earth from the beginning. It is recycled continuously in the water cycle.

II. Activity

- A. Give the students the student sheet "RACEY RAINDROP'S JOURNEY," included.
 1. Read the story together with the students. Introduce and explain the new terms (evaporate, vapor, condensation, atmosphere, precipitation, infiltration, and water cycle).
 2. Have the students draw a picture of a simple water cycle, labelling the evaporation, condensation, and precipitation stages. The depiction may be one from Racey's journey or another of their own choosing.
- B. So that the students may observe the water cycle, perform the following demonstration.
 1. You will need a large jar with a lid, a small cup (like a medicine cup), a metric ruler, tape, and a sunny window.
 2. Fill the small cup with as much water as it can hold. Use the metric ruler to measure the height of the water in the cup. Record the water's height.
 3. Place the glass jar on its side in a sunny window. Tape the jar to the window sill so it does not roll. Carefully place the full cup of water inside the jar and near the jar's bottom. Close the lid on the jar tightly.
 4. Together with the students, observe the jar after 24 hours. How did the water droplets get on the inside of the jar? What has happened to the height of the water in the cup? (The height of the water in the cup has decreased. Water has evaporated from the cup and condensed on the inside of the glass jar.)
 5. Observe the jar again after 48 hours. Is there any water left in the cup? (All or most of the water from the cup will have evaporated and condensed onto the inside of the jar.)
 6. How does this demonstrate the water cycle? (The water evaporates from the cup, condenses inside the jar, and precipitates on the sides of the jar. It is a closed system, since nothing enters or leaves the closed jar. The water cycle operates similarly in a closed system—our planet.)

- C. In the story, "Racey Raindrop's Journey," Racey said he would be glad to evaporate and be clean again after being in polluted water. Do this demonstration to show the students how nature can clean water in the water cycle by a process called distillation.
1. Pour about 5 cm (2 inches) of muddy water into a pan. Put the pan in a place where the sun will shine on it all day.
 2. Sink an empty cup (right-side up) in the middle of the pan, holding it down with a small, clean rock.
 3. Cover the pan with clear plastic wrap, pulling it tight and taping it firmly to the pan (all the way around)
 4. Put another small, clean rock on top of the plastic wrap, centering it over the glass. Do not let the plastic wrap touch the glass.
 5. Watch what happens! During the day drops of clean water will form on the underside of the plastic wrap and drip into the glass.
 6. Explain to the students that as the sun heats the water, the water evaporates and turns into water vapor. When the vapor touches the cooler plastic wrap, it condenses back into water droplets, which drip into the glass. When the water vaporizes, the particles of mud are left behind; the water collected in the cup has very few impurities.

III. Follow-up

- A. Have the students complete the student sheet "WATER SCRAMBLE," included.
- B. Give the students the student sheet "THE WATER CYCLE," included. List the following terms on the board—evaporation, condensation, precipitation, groundwater, surface water. Have the students label the water cycle using these terms. (They may color the picture when they are finished.)
- C. Give each student a sheet of white paper. Have the students divide the paper into four sections. In each section, they are to write or illustrate a way that water may become polluted.

IV. Extension

- A. Make a terrarium to let the students observe the water cycle in action. Like the earth, a terrarium is a closed system. Once it is watered and closed, the water will circulate through the terrarium as a small-scale water cycle. Further watering of the terrarium should not be needed.
- B. As a class project, try to determine how much water is used by the school in a day. First, determine who uses the water (students, teachers, principal, custodian, secretary, cafeteria staff, bus drivers). Then determine how the water is used (drinking, washing dishes, flushing toilets, cleaning the school). Check a current water bill for the school's total usage and divide the amount shown by the number of days in the billing period. (Be sure to count only the school days in the billing period, subtracting the weekend days before dividing.)

RESOURCES

Alexander, G. M., ed. "How Can Burning Be a Problem?" Science, Grade 5. Glenville, IL: Scott, Foresman, 1984.

Elick, C. "Water." Tennessee Conservationist - Student Edition, January/February, 1988.

Garden Club of America. "The World Around You." Dayton, OH: The Mazer Corporation, n.d. (Address: Garden Club of America, 598 Madison Avenue, New York, NY 10022.)

Holmes, N. J., et. al. Gateways to Science, Grade 5. New York: Webster Division, McGraw-Hill, 1985.

Ontario Science Center. Scienceworks. Reading, MA: Addison-Wesley, 1984.

RACEY RAINDROP'S JOURNEY

Hi! My name is Racey Raindrop. My real name is H_2O , because I am made of two parts of hydrogen and one part oxygen; but my friends all call me Racey because I really get around! I have been going through this water cycle for thousands of years.

I've had some pretty fantastic adventures during this time. I was swallowed by a dinosaur once and was used another time to water a king's garden. Another favorite journey was when I landed on a pirate ship at sea. I have spent a lot of time in ordinary places too, like your playground or in your school's water fountain.

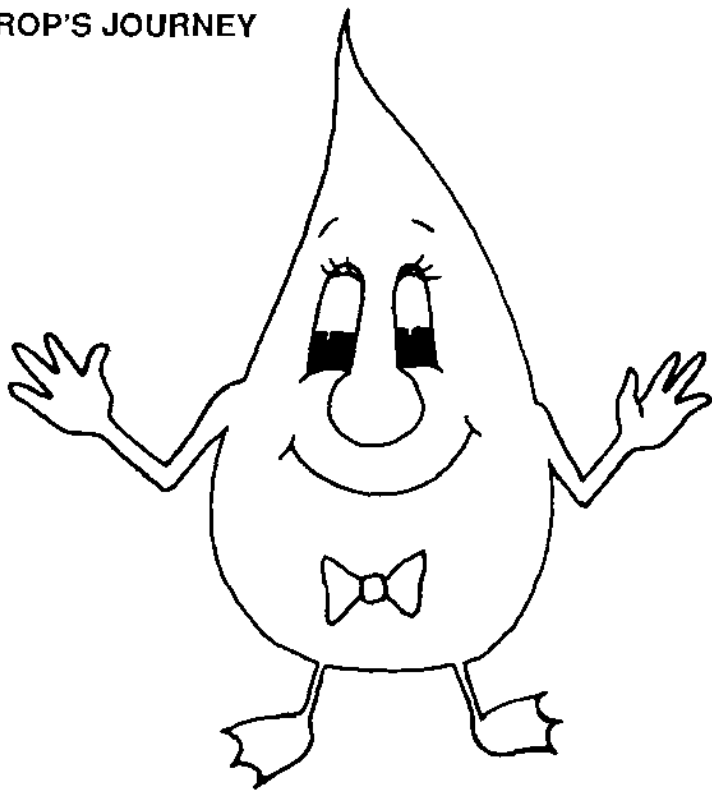

Are you wondering how I travel in the water cycle? It's like this! When I am on the earth's surface—on the ground or in a stream or ocean—and the warm sun shines on me, I evaporate and turn into a vapor. I rise on warm air currents high into the atmosphere, where I am cooled. When the atmosphere cools I condense back into a liquid. I turn into a tiny water droplet around a piece of dust or salt that is in the air, and when many, many others join me, we form a cloud. When the cloud gets too full and heavy, I fall back to the earth in some form of precipitation, like rain, snow, or sleet. Then I either stay on the surface of the earth, maybe in a stream or pond, or I soak down into the ground and join the groundwater supply. Soaking down into the ground is called infiltration.

It's fun being a snowflake and getting made into snowballs, or being heated and turned into steam to make electricity. But my job isn't always fun. Sometimes I get caught over a city and become polluted in the dirty air. When I fall back to the earth I carry this pollution as acid rain. Sometimes I fall into a pond that contains pesticides used by farmers to control insects and weeds. Some of these chemicals are not good for you, if I find my way into your drinking water supply while I'm carrying them. I'm always glad to evaporate and get cleaned up after that situation!

Remember, nothing can live without me! So be careful with me—don't waste me! Don't pollute me! Oops! Gotta go! Some children down there need me in their swimming hole!

WATER SCRAMBLE

Unscramble each word and fill in the blanks. Use the words in the word bank.

1. _____ is the changing of liquid water into water vapor.
(NAAVEITORPO)
2. _____ is a substance in a gaseous state.
(ROPVA)
3. _____ is the changing of water vapor to a liquid.
(DANNNCTOOSEI)
4. _____ is an envelope of air surrounding the earth.
(SOHAMTEEPR)
5. _____ is the forms of condensed water vapor, such as snow, rain, and sleet.
(TPTIIIEACRPNO)
6. _____ is the process by which water seeps into the earth.
(RATITLIFNNIO)
7. _____ is the cycle in which water continually moves from the earth to the atmosphere and back again.
(AETRW YCCLE)

| WORD BANK | |
|--------------|---------------|
| ATMOSPHERE | INFILTRATION |
| CONDENSATION | PRECIPITATION |
| EVAPORATION | WATER CYCLE |
| VAPOR | |

THE WATER CYCLE

Label the parts of the water cycle.

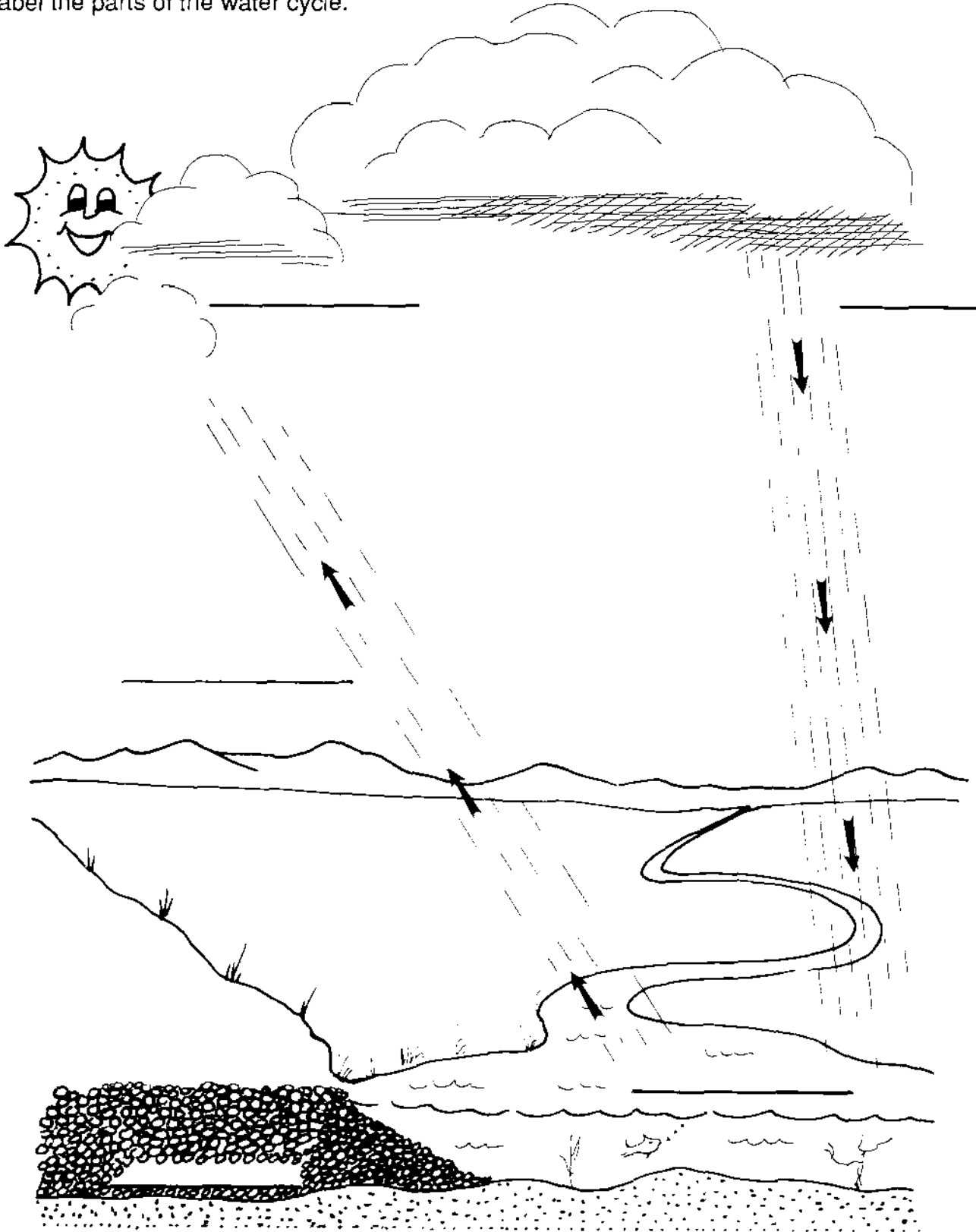

ALL WASHED UP

OBJECTIVES

The student will do the following:

1. State the major causes of water pollution.
2. Conduct an experiment to investigate the effects of an oil spill on wildlife.
3. Give solutions for reducing water pollution.

SUBJECT:

Science

TIME:

120 minutes

MATERIALS:

4-liter glass jar, blue food coloring, 10 baby food jars, labels, water, clock with second hand, natural feathers, vegetable oil, hand lens, paper towels, liquid detergent; student sheet (included)

BACKGROUND INFORMATION

No new water is ever added to the earth. Through the water cycle, the same water that has been on the planet for many thousands of years keeps circulating and recirculating. People interrupt the water cycle by using the water after it falls to earth. Worse, while they use it, they usually pollute it.

Our drinking water is being contaminated by pesticides and other chemicals, improperly treated sewage, and industrial wastes. Acid rain caused by emissions from factories, power plants, and vehicles is damaging the environment. Groundwater supplies are being contaminated and are being depleted faster than nature can replenish them. Many natural wetlands have been filled and developed, contributing to erosion, flooding, and loss of habitat for plant and animal species.

The process of treating polluted water so that it may be used for drinking water is very expensive. Our lifestyles and ever-increasing consumption of energy are contributing to our increasing water pollution problems. Conservation practices are necessary to keep our water sources usable.

Terms

dilute: to make weaker (less concentrated) by adding water.

groundwater: water found below the surface of the earth; stored underground in layers of rock.

pollution: materials that make something impure or contaminated.

sewage: wastewater containing human waste.

thermal pollution: the addition of heated water to a body of water (such as a lake or stream).

PROCEDURE

I. Setting the stage

- A. Together with the students, make a list of all the water sources in your area (include lakes, rivers, creeks, reservoirs, oceans, springs, wells, rain, puddles, etc.). Ask them from which sources they would like to drink. In which sources would they like to swim?
- B. Next, rank the sources from the cleanest water to the dirtiest water. Discuss what makes some of the water dirty—natural sources (leaves, twigs, eroded soil) and manmade sources (litter, chemicals, and other wastes). Ask the students if all the water sources that look clean are safe to drink. (No; some pollutants are not visible.)
- C. Tell the students that each person in the United States uses about 570 liters of water each day. About 380 liters of this water are used by agriculture and industries to make the products we need, and the other 190 liters are used personally (bathing, cleaning, flushing toilets, and so on).

Ask the students what they add to the water while it is in their homes (soap, toothpaste, shampoo, bleach, detergent, fertilizers, insect sprays, human wastes, and so on). In addition, farmers use chemicals to help crops grow and to kill weeds and insects. Rain and melting snow wash these chemicals into lakes and streams. Factories make many products from chemicals; cars run on chemicals made from oil; and medicines and clothes come from chemicals. In the past, factories dumped many of the waste products from these chemicals into lakes and streams.

Point out that people used to think that, because rivers and lakes held large amounts of water, they could clean themselves. They thought the water would weaken or dilute the pollutants and make them harmless. We now know that even a little pollution can damage a large body of water and that rivers and lakes cannot clean themselves as fast as people pollute them. This water must be cleaned before it can be used again.

II. Activity

- A. Do the following demonstration to show how a small amount of pollution can affect a large amount of water.
 1. Fill a 4-liter jar with water. Add a single drop of blue food coloring to the water. The food coloring represents pollution in the water source. Point out to the students how the blue color diffuses throughout the water.
 2. Add 30 drops of blue food coloring. Ask the students to predict how much clear water would have to be added to dilute the blue pollutant completely.
 3. Have 10 small baby food jars numbered from 1-10. Fill jars 1 and 2 half-full with the colored water. Jar 1 will remain the control jar for comparisons.
 4. Add clean water to jar 2 until it is full. Now compare the color of jar 2 with that of jar 1.
 5. Pour half of the water from jar 2 into jar 3. Add clean water to jar 3 until it is full. Ask the students what changes in the color of the water take place.
 6. Continue in this manner, successively pouring half of the colored water from each of the jars 3-9 and filling jars 4-10 successively with clear water. Have the students observe the color of the water in each jar.

7. Ask the students if the water in jar 10 is completely clear. Put a white card behind the jar so that any bluish tint remaining can be more easily seen. (Some food coloring is still in the water. You might allow this water to evaporate and have the students look for colored particles with a hand lens.)
 8. Ask the students if, considering this demonstration, they think dilution is a good way to reduce water pollution.
 9. Tell the students that many state and local governments have passed laws to stop people from dumping pollutants into lakes and streams. Many factories are building their own wastewater treatment plants. Many states have banned the manufacture and sale of chemicals that have polluted our water. Some chemical companies are developing new chemicals that cause less pollution.
 10. Explain that chemicals used for farming cannot be easily removed from water supplies. Some farmers are reducing some types of chemical pollution by using natural fertilizers like manure or compost. Some farmers are using natural enemies of insect pests, such as wasps and ladybird beetles, instead of spraying fields with chemicals.
- B. Tell the students that another kind of water pollution is thermal pollution or heat pollution. Many factories use water to make products people need or to cool their machines. Power plants produce large amounts of heat in the production of electricity. These power plants also need water to cool their machines. They take in cool water and pump out heated water. If this water is not cooled before being pumped back into lakes and streams, the added heat can harm many plants and animals. Do this activity to show the students how thermal water pollution can affect water animals.
1. Point out that all living things are sensitive to temperature changes. Brainstorm about how animals adapt to specific climates (cold—hibernate, thick fur, live at the bottom of ponds or lakes; hot—less active, thin fur, live close to water).
 2. Tell the students that fish are sensitive to temperature changes. Heated water raises their body temperatures and speeds up all their body functions, including their need for food and oxygen. It also causes them to mature faster and die earlier. If fish hatch too early in the year, there may not be enough food for them to survive. Also, an increase in the water temperature reduces the amount of oxygen in the water and can cause fish to suffocate. The warmer the water, the less oxygen it is capable of holding.
 3. Ask the students to count and record the number of breaths they take in one minute. (Tell them to count each time they breathe in.) Next, have the students breathe the same number of times in a two-minute period rather than in one minute. To do this, they will have to lengthen the intervals between breaths. Try the activity over a three-minute period. (CAUTION: Students with breathing problems should not do this activity.) Explain to the students that this is similar to what happens to some kinds of fish in thermally polluted water.
 4. Tell the students that thermal pollution also kills many water plants that fish depend on for food. Other plants, such as algae, grow faster and may cover the entire surface of the water, thus depriving the other plants and animals of oxygen and sunlight.
 5. Tell the students that some power plants and factories use cooling towers to avoid thermal pollution. The warm water stays in the tower until it cools to a temperature near that of the lake or stream, and then it is released. Some factories use ponds to cool water.

- C. Oil spills from offshore wells and tanker accidents are another cause of water pollution. Have the students do this experiment to investigate the effects of oil spills on wildlife.
1. Give each student a feather and a hand lens. Have the students observe the feather carefully, using the hand lens to see how each barb of the feather is separated from the others.
 2. Have each student put drops of water on his/her feather and observe the effects of the water. (The barbs will be joined by the water.) Have the students dry the feathers by waving them in the air. They are to observe the feathers again after they dry, noting that the barbs are separated.
 3. Next, have the students dip the feathers into vegetable oil and wipe off the excess oil with a paper towel. Have them try to dry the feathers by waving them in the air. Can the students get the feathers back to the dry state?
 4. Have the students clean the feathers in liquid detergent, rinse them in water, and dry them. They are then to examine the feathers again with the hand lenses. What changes have taken place? Point out that while the detergent does remove the oil, it also removes the bird's natural oils. If the birds are released back into the wild before these natural oils are replaced, the birds may drown because their feathers are not waterproof. The birds are also more susceptible to disease during this time.
 5. Tell the students that oily water can poison plants and animals. It covers some plants and animals and keeps them from getting food or oxygen. In the case of birds, the oil can prevent them from flying or swimming. The oil might cover food sources. Swallowing some of the oil can poison animals. Additionally, oil can seep through the eggshells of nesting birds, killing the chicks. Fish often suffocate when oil clogs their gills.
 6. Tell the students that, as with all forms of pollution, the best solution to the problem of oil spills is to prevent them from happening. Conservation measures will relieve the strain of having to produce more and more oil.
- D. Brainstorm with the students other conservation measures concerning the use of water and household pollutants. Some examples of conservation measures follow:
1. Don't use a water freshener in your toilet bowl. It pollutes the water with perfumes and dyes.
 2. Try to use less detergent and shampoo.
 3. Never pour paint, turpentine, or garden sprays down the drain.
 4. Cut back on the use of bleach and scouring powders.
 5. Avoid spraying pesticides like insect and weed killers around the home and garden.

III. Follow-up

- A. Have the students complete the student sheet "WATER POLLUTION," included.
- B. Have the students write a story (from a fish's point of view) describing his/her life in thermally polluted water.

- C. Have the students identify how an oil spill would affect each of the following:
1. Birds (May prevent them from flying or swimming, and may destroy food sources.)
 2. Eggs (Oil might seep through the shells, killing the chicks, turtles, or other animals.)
 3. Fish (Suffocate when oil clogs their gills.)
 4. Plants (Oil coats plants, preventing them from getting sunlight or air.)
- D. Have the students identify three solutions for reducing water pollution. (Accept all reasonable answers.)

IV. Extension

- A. Look into the effects of spilled oil on bird eggs. Put used motor oil in a small container. Hardboil three eggs and drop them into the oil. Check one egg after five minutes, one after fifteen minutes, and one after thirty minutes. To check each egg, peel off the shell and note whether the motor oil has penetrated the shell. Discuss with the students the implications of an oil spill for the eggs of birds nesting near the water where there has been a spill.
- B. Have each student imagine that he/she is the mayor of a city which adjoins a polluted lake. He/she has made a campaign promise to clean up the lake. How would he/she do this? (You might suggest that, first, they find the source of the pollution. Then they may plan ways to slow the pollution down and/or suggest ways to clean up the lake.)
- C. Have the students investigate three methods of removing oil from the surface of the water after an oil spill (burning the oil, spraying chemicals on the oil to break it up, and surrounding it with a floating collar and then pumping it from the surface of the water into barges).

RESOURCES

Alexander, G. M., et. al. Science, Grade 5. Glenville, IL: Scott, Foresman, 1984.

Elick, C. "Water." Tennessee Conservationist - Student Edition, January/February, 1988.

Garden Club of America. "The World Around You." Dayton, OH: The Mazer Corporation, n.d. (Address: Garden Club of America, 598 Madison Avenue, New York, NY 10022.)

Holmes, N. J., et. al. Gateways to Science, Grade 5. New York: Webster Division, McGraw-Hill, 1985.

Western Regional Environmental Education Council. "No Water Off a Duck's Back." Project Wild. Boulder, CO: Author, 1983.

WATER POLLUTION

Water pollution can come from homes, industries, and even natural sources. For each kind of source, put one cause of water pollution in each box. Draw and color pictures to illustrate the causes.

| | | | |
|--------------------------------------|--|--|--|
| N A T U R A L | | | |
| H O M E | | | |
| I N D U S T R Y | | | |

DOWN THE DRAIN—NEVER!

OBJECTIVES

The student will do the following:

1. Name three hazardous wastes and their sources.
2. State special problems associated with the disposal of hazardous wastes.
3. Describe what is being done to solve the problem of chemical pollution.

SUBJECT:

Science

TIME:

105 minutes

MATERIALS:

food coloring, clear drinking glass, paper cup (3-oz size), plastic sandwich bag, watering can with water, 2 large pans, soil, packet of cherry drink mix, medicine dropper, white paper, Twinkie or cream-filled cupcake, teaspoon of chopped onion, plastic wrap, knife; student sheets (included)

BACKGROUND INFORMATION

While most wastes from homes can be disposed of by burning or burying them, chemical wastes (for example, those from factories) pose special disposal problems. These wastes may be poisonous or may burn easily. In addition, hazardous wastes from military bases (explosives), from hospitals (disease-carrying wastes), from laboratories (poisonous chemicals), from gasoline stations (waste oil and antifreeze), from power plants (ash), and from nuclear power plants (radioactive wastes) must be disposed of in special ways to prevent contamination of the soil and groundwater supplies.

Some wastes may be buried in specially designed containers that resist leaking. Some wastes may be used to make something else; for example, some power plant ash can be used as fertilizer or used to make cement. Scientists and the government are looking for safe places to dispose of military, medical, and radioactive power plant wastes. The best solution for hazardous waste disposal problems is to produce less waste; this is also being investigated.

Terms

groundwater: water that seeps down into the earth to be stored in rocks underground; the source of water from wells and springs.

hazardous substance: material that presents a danger to health or the environment.

radiation: energy given off by atoms undergoing nuclear decay (changes in their nuclei).

PROCEDURE

I. Setting the stage

- A. Review the water cycle with the students. Introduce the term groundwater (see "Terms"). Tell the students that about half the drinking water in the United States comes from wells and springs supplied by groundwater. In rural areas, almost everyone depends upon groundwater.
- B. Have the students pretend they work at a factory that makes bicycles. As a final step in the manufacturing process, the bicycles are painted. The extra paint must be disposed of. The paint is poisonous, so it is considered to be a hazardous substance. Tell the students that special care must be taken in disposing of hazardous substances. Have the students suggest ways to get rid of the leftover paint.

II. Activity

- A. The students will probably suggest that the old paint could be poured down the drain, thrown in the garbage, or buried. Do the following demonstration to explore some possible methods of hazardous waste disposal.
 1. Hold up a clear glass filled with water. Tell the students that this represents groundwater from which we get our drinking water. The food coloring will represent the old paint that must be disposed of.
 2. Add a few drops of food coloring into the water. What happens? (The food coloring spreads out into the water.) Add a little more food coloring. How long does it take for the whole glass of water to become colored?
 3. Remind the students that the bicycle paint is harmful if swallowed. Could there be any danger to our drinking water supplies if the paint is poured down the drain?
 4. If the students suggest burying the paint, ask if it should be buried in any special container. Put a little food coloring in a paper cup (3-oz size, no wax coating). Let it sit on a table for a few minutes. What happens? (The food coloring will leak through the sides and bottom of the paper cup.) Could this be a problem for the soil and groundwater? (Yes; hazardous substances could leak out of the containers and enter the groundwater.)
 5. Repeat the procedure for step 4 above, this time putting a little food coloring in a plastic sandwich bag. Let it sit on the table for a few minutes. Does the food coloring leak through the plastic bag? (no) Would there be any danger to the surrounding soil and groundwater? (no)
 6. Tell the students that legal landfill sites must have a liner made of clay, rubber, or a certified synthetic material. They also must have monitoring wells so that the groundwater can be tested to be sure no hazardous substances are leaking out into the groundwater.
- B. There are six major sources of hazardous substances. These are military bases (which must dispose of explosives), hospitals (disease-carrying wastes), laboratories (poisonous chemicals), gasoline stations (used oil and antifreeze), power plants (ash), and nuclear power plants (radioactive wastes). Do this demonstration to further explore how improper disposal of these wastes can cause problems for groundwater supplies.
 1. Fill two large pans (e.g., jellyroll pans) with soil. Mound the soil slightly in the middle of each pan. Hollow out a small depression in one mound and pour the packet of drink mix into the soil. Cover it with a layer of soil. This represents a hazardous substance being buried.

2. First, sprinkle water on the pan of soil without the drink mix. Saturate the soil until some water is collecting in the corners of the pan. Using the medicine dropper, sample this "groundwater." Put a drop of this water on a piece of white paper. Keep this for comparison with the next sample.
 3. Next, sprinkle water on the pan that contains the drink mix. Saturate the soil as before and sample the water that collects in the corners of the pan. Put a drop of this water next to the first drop on the white paper. Is there a difference in the color of the water? (The water will be colored from the drink mix.) Has the "hazardous substance" entered the groundwater? (yes)
 4. Tell the students that many hazardous chemicals used to be disposed of in large metal drums. After a few years many of these drums started leaking and their chemicals polluted the soil and groundwater.
 5. Caution the students that, if they find such drums, they should not play near them and they should tell an adult about them immediately.
- C. The disposal of radioactive wastes from nuclear power plants presents a particular problem. Currently they are being stored temporarily at the power plants while scientists are trying to find the best way to dispose of these materials. Eventually they may be buried in thick layers of granite rock, in underground salt mines, or under ocean basins. The wastes may remain radioactive for thousand of years. Do the following demonstration to see how radioactive material may contaminate soil and groundwater.
1. Use a Twinkie or cream-filled cupcake to represent the earth (the cream filling will represent the groundwater supply).
 2. Carefully cut a piece out of the middle of the cake and put a teaspoon of chopped onion (representing radioactive material) on the exposed cream filling. Cover the onion with the piece of cake that was removed. Tightly seal the cake in plastic wrap. Let the experiment sit for a day.
 3. Remove the plastic wrap and cut a section from the edge of the cake. Have the students smell the section. Can the odor of the onion be detected in the cream filling (groundwater)? The onion pieces did not move through the cream filling. How did the odor get to the edges of the cake? (The strong smell permeated the cream filling, much as radiation could leak from improperly stored waste materials.)
 4. Tell the students that much debate is currently going on about where to locate nuclear waste disposal sites. Have the students debate this issue: If one state creates the waste, should that state be responsible for storing it, or should the disposal sites be a national decision?

III. Follow-up

- A. Have the students draw a diagram of a landfill that is considered legal and safe. Have them label the diagram. (Check the diagram for a liner and a monitoring well.)
- B. The students are to complete the student sheet "MATCH THE WASTES AND THEIR SOURCES," included.
- C. The students are to complete the student sheet "WHAT CAN BE DONE?," included. Have them choose two hazardous waste problems and give a solution for each of the problems. They may write a paragraph or draw a picture.

IV. Extension

- A. Find out about the problems created when a school and houses were built near a chemical waste dump at Love Canal in Niagra Falls, New York.
- B. Write the Environmental Protection Agency for the most recent information on the disposal of hazardous wastes.

RESOURCES

Alexander, G. M., et. al. Science, Grade 5. Glenville, IL: Scott, Foresman, 1984.

American Institute of Professional Geologists. "Groundwater: Issues and Answers." (Address: 7828 Vance Drive, Arvada, CO 80003. Telephone: (303) 431-0831. Cost: \$3.)

Holmes, N. J., et. al. Gateways to Science, Grade 5. New York: Webster Division, McGraw-Hill, 1985.

Tennessee Energy Education Network. "Nuclear Energy" (materials packet). (Address: Sixth Floor, 320 Sixth Avenue, North, Nashville, TN 37219-5308, ATTN: Ms. Dawson. Telephone: 1-800-342-1340.)

MATCH THE WASTES AND THEIR SOURCES

Match the hazardous wastes to the sources.

SOURCES

1. MILITARY BASES
2. HOSPITALS
3. LABORATORIES
4. GASOLINE STATIONS
5. POWER PLANTS
6. NUCLEAR POWER PLANTS

HAZARDOUS WASTES

- A. POISONOUS CHEMICALS
- B. ASH
- C. DISEASE-CARRYING WASTES
- D. EXPLOSIVES
- E. RADIOACTIVE WASTES
- F. USED OIL AND ANTIFREEZE

WHAT CAN BE DONE?

| | |
|---------|----------|
| PROBLEM | SOLUTION |
| PROBLEM | SOLUTION |

TRASHY SOLUTIONS

OBJECTIVES

The student will do the following:

1. Explain why waste disposal is an environmental problem.
2. State three main methods of waste disposal.
3. Give solutions to the problem of waste disposal.

SUBJECT:

Science

TIME:

105 minutes

MATERIALS:

bucket, soil, tissue, aluminum foil, glass bottle, plastic wrap, apple peel, styrofoam cup, spoon, picture of old-time general store, butcher paper, markers or crayons, student sheets (included)

BACKGROUND INFORMATION

Over five billion people inhabit the earth today. As the population of the earth increases, the problem of how to dispose of waste also increases.

Packaging, food scraps, broken appliances, glass, bottles, paper, metals, plastics, old tires, and countless other items quickly fill landfills. Some wastes pose health hazards. Some are biodegradable. Some may be recycled into new products. Others, like some plastics and styrofoam, may take hundreds of years to break down in the environment and may not be recyclable.

In the United States solid wastes are usually disposed of by placement in a sanitary landfill, by incineration, and by recycling such items as metals, paper, glass, tires, and aluminum cans.

Terms

biodegradable: able to be broken down by the action of bacteria and fungi in the environment.

incinerator: a special furnace for burning trash.

landfill: site where wastes are disposed of by burying them under layers of earth.

recycle: to treat or process something so it can be used again in a form similar to its original form (for example, newspapers can be recycled into more newspapers or cardboard).

reuse: to use something again for its original purpose (for example, returnable bottles are reused).

PROCEDURE

I. Setting the stage

- A. Have the students brainstorm a list of the different kinds of items that are thrown away each day. List these on the blackboard.
- B. Divide the students into four groups. Assign each group a category—reusable, recyclable, biodegradable, or worthless. Discuss the meaning of these terms. Ask the groups to divide the list of throwaways into the appropriate categories.
- C. Let each group report the items in the category it was assigned and justify its choices.
- D. Lead the students to the conclusion that there are few items that are worthless and that many of the items that we are throwing away could be used or treated somehow, rather than disposed of.

II. Activity

- A. Show the students a picture of an old-time general store. Ask the students how items bought at these stores were packaged. (Customers usually bought individual amounts of products, which were wrapped in paper or burlap or put in cloth sacks. They often carried purchases home in baskets). Compare this with items purchased at a grocery store today (where items are prepackaged—often in plastic packaging—and carried home in plastic bags). Ask the students what kinds of trash people in pioneer days had and how they disposed of it. (They did not have much trash, but rather used items over for other purposes. They threw what trash they had in ditches or wherever was convenient.) If the trash was disposed of by throwing it down, why is the earth not covered with trash today? Do the following demonstration to investigate this question.
 1. Remind the students of the definition of biodegradable.
 2. Show the students the following kinds of trash—a tissue, a piece of aluminum foil, a glass bottle, some plastic wrap, an apple peel, and a small styrofoam cup. Ask the students which of these items they think might be biodegradable.
 3. Fill a bucket with soil and bury the trash in the “landfill.” Soak the soil with water until it is very wet. Keep the soil wet for seven days.
 4. At the end of the seven days, dig up the buried trash. Ask the students which pieces are beginning to decay. Which are, therefore, biodegradable?
- B. Ask the students to brainstorm about problems associated with the open dumping of trash (ugly, smells bad, attracts rats and other animals that carry disease). Review the term landfill. Tell the students that in a landfill a layer of trash is dumped, smashed down, and then covered with soil. Then another layer of trash is dumped and covered with soil. Ask the students to suggest environmental problems associated with landfills (fill up quickly, problem of toxic chemicals entering the groundwater supply, ugly, smell, and rodents). Reclaimed landfill areas are often sold to developers. Do the following activity to further develop the pros and cons of disposing of trash in landfills.
 1. Divide the students into small groups. Give each group the role descriptions on the student sheet “LANDFILL ROLES,” included.
 2. Have each student choose a role and present a short skit depicting his/her role.

3. Tell the students that an alternative to disposing of trash in a landfill would be to burn the trash. Ask the students if they can think of any environmental problems associated with burning trash (smoke/air pollution; some items, such as plastics, give off toxic gases when burned).
 4. Review the term incinerator.
 5. Tell the students that the incinerators being used today have pollution control devices and other features designed to reduce air pollution.
 6. In addition, new incinerators collect the heat energy produced by burning trash and use it to produce electricity. The heat from the burning trash turns water into steam, and the steam is used to turn a turbine in an electric generator. Therefore, trash can be used to light and heat our homes and power our appliances.
 7. It is estimated that 80 percent of the trash that is produced in the United States could be burned to produce electricity. Lead the students to the realization that using "trash power" could relieve part of the problem of decreasing supplies of fossil fuels as well as relieve part of the problem of land pollution from waste disposal.
 8. Ask the students if they think incineration is an ultimate answer to waste disposal problems; in other words, what problems does incineration present? Remind the students of the air pollution problems discussed earlier, and lead them to think about ash disposal and the problems of burning materials that might otherwise be recycled or allowed to degrade.
- C. Perhaps 80 percent of the trash that is produced in the United States could be burned to produce electricity and most of the remaining 20 percent could be recycled. It takes approximately 500 years for a thin aluminum can to break down, 350 years for a plastic bottle to decompose, and glass is thought to last indefinitely. Recycling reduces the amount of waste with which we must deal and requires less energy than making new products from raw materials. For example, recycling aluminum cans uses less than one-tenth of the energy it takes to make new cans. To explore the possibilities of recycling, do the following activities.
1. Distribute copies of the student sheet "TERRIFIC TRASH," included.
 2. Instruct the students to circle all the items in the picture that could be recycled (glass bottle, plastic milk jug, newspaper, can, paper bag, tire, etc.). Have the students justify their choices.
 3. Divide the students into four groups. Assign each group one of these items—old tire, newspaper, glass, aluminum can. Have the groups list as many items as they can think of that could be made from the recyclable items they were assigned.
 4. Tell the students that some communities have passed laws requiring trash to be sorted at home before it is collected by the sanitation department. It must be sorted according to whether it is glass, metal, paper, food scraps, or other household garbage.
 5. Ask the students what in the picture could be reused. (The glasses could be given to a charity that collects eyeglasses for needy people. The television could perhaps be repaired and used again.) What biodegradable trash could be put to use? (The apple core and other food scraps could be composted and later used as fertilizer.)

III. Follow-up

- A. Have the students complete the following tasks:
 1. Define biodegradable. (able to be broken down by the action of bacteria and fungi)
 2. List several items (4 or more) which are biodegradable. (paper products, food products, some clothes, plants or wood, and so forth)
 3. Define non-biodegradable. (not able to be broken down by the action of bacteria or fungi)
 4. List several items (4 or more) which are nonbiodegradable. (aluminum, glass, most plastics, styrofoam containers, and so forth)
 5. Write several sentences to explain why waste disposal is an environmental problem.
- B. The students will complete the student sheet "WASTE DISPOSAL," included.
- C. Have the students develop a list of possible solutions to the environmental problems of waste disposal. Write the list on the board. Divide a long piece of butcher paper into sections. Have the students make a mural showing possible solutions.

IV. Extension

- A. Have the students investigate the effect of land pollution on wildlife. For example, scientists have found a link between the decrease in leatherback sea turtles and non-biodegradable plastic bags that get thrown or blown into the ocean. The sea turtles think the bags are jellyfish (their favorite food), eat them, and die.
- B. Students may record and plot a graph showing an inventory of the trash in your classroom. What could be recycled or reused?
- C. Recycled paper can be made from old newspapers or used notebook paper.
- D. Have students research legislation passed in New Jersey and New York that requires household trash to be sorted. They might conduct neighborhood polls to see if people in their community would be willing to sort their household trash.

RESOURCES

Alexander, G. M., et. al. Science, Grades 4 & 5. Glenville, IL: Scott, Foresman, 1984.

Holmes, N. J., et. al. Gateway to Science, Grade 5. New York: Webster Division, McGraw-Hill, 1985.

Sopis, K. and J. Sopis. Spaceship Earth: Danger! Danger! Danger! New York: Holt, Rinehart and Winston, 1973.

LANDFILL ROLES

1. You are a property owner whose property adjoins a proposed landfill site. What will your position be—pro or con—for the building of the landfill?
2. You are a land developer. You understand that the reclaimed landfill property will be sold at a low price. What will your position be?
3. You are a farmer whose farm is near the proposed landfill site. Your water source is wells. What is your position on the proposed landfill site?
4. You are an environmentalist. The proposed landfill will be built on an area that used to be considered unusable because it is under water part of the year. What effect will the landfill have on plant and animal species now in the area?
5. You are a city planner. The development of the proposed landfill will allow the city to annex (add to the city) a new portion of the county. What is your position on the proposed landfill?

TERRIFIC TRASH

Circle all the items that could be recycled.



WASTE DISPOSAL

Match the terms to their meanings.

1. recycle

furnace for
burning trash

2. landfill

to treat or process
something so it can
be used again

3. incinerator

site where wastes
are disposed of
by burying them
under layers
of earth

THIS LAND IS YOUR LAND

OBJECTIVES

The student will do the following:

1. Describe changes in land caused by building, farming, mining, and logging.
2. Define erosion and explain how water and air pollution might increase as land is left bare and erosion begins.
3. Discuss ways to reclaim damaged land.

SUBJECT:

Science

TIME:

105 minutes

MATERIALS:

picture of woodland, 2 cookie sheets and soil to cover them 3 or 4 cm thick, 2 bricks, leaves/twigs/small plants, watering can, rectangular cake pan or box with soil, chocolate kisses, plastic straws, plastic spoons, student sheets (included)

BACKGROUND INFORMATION

As the population on earth increases, we must grow more food and make more products. We must build more houses, schools, roads, and factories. This requires changes in land usage, and these cause changes in the environment. Building, farming, mining, and logging require the land to be stripped of trees and other vegetation that hold down the soil itself, as well as the moisture and nutrients in it. Loss of vegetation also reduces the oxygen that plants add to the atmosphere.

Rain that falls on bare land will run off instead of soaking into the ground and, as it goes, it will carry soil with it. As this occurs, soil is washed into streams, increasing water pollution. The loss of valuable topsoil through erosion means a decrease in the productivity of the land.

In cities with large paved areas, almost all the water falling as precipitation goes into the sewers and then into rivers and streams. This may result in flooding, which further erodes the land.

Much effort is being spent on restoring damaged land. Wood products companies practice reforestation and mining companies must reclaim the land they use. Farmers are encouraged to practice soil conservation measures to prevent erosion.

Terms

erosion: the wearing away of the land by water and wind.

reclamation: returning land used for mining or some other purpose to a useful or good condition.

shaft mining: method of extracting coal lying 200 feet or more under the ground; also called underground mining or deep mining.

surface mining: method of extracting coal lying less than 200 feet below the surface of the earth; also called strip mining.

PROCEDURE

I. Setting the stage

- A. Show the students a picture of a wooded area. Discuss with the students what wildlife might be found there and what benefits to the environment might come from this area. Lead the students to understand that the trees and other vegetation are holding moisture and nutrients in the soil, keeping the soil from washing away, and adding oxygen to the air.
- B. Divide the students into four groups—builders, farmers, miners, and loggers. Tell each group that it has purchased the land in the picture and intends to develop it (build on it, farm it, mine it, or harvest trees). Have the groups brainstorm as to what environmental impacts their particular activities might have on the land and the wildlife in the area. Have the members of each group share their ideas with the other groups.

II. Activity

- A. Introduce the term erosion. Tell the students that any of the activities—building, mining, farming, or logging—could cause erosion. Do this activity to study erosion.
 1. Cover each of two cookie sheets with a compressed layer of soil about 3 or 4 cm (1-1.5 inches) thick. Cover the soil on one of the cookie sheets completely with leaves, twigs, and small plants. Leave the other pan's soil bare.
 2. Incline the cookie sheets equally by putting a brick underneath one end of each of them. Put a pan at the bottom of each cookie sheet to catch the water that will run off when you simulate rainfall.
 3. Sprinkle an equal amount of water on both cookie sheets, simulating rainfall. Have the students note the amounts and the contents of the runoff from each pan.
 4. Discuss with the students the results they observe. The runoff from the bare soil should contain much more soil than the runoff from the covered soil. Relate this to the amount of soil that is washed away or eroded from building projects and farming, mining, or logging operations that strip the land of vegetation.
 5. Point out to the students that this runoff containing topsoil enters streams and rivers, filling them with debris, and thus polluting them. Remind the students that the layer of topsoil covering the earth is very thin. If it is washed away by erosion, the soil that is left is not as productive for growing crops or forests.
- B. Tell the students that the most abundant fossil fuel in the United States is coal. It was formed many millions of years ago when plants died in swamps and partially decayed, changing into peat. Pressure and heat turned the peat into different kinds of coal. Coal is found today in layers, or beds, between layers of rock. Some coal beds are so far underground that deep mines must be dug to reach the coal. If the coal is close to the surface, it can be surface or strip mined. Do the following experiment to learn more about coal mining and its effect on the environment.
 1. Tell the students that in surface mining, vegetation, soil, and rock at the earth's surface are stripped away to reach the coal. This is cheaper than digging underground mines, but it presents environmental problems. As vegetation is stripped away and the soil and rock is dug up, erosion becomes a problem. The wastes from surface mines often wash into streams, clogging or polluting them. Surface mining may be done on land that could be used as farmland to produce food.

2. If the coal is buried more than 200 feet under the earth's surface, it is mined underground through a shaft dug into the earth. Environmental problems associated with underground mining include harmful substances that are released into the water and air in mines; these necessitate water treatment and air monitoring. Iron sulfide in coal creates an acid when it reacts with water draining through the mines. This acid can now be chemically treated to make it less dangerous before the water is discharged into streams. Dust in mines can cause lung disease; Federal law prohibits mining if there is too much dust in the air. Dust is controlled by wetting coal or spraying water on the shaft walls.
 3. Have the students try their hands at mining. Prepare a model mine for the class to use (or build several smaller models for use by small groups). Fill a large box (or rectangular cake pan) with soil. Bury "coal" samples (chocolate kisses in foil wrappers or small balls of aluminum foil) at various levels throughout the soil. Leave some partially exposed or close to the top of the soil to represent coal available by surface mining, and bury other samples deeper to represent coal that will have to be shaft-mined. Cover the surface of the soil with leaves, twigs, and small plants (or figures of trees).
 4. Have the students sketch a diagram of the mine model for future reference. Tell the students that Federal and State governments have passed laws that require mining companies to reclaim damaged land—restore it to a useful, good condition. Mining companies must plan the reclamation process before digging begins, so ask the students to plan how they will reclaim their mined land. Sometimes the land must be reclaimed to its original use; other times the land may be restored in an alternative way. For example, some surface mines are used for waste disposal. (Waste is used to fill up the hole dug out in mining operations). Other surface mines are allowed to fill up with water to form lakes for fishing, swimming, and boating.
 5. Have the students take core samples, using straws, to determine where coal is and which coal beds need underground mining or surface mining. (The students are to push the straws straight down into the soil to locate the "coal.")
 6. Have the students strip the vegetation from the area to be surface mined. Give them the spoons and let them mine the coal. Remind them to save all the soil they remove to use in reclamation.
 7. As the students are mining, have them list any environmental problems they might be causing.
 8. After the surface mining is complete, have the students deep mine by digging down and tunnelling to recover coal buried deeper in the soil (they may use toothpicks or sticks as braces). Does this type of mining require as much vegetation removal? (no) Are the environmental problems the same as or different from those caused by surface mining? Have the students keep their surface-mined and shaft-mined coal separate. Explain that shaft-mined coal is more expensive to produce, while surface mining requires more reclamation. Ask the students which they think would be more economical overall. (surface mining)
 9. Have the students reclaim their land. Does it look just like it did in their original sketches or are they reclaiming the land for another use?
- C. Another land usage problem is occurring in tropical rainforests around the world, especially in the Amazon Basin in South America. Clear cutting of trees is being done in the rainforests to provide more farmland to grow food for the increasing population and for export to wealthier countries and for development. Divide the class into small groups to debate the following points.
1. What effect will clear cutting have on the plants and wildlife living in the rainforest?

2. One reason the clear cutting is being done is to provide more farmland for growing food, including pastureland for grazing cattle. Because of the abundant rainfall in the area, however, the soil is actually very poor and all its nutrients are close to its surface. (In fact, the soil has few nutrients; it is the lush plant life of the rainforest that holds most of the nutrients.) When the trees and vegetation are removed, the topsoil quickly erodes. Because the land is cleared, there is no lush growth to put nutrients back into the soil, so the cleared fields are only good for growing crops for a few years. They are then usually abandoned. Ask the students if they think the clear cutting actually is beneficial. (Remind them that rapidly growing populations need more communities and more food.)
3. The amount of rainfall in the Amazon Basin has decreased by about 25 percent in recent years. Do the students think this could be related to the clear cutting in the area? (Yes; fewer leafy trees result in less water being released into the air. Compounding the results of this decrease is the fact that the removal of a large number of trees also raises the temperature of the area, so more water is needed by remaining vegetation.)
4. Ask the students what might be a possible solution to the problem of clear cutting in the Amazon Basin. Should it be banned altogether? (No; it provides jobs, lumber, and some food. It should be monitored carefully, and areas that are cleared should be replanted in trees immediately to prevent erosion and to reestablish the balance of nature. Other areas should be developed for farmland.)

III. Follow-up

- A. Have the students draw a "before" and "after" picture of the land their groups developed in the "Setting the stage" activity. Let the builders, farmers, miners, and loggers draw pictures of their property before operations began and after the operations were finished.
- B. Have the students complete the student sheet "SURFACE OR SHAFT?," included.
- C. Divide the students again into the original four groups (builders, farmers, miners, and loggers). Have each group come up with a plan for "recycling" the land they have used. They may write about their plans or make diagrams. Let each group share its plan with the class.

IV. Extension

- A. Have the students develop a plan to make their community an environmentally better place to live. They should consider existing land uses, such as waste disposal areas and residential areas. What would they rearrange or eliminate?
- B. Much development is being done along coastal areas of the United States. Shallow bays, swamps, and marshes are often filled in to create land for real estate developments. Discuss with the class the environmental impacts of this practice.
- C. Have the students write the American Coal Foundation (Address: 918 Sixteenth St., Suite 404, Washington, D.C. 20006-2902) for more information on mining procedures and reclamation of mined areas.

RESOURCES

"About Coal." South Deerfield, MA: Channing L. Bete, 1987.

Alexander, G. M., et. al. Science - Grade 5. Greenville, IL: Scott, Foresman, 1984.

Center of Excellence for the Enrichment of Science and Mathematics Education, The University of Tennessee at Martin. Conservation Education Activities Manual K-6. Martin, TN: Author, 1986.

National Coal Association. "Facts About Coal." Washington, D.C.: Author, 1986.

National Wildlife Federation. Naturescope: Trees are Terrific. Washington, D.C.: Author, 1985.

Tennessee Energy Education Network. "How the Cookie Crumbles" (activity). (Address: Sixth Floor, 320 Sixth Avenue, North, Nashville, TN 37219-5308, ATTN: Ms. Dawson. Telephone: 1-800-342-1340.)

SURFACE OR SHAFT?

List the good and bad things about each kind of coal mining.

| | | |
|---------------------------------|------|-----|
| S U R F A C E | GOOD | BAD |
| | | |
| S H A F T | GOOD | BAD |
| | | |

GLOSSARY

- acid:** any substance that turns litmus paper red; an acid has a pH of less than 7 (neutral).
- acid rain:** rainfall with a pH below normal (about 5.6); results from the reaction of sulfur oxide and/or nitrogen oxide pollutants with water vapor in the atmosphere.
- atmosphere:** an envelope of air surrounding the earth.
- base:** any substance that turns litmus paper blue; a base has a pH of greater than 7 (neutral).
- biodegradable:** able to be broken down by the action of bacteria and fungi in the environment.
- carbon monoxide:** a colorless, odorless, poisonous gas given off when vehicles burn fuel or when kerosene or wood stoves are operated.
- condensation:** the changing of water vapor to liquid.
- conservation:** managing or using a resource wisely and efficiently.
- dilute:** to make weaker (less concentrated) by adding water.
- erosion:** the wearing away of the land by water and wind.
- evaporation:** the changing of liquid water into water vapor.
- fossil fuels:** coal, oil, and natural gas that were formed millions of years ago from the remains of plants and animals.
- groundwater:** water that seeps down into the earth to be stored in rocks underground; the source of water from wells and springs.
- hazardous substance:** material that presents a danger to health or the environment.
- incinerator:** a special furnace for burning trash.
- infiltration:** the process by which water seeps into the earth.
- kilowatt:** 1,000 watts.
- kilowatthour:** 1,000 watts of electricity used for one hour.
- landfill:** site where wastes are disposed of by burying them under layers of earth.
- lead:** a pollutant released into the air by vehicles burning leaded gasoline.
- litmus:** a material used to test for acidity or basicity; contains chemicals that turn red when touched by an acid and blue when touched by a base.
- neutral:** any substance that is neither an acid nor a base; a neutral substance has a pH of 7.
- nitrogen oxides:** gases given off from vehicles and some power plants; contributors to acid rain and ozone pollution.

nonrenewable resources: resources that are limited and can be used up (such as fossil fuels); resources that cannot be replaced, replenished, or regrown.

ozone: a gas formed from nitrogen oxide pollutants in the presence of sunshine.

particulates: small pieces of dust, soot, or other matter that fall from the air.

pH: numerical scale measuring the acidity (how much like vinegar) or basicity (how much like ammonia) of a solution; ranges from 0 to 14, where 7 is neutral and values greater than 7 indicate basicity and less than 7 indicate acidity; normal pH for rainwater is 5.6.

pollutants: materials that make something impure or contaminated.

pollution: the process of making something impure or contaminated.

precipitation: forms of condensed water vapor that are heavy enough to fall to earth, such as snow, rain, and sleet.

radiation: energy given off by atoms undergoing nuclear decay (changes in their nuclei).

reclamation: returning land used for mining or some other purpose to a useful or good condition.

recycle: to treat or process something so it can be used again in a form similar to its original form (for example, newspapers can be recycled into more newspapers or cardboard).

renewable resources: resources which cannot be used up (such as the sun or wind) or that can be replaced, replenished, or regrown (such as forests and crops).

resources: supplies useful or valuable things we use to make things we need or want.

reuse: to use something again for its original purpose (for example, returnable bottles are reused).

sewage: wastewater containing human waste.

shaft mining: method of extracting coal lying 200 feet or more under the ground; also called underground mining or deep mining.

smog: smoke and fog trapped close to the earth's surface; caused by air pollutants being trapped in air masses over cities.

sulfur oxides: gases given off when power plants and factories burn coal; major contributors to acid rain; sulfur dioxide is the main sulfur by-product of burning coal.

surface mining: method of extracting coal lying less than 200 feet below the surface of the earth; also called strip mining.

surface water: water that can be seen above ground, such as that in lakes, rivers, and streams.

thermal pollution: the addition of heated water to a body of water (such as a lake or stream).

vapor: a substance in a gaseous state.

water cycle: continuous cycle of water evaporating, condensing into a cloud, and falling back to the earth in some form of precipitation; recirculates water through the closed system of our planet.

watt: a unit measuring electricity.

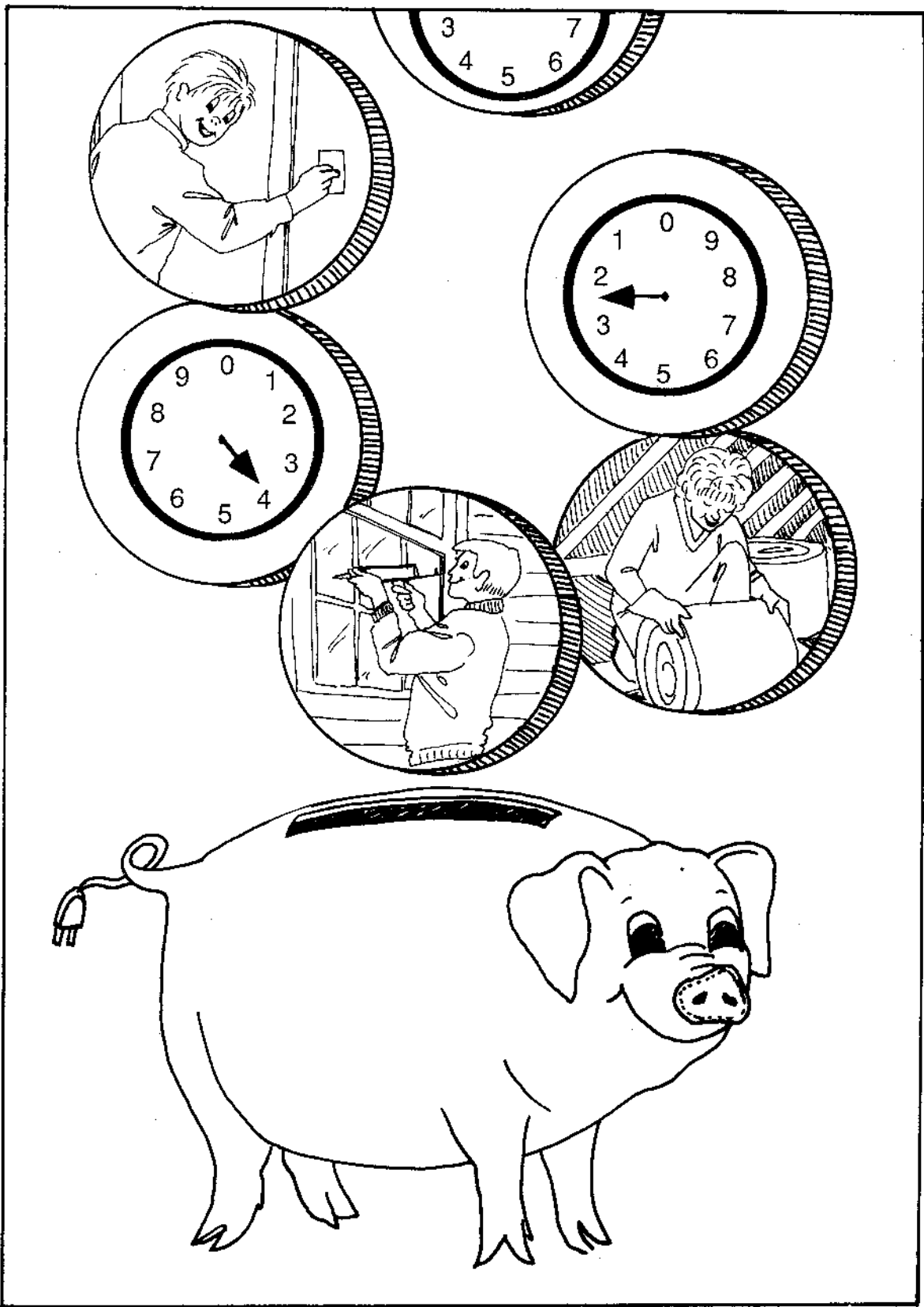

ENERGY
CONSERVATION

YESTERDAY AND TODAY

OBJECTIVES

The student will do the following:

1. Interview someone who grew up before the days of great electricity usage.
2. Dramatize the changes in lifestyle due to increased energy usage today.
3. Compare average monthly electricity usage for his/her family and the families of his/her parents and grandparents.

SUBJECTS:

Science, Math

TIME:

90 minutes, plus take-home activities

MATERIALS:

teacher sheet (included),
student sheets (included)

BACKGROUND INFORMATION

Many people call the past the "good old days". Although it is common for people to be nostalgic, most would not throw out their machines, conveniences, and leisure time, and return to the "good old days" of our grandparents' childhoods, when most work was done by animal and human muscle power. Our Nation's standard of living is much higher than it was only 50 years ago. Much of this is due to the development and heavy use of energy-consuming devices. Our dependence upon these devices has caused a great increase in the amounts of energy we use each day. This is easily demonstrated by an examination of household energy use for normal daily operations. Electricity is our energy form of choice for household use, so consideration of our families' use of electricity as compared with electricity use by the two generations preceding us will show how much more energy we use today.

Terms

labor-saving devices: devices developed to decrease or replace human labor, especially manual labor.

lifestyle: the way of life which is characteristic of an individual or a group of people.

standard of living: the degree or level of material well-being of an individual or group.

PROCEDURE

- I. Setting the stage
 - A. Share the background information with the students, defining and discussing the terms with which the students may not be familiar.
 - B. Read to the students the story on the teacher sheet "APRIL 1937," included. Lead the students in a discussion of their thoughts on the days of their grandparents.
 - C. Have the students bring in pictures of scenes representative of the past and the present. Together with the students, discuss how the pictures differ.

II. Activity

- A. Have the students conduct interviews to learn more about lifestyles in the past.
 1. Give each student a copy of the student sheet "THE GOOD OLD DAYS?," included.
 2. Have each student identify someone at least 50 years old (a grandparent, neighbor, friend or other acquaintance) who would be willing to participate in an interview. (NOTE: You could invite several senior citizens to the classroom to answer the students' questions.)
 3. Together with the students, read and discuss the directions and questions on the interview sheet. Give the students some pointers on successfully conducting interviews.
 4. Have the students return their completed interview forms after they have conducted the interviews.
- B. Have the students compare their use of energy-using devices to their parents' and grandparents' use of household appliances.
 1. Give each student a copy of the student sheet "TODAY AND YESTERDAY," included. Explain that completion of the handout will help them see how the use of electricity has increased over the past 50 years. They are to check the listed appliances that their families use now.
 2. Have the students check with their parents for the appliances they used when they were children. Have the students mark the appliances they think their grandparents might have used. They may use information from their interviews or ask their grandparents about the listed appliances.
 3. Tell the students the following information:

If you had lived in the year 1900, you probably would have used only one-fourth of the total energy you use today. You probably would not have used any electricity at all. In the year 2000, you probably will use much more than you use today.
 4. Ask the students what might happen as energy demand increases still more.

III. Follow-up

- A. Have the students discuss and list ways they might alter their lifestyles to match the lifestyles of yesterday.
- B. Divide the students into two groups and have them write and perform skits showing the difference between lifestyles today and 50 years ago. Have them focus on how lifestyles have changed due to increased use of energy today.
- C. Have each student select the role of a character from history and write a journal entry with an energy slant.

RESOURCE

Alabama Power. The Energy Challenge for Grades 5 - 8. Birmingham, AL: Author, n.d. (Address: Alabama Power, Educational Services, P.O. Box 2641, Birmingham, AL 35282-9984. Telephone: (205) 250-2552.)

APRIL 1937

It is April 1937. Roy, a nine-year-old boy, and his eleven-year-old sister, Margie, live on a farm; most of the families in the Tennessee Valley do.

The day begins at 4:30 a.m., when their mother's wind-up Big Ben alarm clock can be heard all over the house. Mother is the first one into the cold kitchen, where she lights the fire in the wood stove and gets breakfast started. Roy and Margie get dressed and go to the barnyard to do their chores. They do the milking first. Roy carries the milk buckets to the root cellar where it is cool; they do not have a refrigerator. He then feeds the cow, the mule, and the pigs. Margie helps Roy with the milk, then feeds the chickens, collects the eggs, and takes some milk from the root cellar for breakfast. Father checks the garden to see if the soil is dry enough to plow, then goes to the shed and begins getting the harness and yoke ready so that he can hitch the plow to the mule, Sadie. Plowing is Sadie's and Father's job; tractors are rare in this part of the country.

Mother calls them to breakfast and they hurry in to sit down to a meal of sugar-cured ham, eggs, just-baked biscuits, and homemade jam.

After breakfast, Roy and Margie draw the water needed for the day's cooking and washing. Then they walk two miles to their one-room school house, carrying their books and lunch pails. There is only one teacher; she not only teaches all the subjects and all the students, but she is responsible for maintaining the school. She has arrived early to light a fire in the school's wood stove; the April morning is chilly and the warmth from the stove will feel good.

While the children are at school, Father and Sadie plow the rest of the garden. The garden's tomatoes, beans, corn, and other vegetables make up most of the family's diet for the year. As he plows, Father hopes the weather this year will be good and that the government agents will bring him some more fertilizer for his crops. Last year's garden supplied the family with enough corn meal and canned and dried vegetables to make it through the winter; there was even enough to sell some.

Mother builds a fire under the big black pot filled with water and washes the clothes. Some she scrubs on a washboard. Then she hangs them on a line to dry. She puts a big pot of pinto beans on the wood stove to cook all day. Later, when the clothes are dry, she irons them with a flat iron that she heats up over the fire and reheats after every few garments.

APRIL 1937

(continued)

After they walk home from school, Roy and Margie work on their lessons. Then they play outside for a little while, and return to the barnyard to do their evening chores. The cow must be milked again and the animals must be fed and tended. For supper, Mother serves the pinto beans, some fried potatoes, and a large pan of cornbread. The family is thankful the garden has supplied enough vegetables for the year. When they finish supper, Margie washes the dishes in a pan filled with water heated on the stove, Mother puts away the dishes, and Roy and Father chop the wood and fill the wood box for the next day's use.

When the chores are finished, Father reads a story by the light of the kerosene lamp. Mother sits down at the pump organ and they all sing some songs together before retiring. The bedrooms are chilly so they snuggle in their beds under quilts Grandma made.

Roy and Margie look forward to going to their cousins' house on Saturday night, where the family gets together to listen to the Grand Ole Opry on the radio. Their cousins live much closer to town and have electricity. When it is time to go home, they will climb back in the wagon hitched to Sadie. Some of their relatives have cars or trucks. Roy and Margie hope Father will soon have enough money to buy one. He says the Great Depression is over and times are getting better, so maybe they will soon be able to buy some things the family does without.

Roy and Margie look forward to summer vacation. School will end in May. There will be much to do to care for the garden and the animals and to harvest and preserve the vegetables, but there will be time for fishing in the stream, swimming in the swimming hole, and picking berries.

Too soon it will be September. Most of the crops will be harvested and Father will have the money he makes from selling what the family will not need. It will be time to buy each one's new pair of shoes. Roy and Father will get new overalls. Mother and Margie will pick out some material for making new dresses. There will be much work to do to prepare for another winter. There is always work to do on the farm.

THE GOOD OLD DAYS?

Interview someone who is old enough to remember what life was like before the usage of electricity became so common. Be sure he or she is at least 50 years old. Ask the questions that follow. You may think of other questions to ask also.

1. What kind of lights did you use in your home? _____

2. How was your home heated? _____

How was it cooled? _____

3. Of what fabrics were clothes made? _____

Was clothing harder or easier to care for than clothing today? _____

What kind of washing machine did you have? _____

How was laundry dried? _____

4. What kind of stove and/or what kind of fuel did your family use for cooking? _____

5. Did you have a refrigerator? _____ If not, how did you keep your food fresh?

6. How was food packaged when it came from the store? _____

Did your family grow much of its own food? _____

7. What sorts of items did your family purchase? _____

What sorts of items did your family make for itself? _____

8. What did milk come in? _____ Was your milk delivered? _____

If so, how? _____

THE GOOD OLD DAYS?
(continued)

9. What sort of soap did you use? _____ Did it clean as well as the
cleaners we have now? _____
10. How was your water heated for bathing, dishwashing, and laundry? _____
11. Did your family have a car? _____ If not, how did you travel? _____
How did you get to school? _____
12. Did you have a radio? _____ What did it look like? _____
Did you go to the movies? _____ What other kinds of entertainment did you
enjoy? _____
13. Make a list of additional questions. Ask them during the interview. Put the questions
and answers on the back of this page.
14. To close the interview, ask the following questions and write the answers below. If
more space is needed, use the back of this page.
- a. In what ways is life more enjoyable now that we have much electricity and have
many more products?

- b. In what ways did you like the "good old days" better?

TODAY AND YESTERDAY

This is a list of electric appliances found in many homes today. Electricity is measured in kilowatthours (kWh), just as gasoline is bought by the gallon. The average number of kWh each appliance uses in a month is given. Write the number of kWh for each appliance your family uses in the column "Your Family." Do the same for your parent's family and your grandparent's family. Add the kWh for each column to see how many more kWh of electricity we use than did our parents and grandparents.

| APPLIANCE | AVERAGE ELECTRICITY (KWH) USED IN ONE MONTH | YOUR FAMILY | YOUR PARENT'S FAMILY | YOUR GRAND- PARENT'S FAMILY |
|------------------------|--|----------------|----------------------------|--------------------------------------|
| Dishwasher | 35 | | | |
| Microwave Oven | 16 | | | |
| Electric Range | 98 | | | |
| Blender | 1 | | | |
| Can Opener | 1 | | | |
| Electric Clock | 1 | | | |
| Automatic Coffeemaker | 8 | | | |
| Toaster | 3 | | | |
| Slow Cooker | 12 | | | |
| Refrigerator | 152 | | | |
| Vacuum Cleaner | 4 | | | |
| Clothes Washer | 9 | | | |
| Electric Clothes Dryer | 80 | | | |
| Space Heater | 75 | | | |
| Electric Water Heater | 400 | | | |
| Color TV | 55 | | | |
| B&W TV | 30 | | | |
| Radio/Record Player | 9 | | | |
| Power Saw | 4 | | | |
| Electric Blanket | 12 | | | |
| Hair Dryer | 10 | | | |
| Electric Toothbrush | 1 | | | |
| Room Air Conditioner | 72 | | | |
| Electric Fan | 12 | | | |
| Electric Furnace | 1100 | | | |
| Yard Light | 30 | | | |
| Garage Door Opener | 1 | | | |
| TOTALS: | _____ | _____ | _____ | _____ |
| | **** | | | |

WASTING ENERGY AT HOME?

OBJECTIVES

The student will do the following:

1. Write a definition for conservation.
2. Identify ways energy is wasted.
3. List ways to conserve energy in the home.
4. Categorize home appliances as heavy, moderate, or light users of energy.

SUBJECT:

Science

TIME:

45 minutes, plus take home activity

MATERIALS:

crayons or colored markers, teacher sheet (included), student sheet (included)

BACKGROUND INFORMATION

We use more energy each year than we used the previous year. In fact, during the 20th century, the amount of energy our Nation uses has doubled about every 20 years. We used twice as much energy in 1955 as in 1935 and nearly twice as much in 1980 as in 1960. The rates of increase in our energy consumption have slowed somewhat, but we continue to use more and more energy.

Energy conservation—the wise and efficient use of energy—was not thought of before the “energy crisis” of the 1970s. When a shortfall in imported oil shipments and a dramatic rise in oil prices caused energy costs to skyrocket, we became concerned about saving energy. Today, energy costs have stabilized and the economy is stronger, but we still need to think about, and practice, energy conservation. Not only does energy conservation save us money on our energy bills now, it saves us (and consumers in the future) money in the long run by making our irreplaceable energy resources last longer.

Today’s students are tomorrow’s consumers. Developing energy conservation skills will serve them well in the future, when prices are certain to be higher than they are now. Additionally, students may be able to help their families conserve energy at home, benefiting themselves and others both now and in the future.

Terms

appliance: an instrument or device designed for household use especially operated by electricity.

conservation: the wise and efficient use of resources (e.g., energy resources).

energy: the ability to do work.

PROCEDURE

I. Setting the stage

- A. Define energy conservation and share the background information as appropriate.
- B. Give each student a copy of the student sheet "WASTING ENERGY," included.
 1. Have the students draw an "x" on the ways energy is being wasted.
 2. Ask the students, "How can energy be conserved in this picture?" (turn off lights, turn off TV, close door; some students may suggest covering the window and/or carpeting the floor)
 3. Have the students list examples of how energy is conserved in their homes.

II. Activity

- A. Give each student a copy of the student sheet "HOW TO CONSERVE ENERGY IN YOUR HOME," included. Discuss the directions with the students. Have the students take the sheet home and complete it with the help of their parents.
- B. Have the students identify energy users and wasters in their homes.
 1. Give each student a copy of the student sheet "HOME ENERGY SURVEY," included.
 2. Make a transparency of the teacher information sheet "APPLIANCE ENERGY USE" (included). Have the students list the home appliances pictured on the student sheet ("HOME ENERGY SURVEY") and given on the transparency. Put the following headings on the board and divide the listed appliances into these categories—"Heavy Users of Energy," "Moderate Users of Energy," and "Light Users of Energy."
 3. Discuss with the students which appliances shown on the "HOME ENERGY SURVEY" student sheet they have in their own homes.
 4. Have the students circle in red the depicted energy wasters found in their own homes.

III. Follow-up

- A. Have the students write a definition (in his/her own words) of conservation.
- B. Have the students list five ways to conserve energy in the home.

- C. Have the students make a chart (similar to the one below) based on the information they marked on their "HOME ENERGY SURVEY" student sheets. An example is given below:

| ENERGY USERS | WAYS TO REDUCE ENERGY USE |
|--|---|
| 1. Television, lights, radio, phonograph | 1. Turn off when you are not using. |
| 2. Range (stove) | 2. Cover pots; thaw frozen foods before cooking; plan meals carefully. |
| 3. Washer | 3. Wash full loads; use cold water. |
| 4. Car | 4. Walk; ride in carpools; ride a bike; observe speed limits; keep car in good running condition. |
| 5. Bath | 5. Short shower instead of deep bath; take shorter shower or shallower bath (use less hot water). |
| 6. Outside doors | 6. Install storm doors; keep doors closed when using heat or air conditioning; install weatherstripping. |
| 7. Thermostat | 7. Set at 68 degrees in winter and turn down at night; wear warm clothes; set at 78 degrees in summer; wear cool clothes. |
| 8. Fireplace | 8. Close flue when not in use; install glass fire screen that can be closed when fireplace is not in use. |
| 9. Windows | 9. Close draperies at night; put shutters, blinds, or drapes on all windows; install storm windows; install weatherstripping. |
| 10. Appliances | 10. Do not use several heavy users at the same time; turn off appliances when not in use. |

IV. Extension

- A. Invite a speaker from your local power distributor to speak to the class about ways to conserve energy.
- B. Have the students, with the help of their parents, compare several months' utility bills and discuss ways to conserve electricity.
- C. Have the students project what will happen to electrical costs by the year 2000, then write and perform a skit showing a family receiving and paying an electric bill in that year.

RESOURCES

Alabama Department of Economic and Community Affairs, Science, Technology and Energy Division. Energy Savers Activity Book With the Energy Robots. Montgomery, AL: Author, n.d. (p.17) (Address: 3465 Norman Bridge Road, Montgomery, AL 36105.)

Alabama State Department of Education. Energy Activities: A Resource Guide for Grades K - 4. Montgomery, AL: Author, n.d. (p. 84) (Address: State Office Building, Montgomery, AL 36130.)

Energy Source Energy Education Program. Energy in American History. Lakewood, CA: Author, 1982. (pp. 20-21)

McDonald's Corporation. McDonald's Ecology and Energy Action Pack. Oak Brook, IL: Author, 1977. (p. 14) (Address: Director-Corporate Responsibility, McDonald's Corporation, One McDonald Plaza, Oak Brook, IL 60521.)

Nebraska Energy Office. Energy Conservation Activity Packet. Lincoln, NB: Author, n.d. (Telephone: 402-471-2867.)

Tennessee Valley Authority. "How to Insulate Your Attic." N.p.: Author, 1984.

_____. "How to Insulate Your Electric Water Heater." N.p.: Author, 1984.

_____. "How to Read Your Electric Meter." N.p.: Author, 1987.

_____. "How to Save on Your Electric Bills." N.p.: Author, 1984.

WASTING ENERGY

Put an "X" on all the ways you observe energy being wasted.

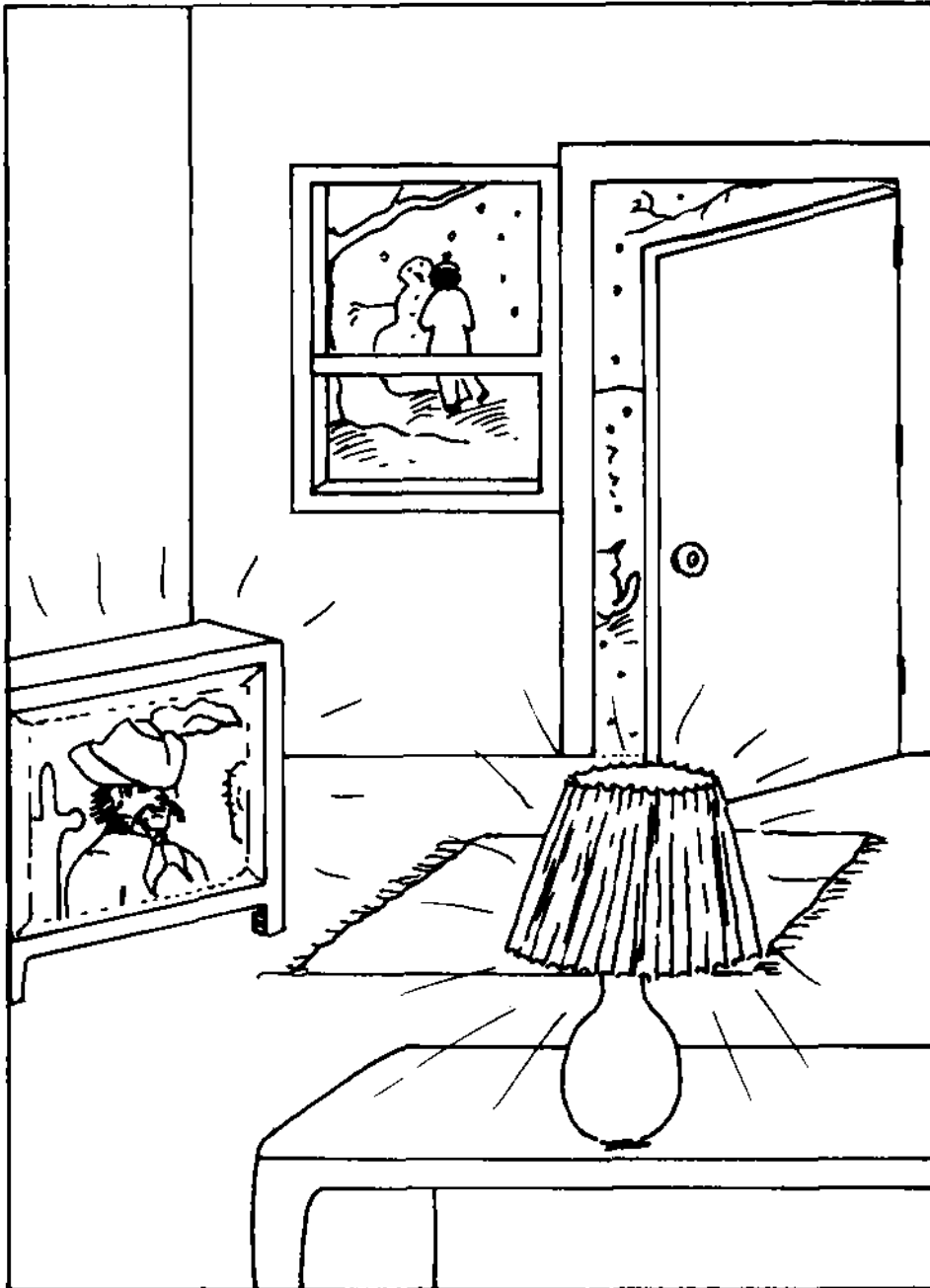

HOW TO CONSERVE ENERGY IN YOUR HOME

Directions: Read each triangular shape. Color the triangular shape light blue if you and your family observe the energy conservation rule. Color the triangular shape yellow if you and your family do not observe the energy conservation rule. Discuss with your family ways to save energy in your home.

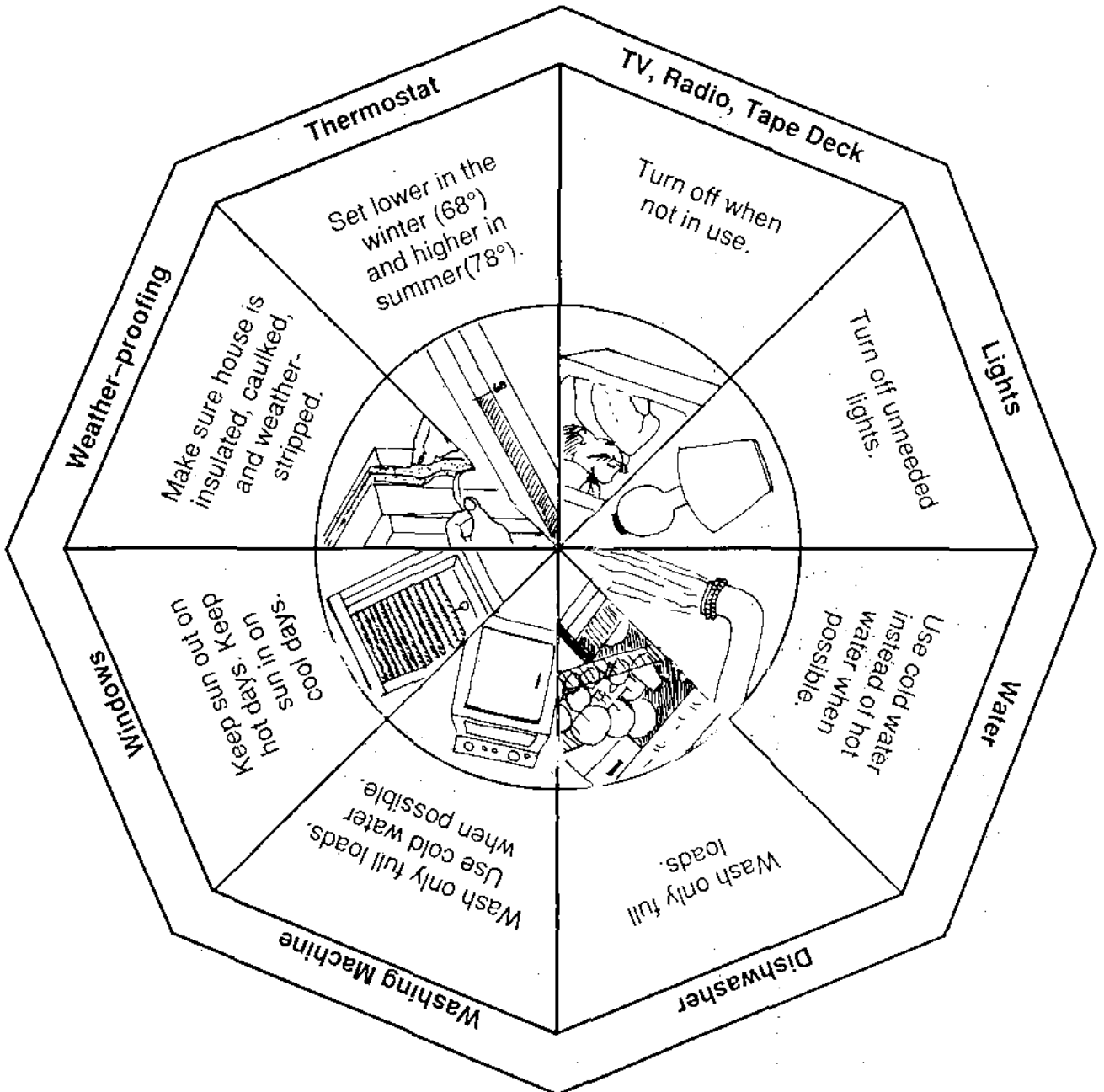

HOME ENERGY SURVEY

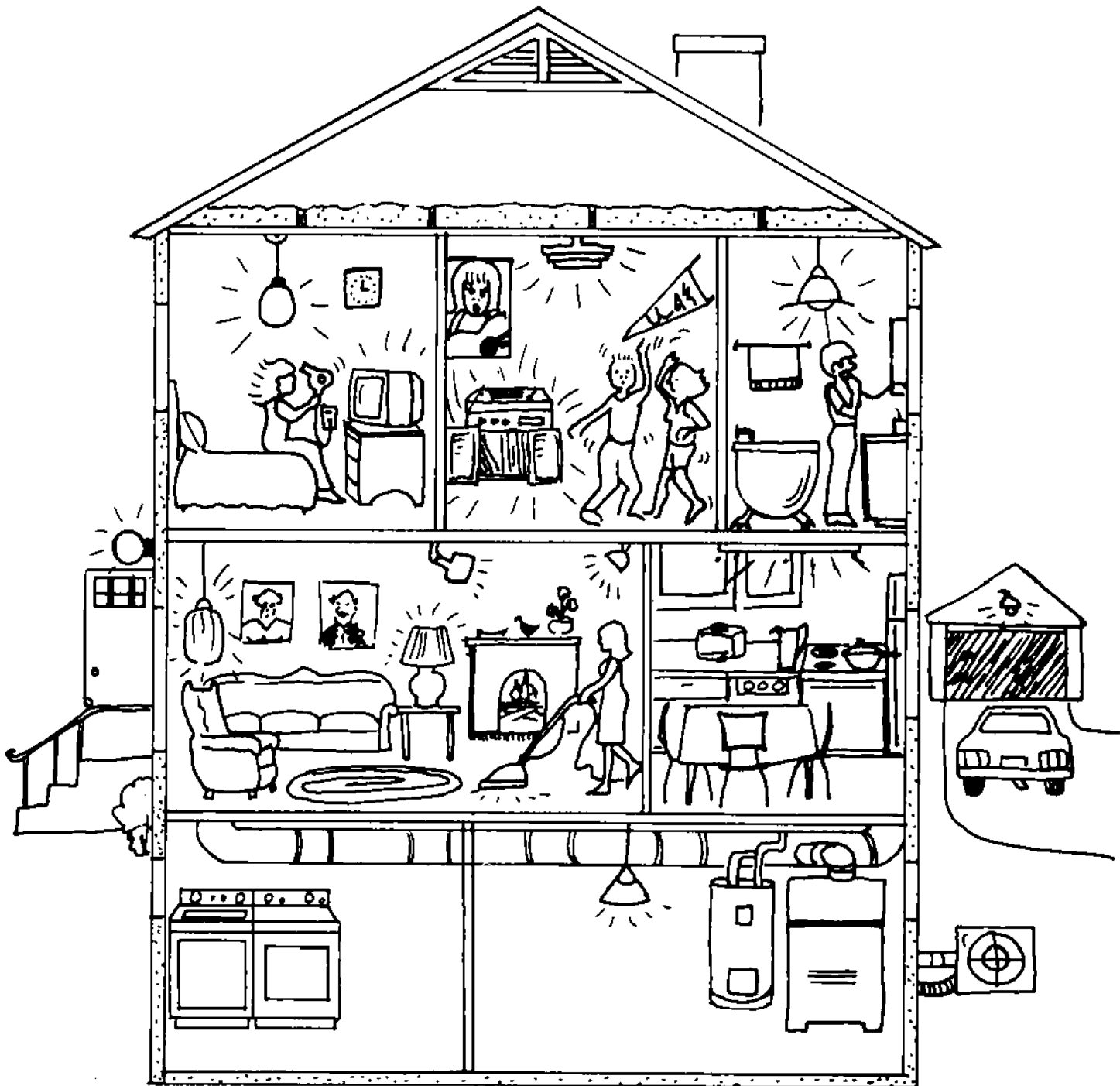

APPLIANCE ENERGY USE

| Appliance | Average kWh Used* | | Appliance | Average kWh Used* | |
|---|-------------------|----------------------|-----------------------------|-------------------|------------|
| | Annually | Monthly ¹ | | Annually | Monthly |
| Kitchen | | | Entertainment | | |
| Range w/self-cleaning oven | 1224 | 102 | Color TV | | |
| Range w/oven | 1152 | 96 | Tube type | 660 | 55 |
| Microwave oven | 300 | 25 | Solid state | 440 | 37 |
| Frying pan | 190 | 16 | B&W TV | | |
| Coffee maker | 110 | 9 | Tube type | 350 | 29 |
| Toaster | 40 | 3 | Solid state | 120 | 10 |
| Mixer | 10 | 1 | Radio/phonograph | 110 | 9 |
| Food disposer | 30 | 3 | | | |
| Dishwasher | 1560** | 130 | Comfort | | |
| Refrigerator/freezer | | | Electric furnace | 13200***** | (Seasonal) |
| 16-25 cu ft side-by-side model, auto defrost | 2160 | 180 | Heat pump | 6600**** | (Seasonal) |
| Refrigerator/freezer | | | Air conditioning | | |
| 14 cu ft auto defrost | 1800 | 150 | Central, per ton | 1500***** | (Seasonal) |
| Refrigerator/freezer | | | Air conditioning | | |
| 14 cu ft manual defrost | 1200 | 100 | Room, one ton | 1500 | (Seasonal) |
| Refrigerator/freezer | | | Dehumidifier | 400 | 33 |
| 17 cu ft, 2-door, high-efficiency, auto defrost | 1200 | 100 | Electric Blanket | 150 | (Seasonal) |
| Freezer, 15 cu ft auto defrost | 1800 | 150 | Attic fan | 300 | (Seasonal) |
| Freezer, 15 cu ft manual defrost | 1200 | 100 | Ceiling fan | 130* | (Seasonal) |
| | | | Other | | |
| Laundry | | | Quick recovery water heater | 4200 | 350 |
| Clothes dryer | 1000 | 83 | Vacuum cleaner | 50 | 4 |
| Clothes washer | 624*** | 52 | Clock | 18 | |
| Hand iron | 150 | 13 | Toothbrush | 0.5 | 0.04 |

*These figures are averages and will vary depending on user habits and lifestyles.

**Includes kWh for heating water used by appliance.

*** Based on warm water wash and cold water rinse.

**** Heat only.

***** Based on 1,500 square foot house insulated to meet TVA standards for energy efficiency. If your house does not meet these standards it may use considerably more electricity during the heating and cooling seasons.

DRESS FOR COMFORT

OBJECTIVES

The student will do the following:

1. Distinguish between clothing materials and designs for different seasons.
2. Design garments for winter and summer wear.
3. Investigate how insulation and color affect heat flow.

SUBJECT:

Science

TIME:

45-90 minutes

MATERIALS:

variety of blouses, shirts, and sweaters (made of different fabrics), scraps of material (at least a square foot each), glue or tape, milk cartons, posterboard, scissors, catalogs or magazines, several pieces of different fabrics (about a yard each), assorted safety pins, construction paper, thermometers

BACKGROUND INFORMATION

Dressing appropriately for the season and temperature can make a big difference in one's comfort level. Even inside, dressing appropriately is important. For example, wearing clothes that are too warm in the summer prompts people to use more air conditioning—and more energy—than they would if they wore cooler clothing. The opposite is true in winter. The ready availability of heating and cooling should not mean that we no longer dress for the seasons. If we are to conserve energy in our buildings, we must dress appropriately.

In cold weather, it is better to wear two or three lightweight layers instead of one heavy layer of clothes. Layers help trap body heat. Tightly fitting clothes, however, reduce the benefits of layering. Fabrics with texture tend to be warmer than smooth fabrics. Bulky knitted, quilted, hairy, or napped fabrics are good for trapping body heat. Trapping body heat is important because, in winter, the air temperature is much cooler than that of the body. Without adequate clothing to insulate the body, it loses too much heat to the air. Winter clothing should be bulky or layered material and should shield the body from the flow of air.

Lightweight fabrics such as gauze, batiste, and chambray are appropriate for hot weather. Loosely fitted clothing lets air circulate and allows heat to leave the body. Clothing of loosely woven fabric with large openings at the neck, arms, and legs is most comfortable in summer. In summer, the body must lose excess heat in order to maintain proper balance and comfort. It achieves this heat loss primarily by perspiring. As perspiration evaporates from the skin, heat energy is taken with it. Summer clothing should be made of lightweight, breathable material and should hinder the flow of air against the body as little as possible.

PROCEDURE

I. Setting the stage

A. Ask the students the following questions:

1. What kind of clothes do you wear on a hot day? a cold day?
2. Of what kinds of fabric are these clothes made?

B. Discuss different fabrics with the students, describing and defining those they do not know.

II. Activity

A. Show the students a variety of blouses, shirts, and sweaters made of different types of fabrics. Some examples are wool, silk, cotton, polyester, nylon, linen, rayon, gauze, and vinyl. Try to provide examples of different weights and textures, such as bulky, gauzy, quilted, silky, and napped.

1. Have the students classify the clothing as either warm weather wear or cool weather wear.
2. You may wish to have the students cut out pictures of clothing from catalogs or magazines and mount them on posters you have designated for different seasons.

B. Share the background information with the students, explaining why clothing's construction and material are important for dressing comfortably in different temperatures.

C. Have the students design garments appropriate for given seasons.

1. Divide the class into two groups. Provide each group with several lengths of material. There should be a variety of fabrics, such as cotton, wool, polyester, and acrylic (fake) fur.
2. Using students as live models and the provided lengths of different material and safety pins, each group is to design a garment that affords the best comfort for winter and another that is appropriate for summer.
3. Have a "fashion show" in which each group will model and explain its designs.

D. Have the students investigate how the type and color of fabrics affect heat flow.

1. Have the students save their milk cartons, wash them, and fill them with water. Put them in the school's freezer and make large ice cubes. Provide one-foot-square scraps of material (cotton, wool, gauze, knits, and so on) for each student. Give each student some scraps, and allow him/her to "dress" his/her ice cube to keep it from melting. After the students have dressed the ice cubes, place them on newspaper or in pans. The ice cube that melts last is the best dressed ice cube.
2. Make several pockets from differently colored construction paper. Insert a thermometer in each pocket. Place the pockets holding the thermometers outside in a sunny location. After 30 minutes, have the students read the thermometers. Record the information on the board, noting the color of the paper and the temperature readings. (NOTE: Choose a day with little or no wind; there will likely be only about two degrees difference.)

III. Follow-up

- A. Have the students re-sort the clothing of different fabrics according to the seasons in which to wear them. Have them explain why the garments are appropriate.
- B. After the ice cubes melt, have each student explain why his/her attempt to delay its melting yielded results as it did.
- C. Have the students write a summary statement about the effect of color on heat flow.

IV. Extension

- A. Take instant snapshots of each group's designs. Have the students use the snapshots and samples of the materials they used to make posters entitled "Best Designs for Comfort." Have them list reasons for their choices of fabrics and designs. Put the posters on a bulletin board.
- B. Have the students research the "R-value" of insulation. Others may look into why certain roof colors are preferred in some areas.

RESOURCES

Alabama Department of Economic and Community Affairs, Science, Technology and Energy Division. The Alabama Comfort Almanac for Senior Citizens. Montgomery, AL: Author, 1986. (p. 17)

Minnesota Department of Education, Minnesota Energy Agency, and Minnesota Environmental Education Board. A Portfolio of Energy Ideas. Saint Paul, MN: Author, 1981. (pp.7-8) (Telephone: 612-296-6104.)

Smith, J. E. Conserve Energy and Save Money. New York: McGraw-Hill, 1981. (p. 36)

Tennessee Valley Authority. Energy Sourcebook - High School Unit. N.p.: Author, 1986.

_____. "How to Save on Your Electric Bills." N.p.: Author, 1984.

PLUGGING THE LEAKS

OBJECTIVES

The student will do the following:

1. Describe infiltration and identify locations where it is likely to occur.
2. Name several ways to stop infiltration.
3. Survey his/her home for drafts.
4. Explain how infiltration influences energy use.

SUBJECT:

Science

TIME:

90-135 minutes

MATERIALS:

pencil, tape, plastic food wrap, student sheets (included)

BACKGROUND INFORMATION

Winds or temperature differences can cause air to leak out of or into your house. This process is called infiltration. A certain amount of fresh air to replace the stale air caused by breathing, cooking, smoking, and other things is desirable and even necessary. Most houses, however, suffer from too much air infiltration. In a very "tight" house the air is replaced with outside air every one hundred and twenty minutes (two hours). In a leaky house the air may be replaced about every twenty minutes.

In winter, the colder it is outside, the more rapidly infiltration takes place. Inside air which you have paid to heat can leak out, and cold air from outside can leak in. In summer, hot outside air can get inside and cool air you have paid to air condition can leak out.

"Little" air leaks might not seem important, but numerous "little" leaks can have the same effect as one or two open windows. A sixteenth-inch crack around a door frame has about the same effect as a three-and-a-half-inch hole in the wall. Finding the small air leaks and sealing them, either on the inside or the outside of the house, prevents unnecessary air infiltration and results in energy and cost savings.

Terms

caulking: material that seals small cracks, joints, or seams to prevent air from leaking through.

draft: an air current in an enclosed space.

infiltration: the leaking of air through small openings into or out of a building.

weatherstripping: narrow pieces of insulating material used to cover or seal the cracks around windows and doors to prevent air from leaking through.

PROCEDURE

I. Setting the stage

- A. Ask the students if they know what it means when someone says "I feel a draft" or refers to a "drafty old house." Let several students explain these sayings in their own words.
- B. Explain what a draft is. Give the students a definition for the term infiltration if appropriate. Have several students go to the classroom windows (and exterior door, if the classroom has one) and put their hands near the joints; do they feel drafts?
- C. Ask the students how drafts affect the comfort of people inside drafty buildings. In winter, what effect does draftiness have? What is its effect in summer?
- D. Share the background information, as appropriate, with the students.
- E. Explain how infiltration increases energy use.

II. Activity

- A. Show the students a transparency made from the teacher sheet "CAULKING AND WEATHER-STRIPPING," included. Cover the labels on the sheet.
 1. Ask them if they know what these pictures show.
 2. Discuss the pictures with them, explaining what each picture shows.
- B. Give each student a copy of the student sheet "DRAFT-O-METER," included.
 1. Have each student make a draft-o-meter by following the instructions on the student sheet.
 2. Have the students check for drafts in the classroom.
- C. Give each student a copy of the student sheet "HOME DRAFT CHECK LIST," included. They are to use their draft-o-meters to check the locations listed on the sheet for drafts. As they survey their homes for drafts, they are to fill out the data chart on the student sheet.
- D. The next day, discuss the home draft check lists with the students. Have them suggest ways to stop infiltration in the locations in which it was detected.

III. Follow-up

Have the students answer the following questions:

- A. What are some places where infiltration is likely? (around windows and doors, cracks in walls and holes around pipes, exhaust fans and light fixtures, and so on)
- B. What can be done to prevent drafts? (Some possible answers include caulking around windows, weatherstripping around doors, filling cracks and holes with caulking or insulation, and so on.)

- C. Why are drafts an important energy consideration? (When drafts are not stopped, people tend to use more energy to keep their homes warm in winter and cool in summer. This is wasted energy. Stopping drafts saves energy, which saves money on energy bills, keeps us more comfortable, and helps conserve our energy resources.)

IV. Extension

- A. Have the students conduct investigations in the school, local businesses, or in homes, then recommend ways to decrease drafts and conserve energy.
- B. Invite a speaker from the local power company or a heating and cooling contracting business to discuss weatherizing houses and other buildings.

RESOURCES

National Appropriate Technology Assistance Service. Connections. A Curriculum in Appropriate Technology for 5th and 6th Grades. N.p.: U.S. Department of Energy, 1986. (Address: NATAS, P.O. Box 2525, Butte, MT 59702-2525. Telephone: 1-800-428-2525.)

The New York State Education Department and the New York State Energy Office. Energy Conservation Education for New York State: Interdisciplinary Learning Activities for Grades 7-12. N.p.: Author, n.d. (pp. 7-1,7-2)

Oak Ridge Associated Universities. "Is Your House Drafty?" Science Activities in Energy—Conservation Unit. Oak Ridge, TN: U.S. Department of Energy, n.d.

Smith, J. E. Conserve Energy and Save Money. New York: McGraw-Hill, 1981. (p. 30)

Tennessee Valley Authority. "How to Save on Your Electric Bills." N.p.: Author, 1984.

_____. TVA: A World of Resources. N.p.: Author, reprinted 1989.

CAULKING AND WEATHERSTRIPPING

CAULKING

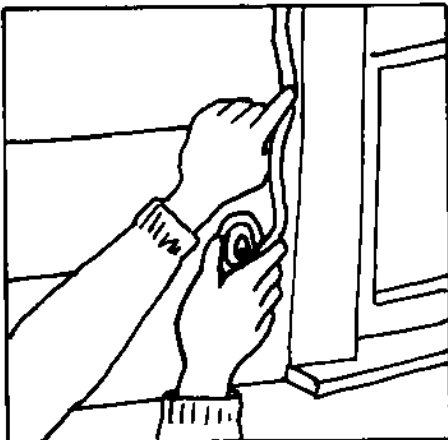
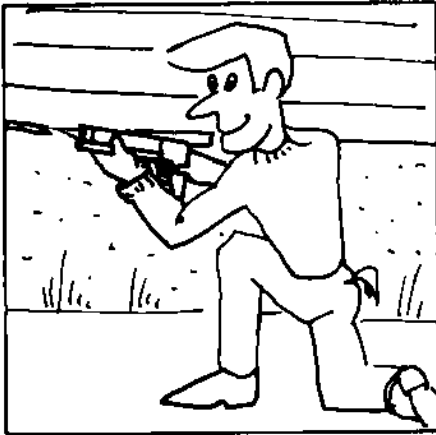
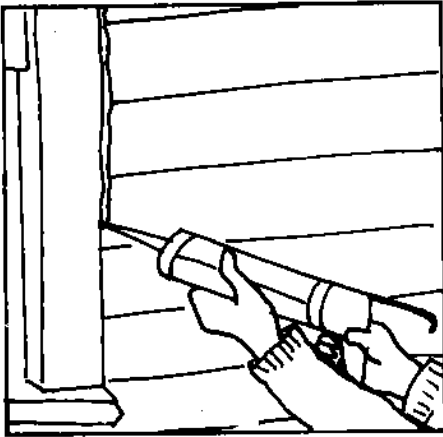

WEATHERSTRIPPING

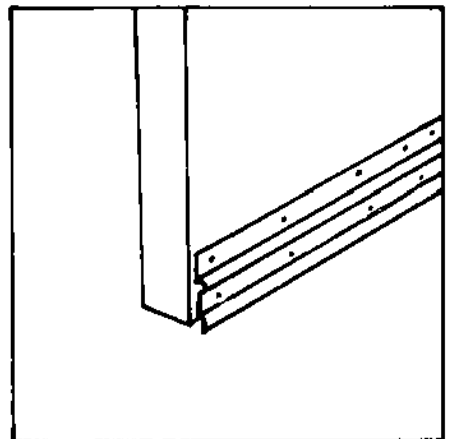
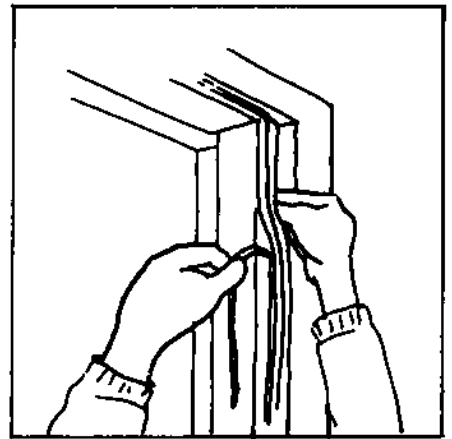
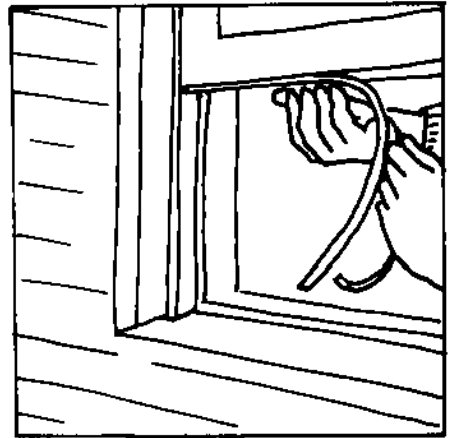

DRAFT-O-METER

Materials: pencil, tape, plastic food wrap

Cut a 12cm by 25cm strip of plastic food wrap. Tape the shorter edge of the wrap to a pencil and let the rest hang freely. Blow the plastic wrap gently and note how sensitive the wrap is to air movement. Drafts mean that air is leaking into or out of a building. This means either a loss of heat in winter or a loss of air conditioning in summer.

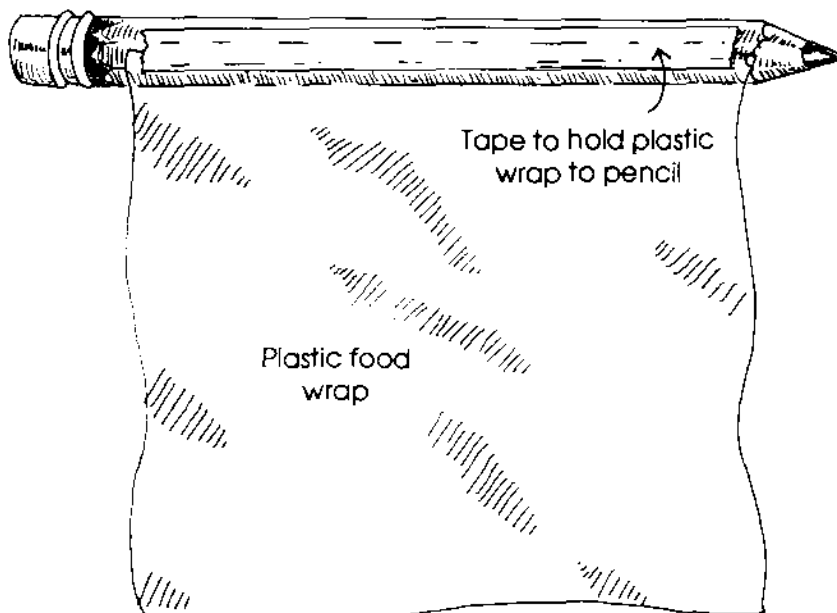

HOME DRAFT CHECK LIST

Check each of the locations where drafts are likely. Where your draft-o-meter detects drafts, rate them by checking the right column. Rate drafts as 1 (strong), 2 (moderate), or 3 (weak). If there is no draft, check the "no draft" column. If your home does not have a listed location, just draw a line through that location.

| DRAFT LOCATIONS | NO DRAFT | DRAFT RATINGS | | |
|--|----------|---------------|---|---|
| | | 1 | 2 | 3 |
| 1. Exhaust fans in bathrooms and kitchen | | | | |
| 2. Dampers in fireplaces and woodstoves | | | | |
| 3. Doors | | | | |
| 4. Windows | | | | |
| 5. Light fixtures attached to walls and ceilings | | | | |
| 6. Attic door | | | | |
| 7. Window air-conditioning units left in place in winter | | | | |
| 8. Mail chutes or slots in walls or doors | | | | |
| 9. Cracks in the foundation of the house or holes where pipes pass through | | | | |
| 10. Where porches and steps meet the house | | | | |

CONSERVING ENERGY AT SCHOOL

OBJECTIVES

The student will do the following:

1. Identify ways the school is wasting and conserving energy.
2. Suggest how the school can conserve more energy in the future.

SUBJECT:

Science

TIME:

90-135 minutes

MATERIALS:

teacher sheet (included), student sheet (included)

BACKGROUND INFORMATION

Schools use a tremendous amount of electricity. This is particularly true for those that are electrically heated and cooled. (Just think of the large area that must be heated or cooled.) Lighting is another major user. When all the electrical appliances and equipment necessary for day-to-day operations of a modern school are considered, it is easy to understand the increasing dependence of schools on electricity, even though electricity is a major budget item. Some schools have monthly electrical bills of thousands of dollars.

Some newer school buildings are energy-efficient, but many of the schools in the Tennessee Valley region are older and are not energy-efficient. Energy-saving buildings not only use less energy than wasteful buildings, but they are more comfortable.

Some key things in efforts to conserve energy at school are thermostat placement and setting, control of lighting, air vent location, and the number and operation of windows and exterior doors. Thermostats should be located on interior (rather than exterior) walls. They should be set on 68 degrees during the winter and 78 degrees during summer. Unused lighting should be turned off. Furniture arrangement should not block the flow of heated or cooled air from vents. Excessive windows and exterior doors are energy wasters, as are those that are too-often opened (while the building is being heated or cooled) or those that are left open. Of course, all unused electrical equipment and appliances should be turned off, but these are minor contributors to school energy bills when compared to heating, cooling, and lighting.

PROCEDURE

- I. Setting the stage
 - A. Share the background information, as appropriate, with the students, defining terms as necessary.
 - B. Prepare beforehand a transparency made from the teacher sheet "WHICH CLASSROOM IS CONSERVING?," included. Show the transparency to the students and explain its diagrams.

1. Ask the students the following questions:
 - a. Which classroom do you think is conserving energy? Why? (Classroom 1; thermostat is on inside wall, room has only two windows, and heating vent is not blocked)
 - b. Why is the other classroom wasting energy? (too many windows, thermostat on outside wall, and heating vent blocked by desks)
 - c. What can be done to make Classroom 2 more energy-efficient? (cover up some windows, rearrange desks so heating vent is not blocked)
 - d. Can you think of some other ways to conserve energy at school that are not shown on the diagram? (some possible answers include keeping heating units and filters clean; turn off lights, heating/cooling, and appliances when not needed; setting the thermostats correctly; and so on)
2. Discuss with the students why it is important to conserve energy at school. (Some points to discuss include the expense of energy and the need to stretch our remaining supplies of conventional energy resources.)

II. Activity

- A. Have the students conduct a school energy survey.
 1. Make or obtain a drawing of the school's layout. Divide the school into zones.
 2. Divide the students into groups and assign a zone to each group of students.
 3. Give each student a copy of the student sheet "IS ENERGY CONSERVED OR WASTED IN YOUR SCHOOL?," included. Discuss the eight items on the worksheet. Tell the students that if they observe energy being conserved in an area listed on the worksheet, they are to write a "1" in the blank beside "conserved." If they observe energy being wasted, they are to write a "1" in the blank beside "wasted." (This is assigning points for energy conservation or waste.)
 4. Have the students conduct the survey.
- B. When all of the eight items listed on the worksheet have been observed/recorded for each zone, have the students total the points they assigned and be ready to discuss the results of this survey.

III. Follow-up

- A. Have the students explain to the class what they found in their zones.
- B. Ask the students the following questions:
 1. Do you think our school can conserve more energy? How? (Possible answers include—turn off unnecessary lights; keep furniture from blocking heating/cooling vents; keep exterior doors closed in winter; keep heating/air conditioner filters cleaned; remodel the building to add carpet, decrease number of windows, lower ceilings, and place thermostats on inside walls.)

2. What can you do to help conserve energy at school? (Possible answers include—wear warm clothes in winter and cool clothes in summer; keep windows and doors closed when heat or air-conditioning are on; and keep unnecessary lights turned off.)
- C. Plan and organize an “Energy Week” for your school. Each grade level will be responsible for completing one of the energy conservation activities listed below:
1. Third Grade: Have the students draw pictures and write short paragraphs on energy conservation for a bulletin board display.
 2. Fourth Grade: Have the students create and present a short skit on energy conservation.
 3. Fifth Grade: Have the students help coordinate Energy Week. Have them “brainstorm” ideas about energy conservation and then compile their ideas into a presentation. Let some of the students visit other classes and do their presentations.

IV. Extension

- A. Have the students draw pictures of buildings designed to conserve energy. (Some features might be few windows on the north side, brick structure, and landscaping such as tall shrubs on the north side of the structure.)
- B. Have the students start a “Let’s Energize” campaign for the school. Have a school-wide poster contest. Display posters recommending good energy practices for the school.
- C. Have an assembly program in which the students may share the activities from Energy Week. Activities might also be shared at a parent/teacher organization meeting.

RESOURCES

The Energy Source Energy Education Program. Energy in American History. Lakewood, CA: Author, 1982.

McDonald’s Corporation. McDonald’s Ecology and Energy Action Pack. Oak Brook, IL: Author, 1977. (Address: Director-Corporate Responsibility, McDonald’s Corporation, One McDonald Plaza, Oak Brook, IL 60521.)

Tennessee Valley Authority. “How to Save on Your Electric Bills.” N.p.: Author, 1984.

WHICH CLASSROOM CONSERVES ENERGY?

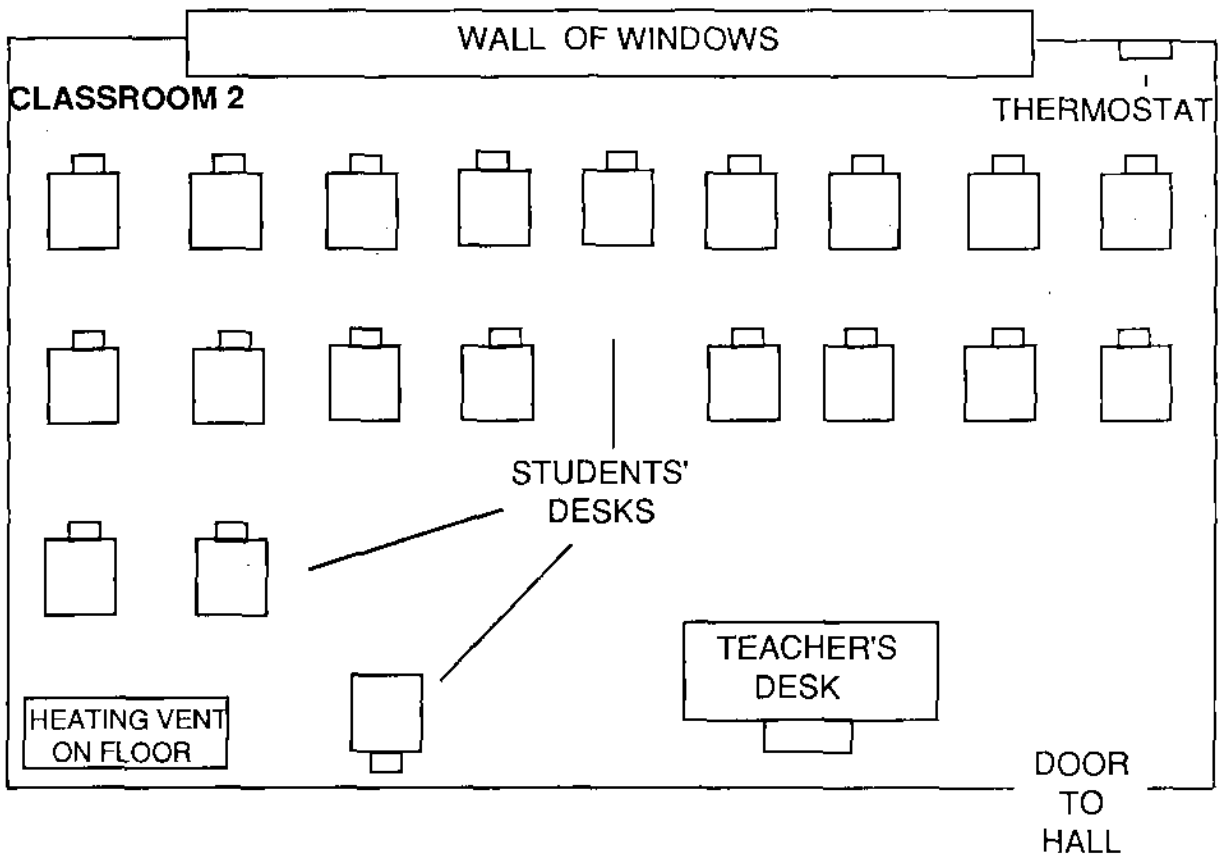
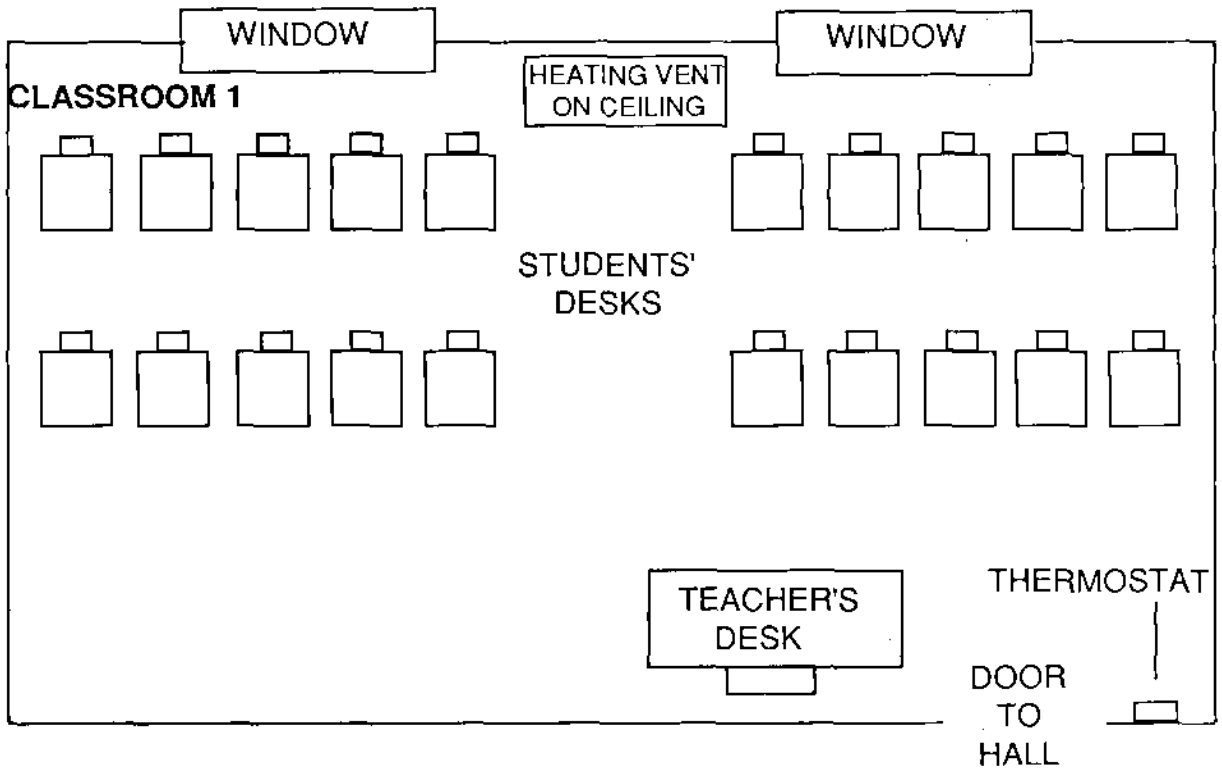

IS ENERGY CONSERVED OR WASTED IN YOUR SCHOOL?

Tour your school building to look for ways energy is conserved or wasted. There are eight things to observe as you walk through the building. If you think energy is being conserved, write the number "1" in the "conserved" blank. If you think energy is being wasted, write "1" in the "wasted" blank. Repeat this process in every room you check. When you finish your tour, count the points for each thing. Does your school save energy or waste energy?

| | |
|---|--|
| <p style="text-align: center;">Thermostat</p> <p>(Should be located on inside walls and set at 68° in winter or 78° in summer.)</p> <p>conserved: _____</p> <p>wasted: _____</p> | <p style="text-align: center;">Floor Covering</p> <p>(Carpeting helps keep rooms more comfortable.)</p> <p>conserved: _____</p> <p>wasted: _____</p> |
| <p style="text-align: center;">Ceiling Height</p> <p>(About 8 feet is average. Very high ceilings waste energy.)</p> <p>conserved: _____</p> <p>wasted: _____</p> | <p style="text-align: center;">Windows</p> <p>(Check for drafts and for numbers of windows.)</p> <p>conserved: _____</p> <p>wasted: _____</p> |
| <p style="text-align: center;">Classroom Air Vent Filters</p> <p>(Clean filters conserve energy. Dirty filters waste energy.)</p> <p>conserved: _____</p> <p>wasted: _____</p> | <p style="text-align: center;">Lighting</p> <p>(Unnecessary lights should be turned off.)</p> <p>conserved: _____</p> <p>wasted: _____</p> |
| <p style="text-align: center;">Exterior Doorways</p> <p>(Doors should be kept closed when heat or air conditioning is on.)</p> <p>conserved: _____</p> <p>wasted: _____</p> | <p style="text-align: center;">Furniture Placement</p> <p>(Furniture should not block heating or cooling vents.)</p> <p>conserved: _____</p> <p>wasted: _____</p> |
| <p>Total points: conserved _____</p> <p style="padding-left: 100px;">wasted _____</p> | |

ON THE ROAD AGAIN

OBJECTIVES

The student will do the following:

1. Identify factors that affect fuel consumption.
2. Compute the amount and cost of fuel for a given car traveling a given distance.
3. Project the effects of the price of gasoline on driving habits.

SUBJECT:

Science, Math

TIME:

100 minutes

MATERIALS:

pictures of large and small cars, graph paper, models of late-model and older cars, yellow crayons or markers, student sheet (included)

BACKGROUND INFORMATION

The United States uses about one third of the world's energy. About one fourth of that energy is used for transportation. We own more private vehicles than any other nation. They run on gasoline or diesel fuel made from petroleum. About half of the Nation's supply of petroleum is imported from foreign countries. The heavy use of private automobiles is the main reason for our dependence on foreign oil.

It is essential that we consume less gasoline (and diesel fuel). There are several factors which affect automobile fuel economy. Some of them you can control; others you cannot. The most important factor affecting gas mileage is the kind of car one drives. The car's weight and engine size determine much of its fuel economy. The way a car is driven can sometimes have a greater effect on fuel economy than its weight or engine size. Driving at high speeds, jack-rabbit starts, allowing the engine to idle for more than a minute or so, and driving at excessively variable speeds (as opposed to maintaining as constant a speed as possible) greatly increase fuel consumption. Keeping a vehicle in top running condition helps conserve fuel. Changing the oil regularly, keeping the engine tuned up, and keeping the tires properly inflated can help maximize fuel economy.

Some factors affecting gas mileage cannot be controlled. Stop and go traffic—characteristic of urban areas—lowers mileage. The same is true of bad road conditions. Although these and other factors cannot be controlled, we can lessen some of their impact by planning and by altering our habits.

Planning trips can save significant amounts of fuel. Several short trips can be combined into one major one; this also saves time. Errands and shopping can be planned so that all stops are in the same general area rather than spread out in several different directions. Long trips (such as vacations) may be exchanged for shorter ones. Here in the Tennessee Valley region there are many recreation opportunities within short distances of most communities. Sharing rides to work, school, and other activities can be beneficial economically and otherwise. Like carpooling, the use of public transportation helps save fuel and money and reduces the number of private vehicles using the roads. Finally, walking or riding a bicycle when possible are the ultimate fuel conservers—they use only one's own energy.

PROCEDURE

I. Setting the stage

- A. Collect pictures of small and large cars and show them to the class. Ask the students the following questions:
 - 1. Which car will get more miles per gallon of gasoline? Why? (most likely the smaller car, because of its size and weight)
 - 2. What are some other things that might affect gas mileage? (Answers may include how cars are driven, road conditions, and how cars are maintained.)
- B. Have the students bring in model cars; ask them to bring models of both past and present designs so that changes in car designs can be observed. Discuss such changes in design as body shape. Ask the students if they think changes in design can make cars more or less energy-efficient.

II. Activity

- A. Give each student a copy of the student sheet "TRANSPORTATION ENERGY QUIZ," included. Tell them to use yellow crayons to shade in the squares that state ways to save energy. (Blocks 1, 3, 4, 6, 8, 10, 11, 12, 13, 14, and 15 should be shaded.)
- B. Divide the students into small groups. Allow each group to choose a particular car or truck for which they will determine fuel use and cost for a trip of given length. For example, you might have each group calculate how many gallons of gasoline and how much money it would take to drive to and from school if they started from the county courthouse.
 - 1. Have the students use advertisements, automotive magazines, or actual window stickers of vehicles on sales lots to determine the fuel economies (mpg) of the vehicles they have chosen.
 - 2. Have the students find the current typical price of gasoline in the area.
 - 3. Give the students the number of miles to be driven.
 - 4. Have the students divide the miles to be driven by the fuel economy (mpg) of the vehicles they chose to find the number of gallons of gas needed for each trip (trip miles \div mpg = gal needed).
 - 5. Have the students multiply the number of gallons of gas needed by the current price of gas to determine the cost of driving the trip (gal needed \times cost per gal = cost per trip).
 - 6. Write on the board each group's chosen vehicle, its fuel economy rating, and the cost of the trip. Discuss with the students how the different vehicles compare.
- C. Have the students select a city in the United States and use reference books or maps to determine its distance from your city. Have each student calculate the fuel cost from where they live to the city of their choice using the fuel economy and price information they used in B. (above). When the calculations are complete, again compare their results.

- D. Have the students talk with their parents about their family cars. They are to find out an estimate of car use for a year and an estimate of car fuel economy. (For example, a family might drive 15,000 miles a year in a car that averages 30 miles per gallon.)
1. Have the students use these figures and the typical cost of fuel in the area to determine the annual fuel cost for their families. (Divide the number of miles driven each year by the number of miles per gallon the car gets, then multiply the quotient by the cost per gallon.)
 2. Since fuel costs fluctuate, have the students recalculate annual fuel costs using several other (hypothetical) per gallon costs. You may wish to use a wide range of figures and discuss with the students some possible results of drastic changes in fuel costs. For example, what do the students think might happen if the cost of gasoline doubled?

III. Follow-up

- A. Have the students draw and label pictures of five things that affect the amount of energy used by an automobile. (Possible answers include tire pressure, road conditions, weather, accessories, speed, trip length, and so on.)
- B. Have the students write a paragraph describing how the layout of a town can affect gas consumption and how the town's layout could be improved to save energy.
- C. Have each student write a paragraph describing how he/she would make efforts to conserve energy as a driver. He/she should describe the kind of car he/she would choose, how he/she would maintain the car, how he/she would drive, and other factors that would help him/her conserve gasoline.

IV. Extension

- A. Have the students make posters about driving and energy conservation.
- B. Have the students develop print advertisements for energy-efficient vehicles.
- C. Have the students estimate the number of cars owned by the families of the students in the class. Using 15,000 miles as average annual mileage per car and the fuel economy and price data used in II. (above), have them calculate an estimated total annual expenditure for fuel by all the families represented in the class.

RESOURCES

Industry: People and the Machine, "Part 2: Wheels for America - The Automobile Industry." Boston, MA: Allyn and Bacon, 1975. (p. 81)

National Geographic. (A Special Report in the Public Interest) Energy: Facing Up To The Problem. Getting Down To Solutions. Washington, DC: Author, 1981.

The New York State Education Department and the New York State Energy Office. Energy Conservation Education for New York State : Interdisciplinary Learning Activities for Grades 7 - 12. N.p.: Authors, n.d.

Smith, J. E. Conserve Energy and Save Money. New York: McGraw-Hill, 1981. (pp. 80-84)

TRANSPORTATION ENERGY QUIZ

Use a yellow crayon to shade in each square that states a way to conserve energy.

| | | |
|---|--|---|
| 1. Combine short trips. | 2. Buy a large car. | 3. Buy a small car. |
| 4. Share rides (join a carpool). | 5. Never check the tires' air pressure. | 6. Use a bicycle or walk when possible. |
| 7. Take very long trips. | 8. Keep the proper amount of air in the tires. | 9. Drive 70 mph. |
| 10. Use the car's air-conditioner only when needed. | 11. Have only one car. | 12. Drive 55 mph. |
| 13. Change the car's oil regularly. | 14. Vacation close to home. | 15. Drive at a steady pace. |

AGAIN AND AGAIN

OBJECTIVES

The student will do the following:

1. List ways to conserve and recycle paper.
2. Determine the amount of material discarded by the class and calculate the average amount of waste per student.
3. Collect recyclable materials and take them to a recycling facility.

SUBJECT:

Science, Math

TIME:

250 minutes, plus a field trip

MATERIALS:

scales, garbage bags, posterboard, crayons or markers, teacher sheet (included)

BACKGROUND INFORMATION

Many of the materials we use and throw away each day could be recycled to help conserve raw materials and energy and lessen pollution and waste disposal problems. To recycle a waste material is to separate it from other waste materials and process it so that it can be used again in a form similar to or the same as its original use. For example, aluminum beverage cans can easily be remade into new cans. Glass can be remade into bottles, jars, and other items. Newspapers can be recycled into cardboard or other materials.

The vast amount of paper used in our Nation and its familiarity in each of our lives makes paper a particularly appropriate material to examine from a recycling perspective. Paper uses of all kinds can be divided among all Americans so that it can be said that each of us uses about 600 pounds of paper per year (many times what citizens of other countries use). About three-fourths of this is thrown away, and about half the volume of urban solid waste is paper; this requires much space and effort to dispose of. Only about a fourth of our paper is recycled, even though paper is fairly easy to recycle.

Recycling paper would save forest resources and produce 95 percent less pollution than making paper from trees. It would save 30 to 55 percent of the energy required to make paper from trees. If only half the paper discarded in our Nation each year were recycled, the energy savings would be equal to the electricity used by 10 million people in a year. Recycling can be a significant factor in our energy conservation efforts.

Term

recycle: to separate a waste material from other wastes and process it so that it can be used again in a form similar to or the same as its original use.

PROCEDURE

I. Setting the stage

A. Discuss recycling with the students.

1. Share the background information on recycling with the students. Ask the students to name some recyclable materials with which they are familiar.
2. Have the students think about the amount of paper they use each day at school. Have them estimate the number of sheets of paper they use daily.

B. Invite someone to speak to your class about recycling and its importance. Recyclers, solid waste engineers, county health officials, city commissioners, planning officials, or environmental group representatives may be available to share with your students. (Try to find someone who has experience speaking to groups of children.)

II. Activity

A. Have the students discuss ways to conserve paper at school or at home. Lead them into a discussion about paper recycling. Have the students speculate as to how paper is treated in order to recycle it. (Ask if anyone knows how paper is made from trees. This could be a hint as to how it is recycled.)

B. Have the students guess how much paper the class will use in one week. Have them collect and weigh (in garbage bags) the paper in your class wastebasket each day for one week. (How close were their guesses?) Have the students divide the total weight of the week's trash by five days and then by the number of students to determine the average amount of waste paper generated by each student per day.

C. Have the class collect recyclable materials, then take the class on a field trip to a recycling center for a tour of the facility. Take the recyclables the class collected and sell them to the center.

III. Follow-up

A. Have each student make a list of ways in which he/she can better conserve and recycle paper. Then compile the lists to make one major proposal. The students should then make posters to be shared with the other classes.

B. Have the students make graphs or tables showing the amounts of trash generated by the class each day for a week. (Both recyclable and nonrecyclable materials may be included.)

IV. Extension

A. Have the students survey the county (or surrounding counties) to identify commercial and nonprofit recycling centers. (They might start by checking the telephone book.) They should ask what is recycled and what the current cash prices for materials are. The students should then prepare a brochure or pamphlet. Submit the brochure to the community newspaper or school newsletter for publication.

- B. As a class project, make several sheets of recycled paper from waste paper. Have the class write a newsletter on recycling on the paper you made. Directions for making paper are given on the teacher sheet "MAKING PAPER," included.
- C. Have the students conduct a paper drive at school and collect paper to be recycled. (Suggestion: You may want to ask for the principal's or PTA's help in organizing the effort. Perhaps they could sponsor the drive or supply a dumpster or other collection container.)

RESOURCES

Alabama Environmental Quality Association. Recycling: Unburied Treasure. Montgomery, AL: EnviroSouth, Inc., 1981. (Address: P. O. Box 11468, Montgomery, AL 36111.)

The Center for Environmental Research and Service. Alabama PALS: People Against A Littered State (Litter Education Activity Guide). Troy, AL: Author, n.d. (Telephone: 205-566-4424.)

McDonald's Corporation. Ecology and Energy Action Pack. Oak Brook, IL: Author, 1977. (Address: Director-Corporate Responsibility, One McDonald Plaza, Oak Brook, IL 60521.) (p. 7)

Miller, G. T., Jr. Environmental Science: An Introduction. Belmont, CA: Wadsworth, 1986.

Tennessee Valley Authority. Waste: A Hidden Resource. N.p.: Author, 1989.

MAKING PAPER

Materials: large tub, dishpan, or sink; 2 wooden frames (same size; one with fine wire screening); blender; blotters (multiple layers of cotton, felt squares, or layers of paper toweling); rolling pin; iron; bleach (optional); colorant (optional); sponges; gelatin, acrylic spray, or instant starch (optional); waste paper

Terms

Couching - Taking a new sheet of paper from the mold and allowing it to adhere to a blotter.

Deckle - A frame (like a picture frame) that fits over the mold.

Mold - A frame covered with a woven material or screening; works like a sieve.

Pulp - The ground-up material, moistened with water, from which paper is made.

Sizing - A substance added to give paper a certain surface or finish.

Slurry - Pulp mixed with enough water to make a liquid.

Wet leaf - The newly formed sheet of paper (before it is dried).

Gather Materials and Equipment

1. Pulp Materials:
 - a. Recycle paper of all kinds—old mail, note paper, brown bags, newspaper, paper towels, and tissue paper. (You should use less of the last four kinds because of the brown or gray tint and the weakness of paper made from them. The higher the quality of the paper recycled, the higher the quality of the paper produced.)
 - b. You may want to experiment with other plant fibers, such as weeds, leaves, grasses, vegetable peels, vines, sawdust, cornhusks, straw, and cloth. Try cutting up a bit of colored cotton cloth for a tint. If you use these, cut up all the materials into bits and put them in the blender with plenty of water. Experiment with various materials until you get a type of paper you like.
2. Use an old blender for mixing the prepared pulp with water to make slurry. (Be sure to use enough water so that the blender motor will not be damaged.)
3. Make the mold and deckle from two rectangular wooden frames of the same size. (These should be about the size of the sheets.) Staple fine screen on one frame for the mold. The empty frame is the deckle. The mold and deckle can also be made using two pans. Cut out the bottom of one pan, leaving a ledge to hold the screening. Cut the entire bottom out of the other pan to make the deckle.
4. You will need a large container for the slurry and some sponges, cloths, or other absorbent materials.
5. Use cloth pads for blotters (to absorb water from the newly made paper). Cotton cloth is good for couching the sheet. Felt squares, which can be wrung out and reused, are also excellent. Paper towels or stacks of newspaper may be used, but the newspaper should not be placed directly against the sheet of new paper, since it may leave print on it.

MAKING PAPER

(continued)

6. A rolling pin or a large, heavy, round jar will be useful to press excess water out of the paper.
7. An iron is useful for faster drying of the sheets (although the paper can be allowed to air dry).
8. You may choose to use one or more of these optional materials to help in producing a better quality of paper:
 - a. Bleaching agents such as laundry bleach or detergent, which help remove ink from newspaper.
 - b. "Sizing" materials such as liquid instant starch, clear gelatin, or clear acrylic spray.
 - c. Coloring materials (natural or synthetic) such as fabric dyes, food coloring, or even a small amount of colored, water-based, latex paint.

Make the Paper

1. Fill the blender about three-fourths full with water. Add the shredded paper (and perhaps other fibers). A bleaching agent may be added at this stage. One tablespoon of starch for every two cups of water may be added for sizing. If colored paper is desired, add dye (diluted with water) to the mixture. You may add a tablespoon of colored latex paint instead. Blend until the mixture is finely ground and smooth.
2. Hold the mold so the screen side is up. Place the deckle on top of the mold.
3. Pour the slurry from the blender into the dishpan. Stir it to keep the particles from settling out. Holding the mold and deckle firmly, scoop them down and under the water. Hold them level as you once again stir the slurry (to get an even distribution on the screen). Avoid touching the screen since it will cause matting of the particles. Gently shake the frames from side to side, and in one motion, lift the frames out of the slurry. Keep them level at all times. Keep them over the dishpan. The water will run through the screen and leave a thin layer of pulp (the "wet leaf") on the screen.

If the pulp is not smooth and even, the paper will not be either. Wash off the screen and dip again until you get a good "wet leaf." This takes some practice.

Finally, allow the mold and deckle to shed the excess water. Once most of the water has dripped through, you may turn them vertically to drain. The "wet leaf" will not slide off. (Water dripping on the "wet leaf" will leave water marks, however.)

4. Set the mold and deckle on a pad of dry cloths or paper towels. Remove the deckle. Place a blotter of cotton cloths or paper towels over the wet leaf and smooth gently. Then turn the frame and blotter over (face down) on the table.
5. Sponge excess water from the screen. Then carefully remove the mold. If done correctly, the sheet will adhere to the blotter.
6. Place more blotters on top of the new sheet. You may now use a rolling pin to squeeze out any excess water. Felt cloths placed on top and wrung out each time work well.

MAKING PAPER

(continued)

7. Now you may decorate the paper by either of these optional techniques:
 - a. Brush a diluted dye solution on the damp sheet for a water color effect.
 - b. Imprint a leaf, twig, or or some other design by pressing it into the sheet. Remove it when the imprint is made.
8. When the paper has been blotted thoroughly, iron the sheet between several sheets of paper or cloth. Use the cotton setting on the iron.

Finishing the Sheet (Optional)

1. After being ironed, the sheet may be sprayed with a clear acrylic spray. Allow this to dry thoroughly.
2. You may wait a day or two and press the sheet directly (with no cloth or paper covering it) with the iron for a glossy surface.
3. You may "size" your paper with gelatin. Heat one and a half ounces of clear gelatin with one pint of water. Pour the dissolved gelatin and water into a dishpan. Add a pint of cold water to the mixture. Slide a sheet of dry handmade paper quickly into and out of the sizing mixture. Blot it and press it dry with an iron. This will make the paper less absorbent.
4. You may further decorate the paper with silkscreening or block printing.

Make a Matching Envelope

1. Choose a ready-made envelope of the size and shape you wish to make. Separate its glued seams and spread it out flat.
2. Use it as a pattern by laying it down on a sheet of the homemade paper and tracing it.
3. Cut the traced pattern out of the sheet. Fold it to match the original envelope and glue it together at the seams.

HOW MANY? HOW MUCH?

OBJECTIVES

The student will do the following:

1. Represent population growth at a given rate.
2. List some effects of population growth on the consumption of resources.
3. Explain the importance of resource conservation in light of increasing population.

SUBJECTS:

Science, Math

TIME:

45-60 minutes

MATERIAL:

(one per student or group)
small boxes or bags of buttons,
beans, or other tokens; student
sheet (included)

BACKGROUND INFORMATION

The planet on which we live provides an incredibly rich supply of the resources on which we thrive. All the things we use and/or consume each day originate in the earth. The only thing we must have that comes from elsewhere is sunshine. Its warmth and light are essential for life on the planet. Everything else is available in limited amounts—though vast, limited.

As the human population increases, we demand increasing amounts of the resources we need from the earth. If the supplies of resources are finite, we must realize that we cannot continue to demand ever-increasing amounts of them.

Resource conservation is the wise and efficient use of the supplies of things we require, need, or want. The world's population is now over five billion people. Our demands are also increasing. With demand as well as population increasing, conservation is necessary to help extend our limited supplies of resources.

Term

conservation: the wise and efficient use of resources.

PROCEDURE

- I. Setting the stage
 - A. Have the students list some things they need each day. Write their answers on the board. Be sure they have listed space to live, shelter, food, water, air, clothing, and energy.
 - B. Discuss with the students what would happen in their homes if, for example, in an emergency, their families had to share all their daily necessities with another family. (Assume that extra supplies could not be obtained.) Lead the students to think about how curbing waste, eliminating nonessential uses, and creatively using resources would "stretch" their supplies.
 - C. Give the students the definition of conservation and discuss it with them.

II. Activity

- A. Give to each student (or group of students) a copy of the student sheet "COMMUNITY GROWTH" (included) and a small box or bag containing approximately 100 buttons, beans, or other tokens.
 1. Explain that this grid represents a place and all the natural resources it has. Each square represents the resources—food, water, fuel, and raw materials from which to make shelter, clothing, and other necessities—that a family needs.
 2. Tell the students that by placing tokens in the squares, they will represent people coming to this place and using the resources the squares represent.
- B. Have the students begin populating the area and consuming resources.
 1. Have the students pretend that two families move to the community. They are to place a button in each of two squares. This means that two families are now consuming the resources they need.
 2. Have the students pretend that the next year, the number of families living in the community doubles (so that there are 2×2 families). If the number of families doubles each year, how many years will it take until the community is filled to capacity? (six years) (Have the students use their tokens to fill the grid, counting out each doubling.)
 3. Have the students pretend that at the end of six years, eight of the families decide to share one-half of their resources (squares) with other families. How many families are there now? (76) (Have the students put another token in each of eight squares.)
 4. Ask the students what can be said about the resources available to the 16 families that share the resources of eight families. Do they have more resources or fewer resources than the other families? (fewer) What if another family came to each space already shared by two families? (Each one of the 24 families would have even fewer resources to use.)
 5. What can the students conclude about the resources available to each family (or person, or—on a larger scale—community or nation) as population increases drastically (for example, doubling or tripling)? (Each one has fewer resources to use.)
- C. Discuss the background information with the students. Stress that conserving resources of all kinds helps to ensure that as our population increases, we can still have the resources we need.

III. Follow-up

- A. Have the students draw pictures that show the effects of an increasing population. Under each picture, the students should write a sentence explaining what conservation steps need to be taken to address the situation pictured.
- B. Have the students write a creative story about what would happen to their community's energy resources if its population doubled in five years. The story should include some conservation steps that could be taken to alleviate these problems.
- C. Have the students imagine that their school has exactly enough food, water, energy, and space to provide for each student in the school and imagine that the size of the school's supplies of food, water, energy, and space cannot increase. What would be some of the problems the school and individual students would encounter as a school year progressed?

IV. Extension

Share the following information with the students:

The population of the United States has increased dramatically over the years. In 1790, there were almost four million people. By 1980, the population of the United States had increased to over two hundred and twenty-six million people. As of 1987, the population is estimated to be over two hundred and forty-two million people. The table below shows the population growth of the United States for the years 1900 to 1980.

| YEAR | POPULATION |
|------|-------------|
| 1900 | 76,212,168 |
| 1910 | 92,228,496 |
| 1920 | 106,021,537 |
| 1930 | 123,202,624 |
| 1940 | 132,164,569 |
| 1950 | 151,325,798 |
| 1960 | 179,323,175 |
| 1970 | 203,302,031 |
| 1980 | 226,542,580 |

- Have the students make a graph of U.S. population growth in this century using the populations given above.
- The population of the United States almost doubled between 1900 and 1950. By the mid-1980s, however, the growth rate had decreased to a rate classified as "slow"; it will now take almost 100 years for our population to double (provided the growth rate remains where it is now). Have the students multiply the 1980 population by two to project the U.S. population in about 2080.
- Have the students write "science fiction" stories about possible lifestyles and events in about 100 years. How do they think life will be different? the same?

RESOURCES

The Energy Source Energy Education Program. Energy in American History. Lakewood, CA: Author, 1982. (p.14)

Holt Science. New York: Holt, Rinehart, and Winston, 1984. (p. T-258)

Miller, G. T., Jr. Environmental Science: An Introduction. Belmont, CA: Wadsworth, 1986.

COMMUNITY GROWTH

| | | | | | |
|--|--|--|--|--|--|
| | | | | | |
| | | | | | |
| | | | | | |
| | | | | | |
| | | | | | |
| | | | | | |
| | | | | | |
| | | | | | |
| | | | | | |
| | | | | | |

GLOSSARY

appliance: an instrument or device designed for household use especially operated by electricity.

caulking: material that seals small cracks, joints, or seams to prevent air from leaking through.

conservation: the wise and efficient use of resources (e.g., energy resources).

draft: an air current in an enclosed space.

energy: the ability to do work.

infiltration: the leaking of air through small openings into or out of a building.

labor-saving devices: devices developed to decrease or replace human labor, especially manual labor.

lifestyle: the way of life which is characteristic of an individual or a group of people.

recycle: to separate a waste material from other wastes and process it so that it can be used again in a form similar to or the same as its original use.

standard of living: the degree or level of material well-being of an individual or group.

weatherstripping: narrow pieces of insulating material used to cover or seal the cracks around windows and doors to prevent air from leaking through.

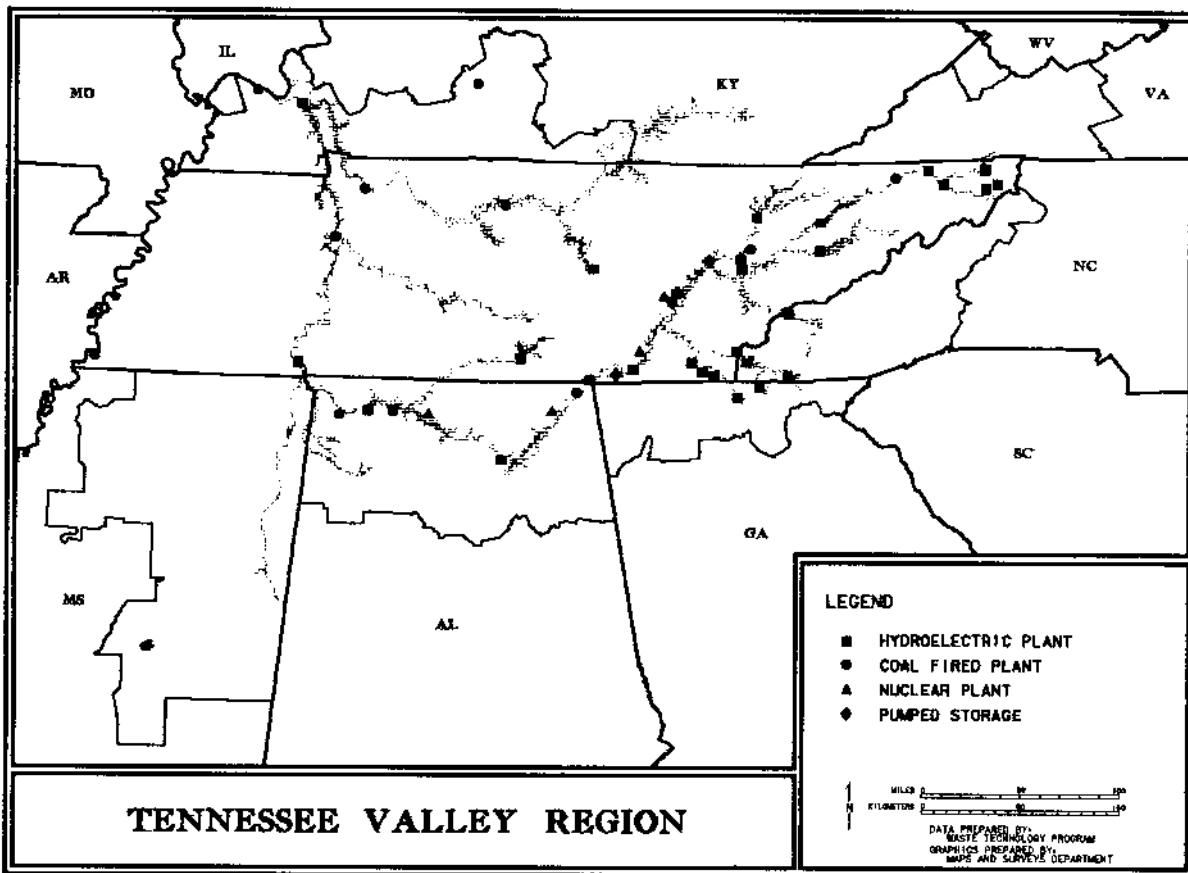

DOWN IN THE VALLEY

OBJECTIVES

The student will do the following:

1. Draw a map to illustrate the location of the Tennessee River Valley.
2. Design landform symbols and place them appropriately on a map of the Tennessee River Valley region.
3. Locate on a map where he or she lives in the Tennessee River Valley region.

SUBJECTS:

Geography, Art

TIME:

90 - 120 minutes

MATERIALS:

large U.S. map, overhead projector, bulletin board paper, colored markers, construction paper, transparency (master included)

BACKGROUND INFORMATION

The Tennessee River Valley is located in the central southeastern region of the United States. The area includes parts of seven states. The river system begins in the southern Appalachians near the western end of Virginia and sweeps southwestward in a wide arc across western North Carolina and eastern Tennessee, northern Georgia, and northern Alabama, turning northward across the northeastern corner of Mississippi. It continues northward across western Tennessee and Kentucky and finally flows into the Ohio River at Paducah, Kentucky. Before dams were built, the Tennessee River was characterized by hazardous shoals, seasonal variations in depth, and abrupt changes in gradient.

The landforms in this region include mountains and ridges in the east, hills and plateaus in the central section, and rolling hills and plains in the western section.

Terms

drainage basin: the land area that contributes water to a stream.

landform: a naturally formed feature of the terrain, such as a mountain, valley, or plateau.

legend: a chart explaining the symbols or illustrations used on a map.

plateau: an elevated expanse of relatively level land.

river valley: the extensive land area drained by a river system.

tributary: a stream that flows into a larger stream.

PROCEDURE

I. Setting the stage

- A. Show the students a map of the United States. Ask the students the following questions:
1. In what section of the United States is the state of Tennessee?
 2. Where is the Tennessee River located? (See the drawing in II.A. of this activity.) Have a student locate Tennessee and the Tennessee River on the map.
 3. Find all the tributaries of the Tennessee River. What states are included in the area of the Tennessee River and its tributaries? (Tennessee, North Carolina, Georgia, Alabama, Mississippi, Kentucky, and Virginia)
- B. Share with the students the following information: The Tennessee River and its tributaries drain most of Tennessee and parts of Virginia, North Carolina, Georgia, Alabama, Mississippi, and Kentucky. This area includes landforms such as mountains, plateaus, rolling hills, valleys, and plains.

II. Activity

- A. Draw the outline of the state of Tennessee and its surrounding states. Include the Tennessee River and its major tributaries.
1. Cover the bulletin board in white paper. Using the included master, make a transparency so that the map may be projected onto the bulletin board. Have the students trace the borders of Tennessee and the surrounding states with the markers.
 2. Have the students write the names of the states on the map.
 3. Have the students trace the Tennessee River and its major tributaries on the map with blue markers.
- B. Use the map drawn on the bulletin board in Activity A. (or make a new bulletin board map). Discuss with the students the different landforms found within this region. Eastern areas include mountains, ridges, and valleys. (Many of the rivers originate as mountain streams in this area.) Central areas include plateaus and hills. Western areas include rolling hills and plains. Write these terms on the board—mountains, ridges and valleys, rolling hills, plateaus, hills, plains.
1. Divide the students into groups and have each group make from construction paper multiple copies of a symbol representing a landform. Allow the student groups to design and make their own symbols. Symbols might resemble the following:



MOUNTAINS



PLATEAUS



RIDGES AND VALLEYS

HILLS

ROLLING HILLS

PLAINS

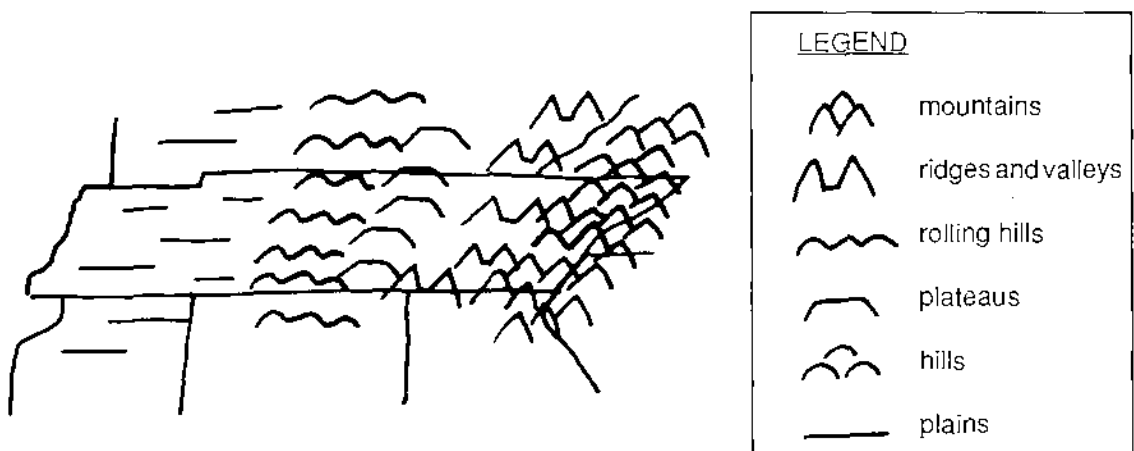
2. While discussing with the students the areas of the region where these landforms are found, have them attach the symbols to the bulletin board map used in Activity A. Make a legend for the map. The finished map might resemble this:



C. Use the bulletin board map made in Activities A. and B.

1. Tell the students that we are going back in time to the late 1700s and will take a trip through the mountains from Virginia to where we live now. We will be traveling by river in small canoes as much as is possible. (The students will need some background information on what the rivers were like in this area during the 1700s. See the background information at the beginning of the activity.)
2. On the bulletin board map, have the students locate, in Virginia, a starting point for the trip. Have them locate the place where they live (the destination for the trip).
3. With the students, examine the areas through which we will travel (they could trace the route on the bulletin board map). Help them estimate how long the trip will take. Divide the students into groups and have each group make a supply list for the journey. When they are finished, discuss the supplies they listed. They will need to eliminate supply items that were not available in the 1700s and substitute things that were available.
4. Take the imaginary trip. Suggestions: Students might take turns describing sections of the trip. Assign various aspects of the trip (clothing, food, shelter) to different groups of students and, as the trip progresses, have them explain what happens in terms of those aspects. The students could write stories about taking the trip or make drawings illustrating sections of the trip.

III. Follow-up

Use the following questions as discussion (you may want to display the map during the discussion):

- A. In what area of the United States is the Tennessee River Valley located? (southeast)
- B. What states are located in the Tennessee River Valley region? (TN, KY, VA, NC, GA, AL, MS)
- C. What different landforms are located in the eastern part of this region? (mountains, ridges, valleys) central part? (plateaus and hills) western part? (rolling hills and plains)
- D. In what area of the Tennessee River Valley do you live? (Answers will vary.)

IV. Extension

- A. Use an open-ended question for discussion or an essay-writing exercise for the students: Using what you know about the Tennessee River Valley and its landforms, in what area of this region would you most like to live? Explain your answer.
- B. Have the students describe a modern-day trip down the Tennessee River in terms of what they might encounter and the supplies and equipment they would need.

RESOURCES

Billings, H. All Down the Valley. New York: The Viking Press, 1952. (pp. 9-12)

Hodge, C.L. The Tennessee Valley Authority: A National Experiment in Regionalism. New York: Russell & Russell, 1968.

McCarthy, D.M., and C.W. Voigtlander, eds. The First Fifty Years: Changed Land, Changed Lives. Knoxville, TN: Tennessee Valley Authority, 1983.

The Oregon Trail. MEC 5001A (Apple II, 64K). Computer software. (Grades 5 and up) Worthing, OH: Sheridan and Associates, n.d. (Cost: \$49. Address: William K. Sheridan & Associates, 1606 Tennyson Court, Worthington, OH 43085.)

Tennessee Valley Authority. Navigation on the Tennessee River. Video tape. (Time 13:19.) On loan from TVA-University Network Environmental Education Centers.

MAP OF THE TENNESSEE RIVER VALLEY

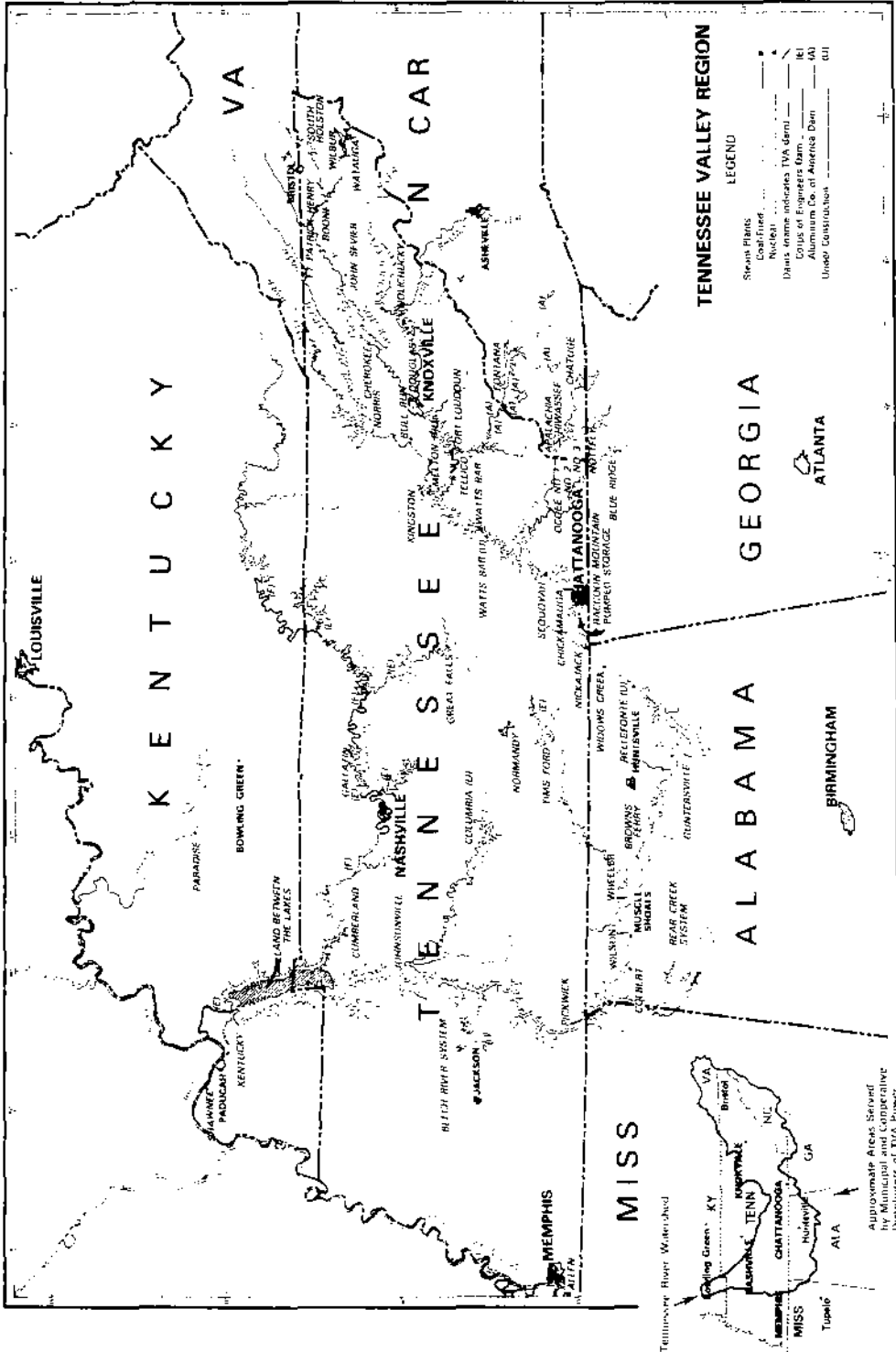

RESOURCE—FULL

OBJECTIVES

The student will do the following:

1. Identify and locate important natural resources of the region on a map of the Tennessee River Valley.
2. Make a relief map of the region and describe the effect of water flow on the soil of the Tennessee River Valley.
3. Explain the importance of conserving essential natural resources.

SUBJECTS:

Science, Geography, Art

TIME:

150-250 minutes

MATERIALS:

overhead projector, aluminum oven liner, grease pencil, soil, dough-clay (1 c. flour, 1/2 c. salt, 1 T. oil, 1 c. water, 2 t. cream of tartar), watering can (sprinkler), construction paper, poster board, video camera (optional), map of Tennessee River Valley region from activity "Down In The Valley"

BACKGROUND INFORMATION

The Tennessee River Valley region is rich in natural resources. It has abundant water (rivers), fertile soil, and extensive forests. There is also oil, coal, copper, iron ore, zinc, asphalt, barite, clay, limestone, manganese, marble, bauxite, phosphate rock, slate, chromium, nickel, lead, sand, and gravel.

In the past, resources such as soils and forests were mismanaged, and mining was done without regard for its environmental effects. Today, people are more concerned about these resources. Because of our rich supplies of natural resources and our concern for managing them well, the future looks brighter for economic progress. Citizens need to be aware of these issues in order to ensure continued economic growth in the Tennessee River Valley region.

Terms

natural resource: something from nature that people need or want, such as water, coal, soil, forests, and beauty.

nonrenewable: not able to be restored or replenished.

reforestation: the planting of trees to replace trees that have been destroyed or harvested.

renewable: able to be restored, replaced, or replenished.

resource: a supply of a valuable or useful thing; something that can be used to make or supply something else.

soil erosion: the loss of soil due to washing away (by water) or blowing away (by wind).

PROCEDURE

I. Setting the stage

- A. Display a map of the Tennessee River Valley region and its landforms, or project the map of the region for which a transparency master is included (in the previous activity) onto the bulletin board. Ask the students the following questions:
1. What are natural resources? (Let the students develop a definition.)
 2. How do the natural resources available in a particular region affect the lives of people living in that region? (Accept all reasonable answers.)
- B. Explain that, in the Tennessee River Valley region, natural resources include water, soil, coal, copper, oil, and forests. Discuss each resource in terms of its location, form, and value. (Consult an economic atlas or an encyclopedia for more information.)

II. Activity

- A. Use the bulletin board map of the Tennessee River Valley produced in the previous activity ("Down In The Valley").
1. List the following natural resources on the board—coal, copper, oil, forests.
 2. Divide the students into four groups. Assign one of the above resources to each group, and have the members use construction paper to design and make a symbol for the resource. Have them make several copies of the symbol (more for forests).
 3. When the symbols are completed, have the students attach these symbols to the bulletin board map in the appropriate locations. Make a map legend. The finished map might resemble this:

| Legend | |
|--------|---------|
| ◆ | Coal |
| ○ | Copper |
| ♂ | Oil |
| ♣ | Forests |



- B. Discuss with the students why soil and water are so important to this region. Explain that they are going to investigate some of the problems we would have if we lost these resources.
1. Use an aluminum oven liner and the dough-clay mixture to make a "relief" map of the Tennessee River Valley.
 - a. Cook the dough-clay ingredients a short time (until they separate from the pan). Knead the dough and store it in a tightly closed container.
 - b. Use the grease pencil to draw the outlines of the states on the aluminum.
 - c. Instruct the students how to build the map. Highland regions can be built up with the dough-clay mixture and then covered with sand or soil; lowland areas will need only a thin layer of clay and a covering of sand or soil. Carve out ditches on the map to represent rivers.
 2. When the relief map is completed, have the students examine the topography of the region. Ask the students which area(s) will receive the most moisture after rainfall. Use a sprinkling can to pour small amounts of water on the map, and watch the water flow and erosion take place.
 3. Discuss with the students the positive and negative aspects of water movement in the area (e.g., water flow, overflow, erosion). Ask the students in which areas crops would grow better. Why? Why is the soil better in some areas?
- C. Define renewable resources. Ask the students which of the following resources are renewable. Water? (yes) Forests? (yes) Coal? (no) Oil? (no) Copper? (no) Soil? (No; although it can be replaced, the process is extremely slow.) What things could we do to replace the renewable resources? How can we conserve our resources?
1. Divide the students into groups. Assign a group to research current practices of using and conserving each of these resources—soil, water, and forest resources.
 2. Tell the students they are to develop plans to ensure the conservation or replacement of the resources to which their groups are assigned. Have them write a law designed to preserve the natural resource, including all the stipulations and penalties of the law.
 3. Have each group make a poster and make a one-minute presentation to convince others that its law should be passed. (Have the presentations video taped, if possible.)
 4. After all the presentations have been made, ask the class to discuss and vote on each law.

III. Follow-up

Use the following questions for discussion:

- A. What important natural resources are found in our region, and where are they located? (forests, coal, oil, copper, water, soil)
- B. Why are soils and rivers two of the most important natural resources in our region? (Soils are essential to farming; rivers are essential for water supplies and hydroelectric power generation.)

- C. Describe the effects of water flow on the soils of the Tennessee River Valley.
- D. Why should we be concerned about how these resources are used? (Accept all reasonable answers.)

IV. Extension

Have the students research the environmental effects of mineral mining and processing in the Copper Basin Area. Help them locate sources of information.

RESOURCES

Hodge, C.L. The Tennessee Valley Authority: A National Experiment in Regionalism. New York: Russell & Russell, 1968.

McCarthy, D.M., and C. W. Voigtlander, eds. The First Fifty Years: Changed Land, Changed Lives. Knoxville, TN: Tennessee Valley Authority, 1983.

Tennessee Valley Authority. Navigation on the Tennessee River. Video tape. (Time 13:19) On loan from TVA-University Network Environmental Education Centers.

A TIME FOR CHANGE

OBJECTIVES

The student will do the following:

1. Construct a model of a house appropriate for a given period of history.
2. Match energy-using devices and activities to their appropriate eras.

SUBJECTS:

Social Studies, Art,
Language Arts

TIME:

40-300 minutes

MATERIALS:

books with settings in earlier times, materials for building a model house from another era (boxes, popsicle sticks, glue, crayons, construction paper, magazine pictures, cardboard or posterboard), student sheet (included)

BACKGROUND INFORMATION

Many changes have taken place throughout the history of our country. People have been moving and searching for a better life. In the early years, life was very difficult. We were mainly an agricultural nation—self-supporting, growing our own food, building our own houses, and making our own clothing.

Today, we live in a nation that is much more diverse. We depend upon others for many necessities of everyday life. We have become more specialized in our occupations. Life has become easier as labor-saving inventions have been invented and improved. Lifestyles have changed drastically in the last 200 years. Many of these changes are related to changes in energy production and use.

PROCEDURE

- I. Setting the stage
 - A. Show the students some books that were well-known to children. Select books that depict different time periods and lifestyles. Obtain one book set in the early to mid-1800s (Laura Ingalls Wilder's books or Caddie Woodlawn, for example) and another set in the early 1900s (for example, Souder, Stone Fox, or Where the Red Fern Grows).
 1. Discuss the books and ask the students to describe what they think life was like in those time periods. Ask them about school, transportation, home, play, work, and so on.
 2. As the students summarize lifestyles in the early 1800s and 1900s, record that information on the board.
 - B. Add to the board the heading, "The Present." Ask the students to describe lifestyles in the present. Write their summaries on the board. Be sure to include the same kinds of information as are recorded for the earlier time periods.

II. Activity

- A. Divide the class into groups. Assign to each group one of these eras—early 1800s, early 1900s, and today.
1. Ask the students to brainstorm about life in the time periods assigned to their respective groups. Have them consider what houses looked like; what was used as a source of energy (coal, oil, wood, electricity, gas); what means of transportation were used (horses, cars, trains, motorcycles, bikes, walking); and what was done for recreation (reading, playing, writing, swimming, watching TV, listening to radio, using a VCR).
 2. One student in each group should record the lists generated by the brainstorming.
- B. After the students have examined their time periods in more depth, tell them they are going to make model homes representative of their time periods. (Suggestion: Students may work on this project outside of class time.)
1. Have each group decide how it is going to carry out this task. (The degrees of complexity of the models will depend upon the age and interest of the students.)
 2. Give the students some guidelines.
 - a. Each group must model a house and its furnishings as appropriate for its era. (Some groups may want to include the houses' surroundings or models of schools or other buildings, or an entire community.)
 - b. The students may use any media. Drawings or collages may be used. Lincoln logs, popsicle sticks, shoe boxes, posterboard, cardboard, or any other suitable materials may be used to build the house model. Furnishings may be drawn; pictures may be cut from magazines for use; or toys (e.g., dollhouse furniture) may be used.
 - c. Each group should be prepared to tell what energy resources were used, what methods of transportation were used, and how and what kinds of chores were done.
 3. When the projects are complete, have each group present its project to the rest of the class. (Suggestion: Have the students present their projects at a parent-teacher meeting.)
- C. Give each of the students a copy of the student sheet "A TIME FOR CHANGE," included.
1. Explain to the students that the four categories listed in Column A are to be answered with words from Column B. It may help them to number the items in Column B (using "1" for the 1800s, "2" for the early 1900s, and "3" for the present) before writing them in the appropriate blanks.
 2. When all the students have finished, check the worksheets together. Answers are as follows:

| | <u>1800s</u> | <u>1900s</u> | <u>Present</u> |
|-----------------|--------------|----------------|------------------|
| Transportation: | horses | autos | jet airplanes |
| Cooking: | over fire | stove | microwave |
| Laundry: | wash tub | wringer washer | automatic washer |
| Entertainment: | quilting bee | radio | VCR |

You may want to ask the students about other items or activities that could also fit into the eras.

III. Follow-up

Use the following questions as the discussion.

- A. How have the means of transportation changed over the years? (A suggested progression is horses to trains to autos to airplanes.)
- B. Name an energy form that we take for granted every day that did not exist in homes in the early 1800s. (electricity)
- C. If you had lived in the early to mid-1900s, what would you have done for entertainment? (You might have listened to the radio.)
- D. If you could choose any of the three time periods in which to live, which would you choose? Why? (Answers will vary.)

A TIME FOR CHANGE**COLUMN A****COLUMN B**Transportation

1800s _____

1900s _____

present _____

Cooking

1800s _____

1900s _____

present _____

Cleaning Clothes

1800s _____

1900s _____

present _____

Entertainment

1800s _____

1900s _____

present _____

stove

automatic washer

quilting bee

auto

jet airplane

microwave

wash tub

radio

over fire

horse

wringer washer

VCR

THE GOOD OLD DAYS?

OBJECTIVES

The student will do the following:

1. Distinguish between lifestyles before and after the creation of TVA (1933).
2. Based on current lifestyles, predict what life might be like in the future.

SUBJECT:

Social Studies

TIME:

60-120 minutes

MATERIALS:

student sheet (included)

BACKGROUND INFORMATION

When the Tennessee Valley Authority (TVA) was created by an act of Congress in 1933, the Valley region was in greater need of aid in natural resource management and economic development than other regions of the Nation. Per capita income and literacy levels were low, birthrates and disease incidences were high, and levels of soil depletion, erosion, and deforestation were high. About three-fourths of the Valley's population was rural, and only three of every 100 farms had electricity. The rural electrification, reforestation, flood control, and agriculture programs that TVA immediately established had dramatic results.

Today, the Valley's economy is healthier, its resources are managed better, and its people enjoy lifestyles that are generally much improved. As much progress as the region has made, however, there is still much to be done. Change is a constant, and the Valley must be ready for what the future holds.

PROCEDURE

I. Setting the stage

- A. Tell the students to close their eyes and imagine they are going back in time by means of a time machine. Tell them to picture what life was like about 100 years ago. Have them use knowledge they have gained from reading books and watching television as a basis for their imagining what life was like during this time.
- B. Ask the students to describe what they think life was like in their own community about a hundred years ago. (Include what they think homes, entertainment, transportation, work, and energy sources were like.) List their responses on the board.

II. Activity

- A. Give each student a copy of the student sheet "WHAT WAS IT LIKE WHEN YOU WERE YOUNG?" (included), and have each ask the oldest person he/she knows (parent, grandparent, great-grandparent, neighbor, member of church, etc.) to complete the survey.
 1. When the surveys are completed, draw a time line on the board, putting the earliest year reported at one end and the most recent year at the other.

2. Fill in the time line with the information reported by the students.
 3. When all the information is recorded, compare the responses across the years. Is there any point at which dramatic changes occur?
 4. OPTIONAL: Students can survey two or three people of varying ages and develop their own time lines from which they can make comparisons.
- B. Add to the time line the dates on the teacher sheet "IMPORTANT EVENTS," included. Explain to the students that you will add to the time line the important events given on the sheet.
1. At 1796, label "Tennessee became a state" (or label the year your state achieved statehood).
 2. Continue with the other dates and events on the time line. Discuss the items with the students as you record them, comparing the events with the lifestyles previously recorded.
 3. Add the present year to the time line (at the end of the board).
 - a. List the students' responses to the questions on the survey.
 - b. Compare their responses with the first entries.
 4. Ask the students to speculate what life might be like in the future, based on the changes that have already taken place. Consider food preparation; clothing care, transportation, work, and entertainment.

III. Follow-up

Ask the students the following questions:

- A. When was TVA created? (1933)
- B. What were the main energy sources around the turn of the century (1900)? (wood and coal) What is the main energy source used today? (electricity)
- C. What kind of work did most people do more than 50 years ago? (agriculture) What do most do today? (business and industry)
- D. Choose one of these categories—food preparation, clothing care, transportation, entertainment, work—and describe what they might be like 50 years from now.

IV. Extension

Have the students create a mural depicting the changes noted on the time line.

RESOURCE

McCarthy, D.M. and C. W. Voigtlander, eds. The First Fifty Years: Changed Land, Changed Lives. Knoxville, TN: Tennessee Valley Authority, 1983.

WHAT WAS IT LIKE WHEN YOU WERE YOUNG?

What is the earliest year you can remember as a child? _____



How was your home heated? _____



How was your food cooked? _____



How were your clothes washed and dried? _____



What chores did you have to do at home? _____



What kind of transportation did you have? _____



Did you have electricity in your home? _____

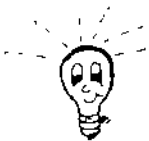

Which of these items did you have in your home?

- | | |
|--|--|
| <input type="checkbox"/> Electric refrigerator | <input type="checkbox"/> Record player |
| <input type="checkbox"/> Freezer | <input type="checkbox"/> Television |
| <input type="checkbox"/> Dishwasher | <input type="checkbox"/> Tape Player |
| <input type="checkbox"/> Radio | <input type="checkbox"/> VCR |

IMPORTANT EVENTS

| | 1796 | 1850 | 1900 | 1933 | (Present) |
|--|----------------------------|--|--|--|---|
| | Tennessee becomes a state. | <ol style="list-style-type: none"> 1. Mining prospers in the Copper Basin. 2. Forests are cut down because much wood is needed, and erosion becomes a problem. | <ol style="list-style-type: none"> 1. Most people live in rural areas. 2. Life is difficult and money is scarce. 3. Few farms have electricity or running water. 4. Problems with soil erosion continue. 5. There are few industries. 6. Wood and coal are major energy sources. 7. The educational system is poor. | <ol style="list-style-type: none"> 1. TVA is created. 2. Construction begins on dams to help with flood control, navigation, and hydroelectric generation. | <ol style="list-style-type: none"> 1. Urban areas are doubled. 2. The population growth rate is 16.5%. 3. Gains are being made in education. 4. Incomes are increased. 5. Workers have moved from agricultural to industrial jobs. |

POLLUTION, POLLUTION EVERYWHERE

OBJECTIVES

The student will do the following:

1. Identify three types of pollution (land, water, and air).
2. Classify human activities as to whether they pollute or protect the environment.
3. Evaluate ways to stop pollution.

SUBJECTS:

Science, Art, Social Studies, Health

TIME:

100-140 minutes, plus an on-going activity

MATERIALS:

glass of water, salt, bag of trash, aerosol product, clothes hanger, string, (2) 1-quart milk cartons, buttons, returnable/recyclable and throw-away soft drink containers, flashlight or slide projector, 2 pieces of white paper, petroleum jelly, magnifying glass, student sheets (included)

BACKGROUND INFORMATION

All of us are part of the environment. Everything we do affects our environment; individually and collectively, our activities ultimately benefit or harm our world. Many human activities release substances or materials into the environment that are harmful to us, to other living things, and/or to the environment itself. These pollutants may contaminate land, water, or air resources.

Land pollution can be thought of as mainly the waste which we produce and dispose of in such large quantities. Some is carelessly thrown away as litter; some is dumped indiscriminately; and most is buried in community landfills. The construction and management of a sanitary landfill is intended to protect the environment from the effects of the waste buried there (e.g., to prevent water pollution from substances in the buried waste). Landfills, however, are filling up quickly due to the amount of waste we produce (an average of over four pounds per day per typical American). Land suitable and available for landfills is scarce.

Water pollution can result from a variety of human activities. Many industries and communities dispose of their wastewater in streams. Mining, farming, and construction activities can pollute streams with chemicals and/or eroded soil. Any time water is used or runs over a land area (e.g., when some rainwater runs off over a field or a city's streets rather than soaking into the ground), it may pick up pollutants. Many of these pollutants stay in the water—whether the water is used again, flows back to the ocean, or seeps down into the earth to be stored as groundwater.

Air pollution is most often the result of the burning of some kind of fuel or the release into the atmosphere of some kind of industrial substance. Burning any kind of fuel—even wood—results in undesirable by-products. Many of them can be prevented by very efficient burning. Some can be partly prevented from being released by the use of pollution control devices. Others are unavoidable; for example, carbon dioxide is always a major byproduct of burning any kind of fuel. (The "greenhouse effect"—the warming of the earth due to excessive solar heat trapped by our atmosphere—is due to an atmospheric build-up of carbon dioxide from our heavy use of fuels.)

Terms

environment: all the things—natural and manmade, living and nonliving—that surround us.

groundwater: water stored in the soil or rocks underground.

landfill: a large outdoor area for waste disposal.

pollutant: matter that makes something impure or contaminated.

pollute: to make something impure or to contaminate.

recycle: to separate a given waste material from other wastes and process it so that it can be used again in a form similar to its original use; for example, newspapers can be processed into cardboard.

reuse: to use something again for its original purpose; for example, returnable milk bottles are reused.

surface water: water that flows over the land in lakes, rivers, and streams.

water cycle: the natural cycle in which water evaporates from the surface of the earth, rises through the atmosphere, condenses, and returns to earth as precipitation.

PROCEDURE

I. Setting the stage

- A. Have the students list things they do to stay healthy. Discuss the fact that the community also has to do things to keep the environment healthy. We call this field public health. Ask what the students think a community does to keep healthy.
- B. Write the word "pollute" on the board, and tell the students that the word "pollute" means to make something impure. Explain that you are going to represent three major types of pollution.
 1. Take a bag of trash and throw it around the room. Ask what represented part of the environment is being polluted. (Lead the students to answer "land.")
 2. Take a glass of water and pour salt into it. Ask what represented part of the environment is being polluted. (After the students guess "water," ask them if they would drink the glass of water. Why, or why not?)
 3. Spray an aerosol product around the room. Ask what represented part of the environment is being polluted. (air)

II. Activity

A. Ask the students what they or their parents do with a cotton shirt that someone has outgrown. Responses might include that they give it to someone (reuse it), tear or cut it up for use as rags (recycle it), or throw it away (in which case it ends up in a landfill). Lead the students to think about where the things they throw away wind up. What happens when the community's landfill is full and cannot hold any more trash? When the landfill is full, a new one has to be prepared. Landfills require a special kind of land. When that kind of land is used up, we have a big problem about where to put our trash.

1. Point out to the students that much of the waste we all throw away daily could be reused or recycled. Discuss with the students the meanings of the terms landfill, reuse, and recycle.

2. Make a balance scale by using a clothes hanger, string, and two milk cartons, using the illustration here as a guide. Put a happy face and the word "save" on one carton; put a sad face and the word "waste" on the other.

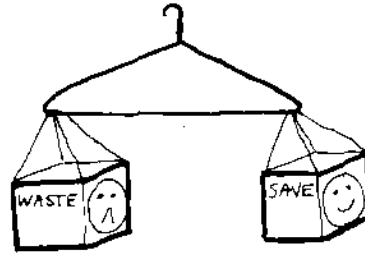

a. Discuss ways in which we waste or save paper at home, at school, and when we eat out. Wasted paper means wasted trees (because wood pulp is used to make paper). Tell the students that each time they waste paper, they are to put a button in the "waste" box; when they save paper, they are to put a button in the "save" box. If they prepare paper for recycling, they may put two buttons in the "save" box.

b. Discuss with the students the use of returnable or recyclable bottles and cans versus throw-away bottles and cans. Display several samples so pupils can learn to distinguish between them. Tell the students that when they choose soft drinks in returnable or recyclable bottles or cans, they are to add one button to the "save" box; each time they choose throw-away containers, they are to add a button to the "waste" box.

c. If they pick up some litter and dispose of it properly, they may add two buttons to the "save" box. Suggestion: Have the students report exactly what they did before they deposit buttons.

B. Give each student a copy of the student sheet "WATER COMES AND GOES, AND COMES AND GOES" (included), and discuss it with them. (Suggestion: For younger students, the student sheet could be presented section by section, concept by concept.)

1. Review the water cycle with the students.

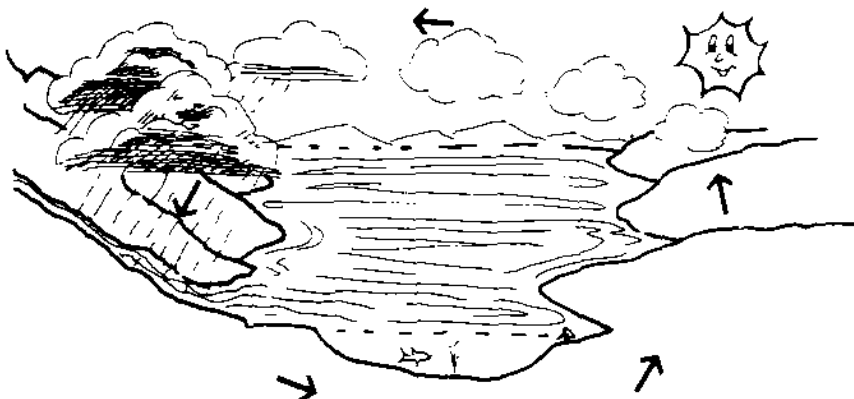

2. Tell the students that available water is used over and over again. Polluted water from one area goes to another area, where it is used again. Each time water is used, it may be polluted again (with the same or different pollutant[s]). Students may need familiar examples in order to understand the concept.
 3. Point out that there are many ways water may be polluted and that we rely on both surface water and groundwater. Nearly half of the Valley's residents, and 98 percent of the rural population, relies on groundwater for its water supply. Pollution of groundwater is a serious problem, especially near cities and industrial sites. Surface water pollution is also a serious problem. Cities and factories discharge wastes directly into streams, and water runs off from farmlands, mining areas, and cities into streams.
 4. Together with the students, discuss and list ways in which we waste water and ways in which we pollute water. Have the students add buttons to the "waste" box when they waste or pollute water; have them add buttons to the "save" box when they save or avoid polluting water.
 5. When buttons are added to the "save" box, ask the students to share with the class how they avoided wasting or polluting water.
- C. In a darkened room, turn on a flashlight or slide projector. Observe the specks of dust floating in the light. Explain that these specks are particulates—a big word for tiny things! From where do particulates come?
1. Explain to the students that pollutants can be released into the air. Because industries and transportation are the primary sources of pollutants, the Valley's large cities typically suffer the poorest air quality in the region, but rural areas have problems too. One kind of air pollution is particulates.
 2. Give the students the student sheet "PARTICULATES" (included), and discuss it with them. Answer to puzzle:

| | | | | | | | | | | | | | |
|---|---|---|---|---|---|---|---|---|---|---|---|---|---|
| Q | P | Y | E | V | R | K | O | I | M | N | G | I | A |
| U | R | A | O | M | S | A | N | K | J | P | E | N | T |
| M | I | Z | R | U | Y | I | W | E | Q | B | C | K | E |
| A | B | U | S | T | U | R | A | M | U | T | F | D | G |
| O | B | M | L | Q | T | O | R | H | T | I | H | U | O |
| N | J | O | O | V | F | C | P | S | C | Y | O | T | N |
| E | S | H | S | D | X | N | U | G | E | Z | J | O | F |
| S | C | A | M | L | E | A | P | L | S | I | J | O | T |
| M | B | M | O | I | H | D | S | Y | A | R | P | S | O |
| T | I | L | K | K | U | Q | N | E | H | T | Z | P | Y |
| J | J | O | E | F | H | Y | K | R | W | P | E | V | A |

3. Smear petroleum jelly on two clean pieces of white paper. Hang one sheet outdoors in a place protected from the rain. Hang the second piece indoors away from open windows. Together with the students, compare the two sheets at the end of one day, after one week, and again in two weeks. Compare the sheets with a clean white sheet of paper. Use a magnifying glass to look at the particulates. Ask the students how dirty the air outside is compared with the air inside. From where do they think the particulates came?
4. Discuss ways in which we pollute the air (e.g., open burning) and ways in which we keep the air healthy (e.g., automobile exhaust filters, smoke stack scrubbers, not using chlorofluorocarbon aerosols, burning unleaded gasoline). Have the students add buttons to the appropriate box when they acknowledge given behaviors.

- D. After a few days, note the balance of the scales. How did the activities affect the outcome? If the students affected the environment in a positive way, have them each design a badge to show how he/she helped. Let them wear their badges.

III. Follow-up

- A. Ask the students the following questions:

1. What three parts of the environment do we pollute? (air, water, land)
2. How do we use water, air, and land? How do we pollute water, air, and land?
3. What are some ways we can stop pollution? (Some answers are to recycle trash, put waste in its place, walk instead of drive, and have laws that regulate what industry can or cannot do.) Which are the most important? Why? Which will you practice?

- B. Give the students the student sheet "I SPY POLLUTION," included. Answers are as follows:

1. Air pollution is shown in (a); land pollution is shown in (b); and water pollution is shown in (d).
2. Answers to the essay question will vary.

IV. Extension

- A. Have the students research other types of air pollution (e.g., ozone, sulfur dioxide, nitrogen dioxide, carbon monoxide, and lead). The visual sheet "EFFECTS OF AIR POLLUTION" (included) can be used to support this activity. (The students may investigate water and land pollution in more depth also.)

- B. Have the students collect articles or reports about environmental issues (water, air, or waste disposal) over a period of several weeks. Places to look for information include newspapers and the public library. Some students may write to their state's Department of Natural Resources and the Environmental Protection Agency office in their area. Have the students organize their information into a table similar to the one below.

| Headline Date, Name of Source | Brief Description of Event | Causes | Effects | Personal Comments |
|----------------------------------|-------------------------------|--------|---------|----------------------|
|----------------------------------|-------------------------------|--------|---------|----------------------|

RESOURCES

Division of Air Pollution Control, Natural Resources and Environmental Protection Cabinet (Commonwealth of Kentucky). "Air Pollution Teaching Aids." Frankfort, KY: Author, 1987. (Address: Division of Air Pollution Control, Fort Boone Plaza, 18 Reilly Road, Frankfort, KY 40601.)

McCarthy, D.M. and C. W. Voigtlander, eds. The First Fifty Years: Changed Land. Changed Lives. Knoxville, TN: Tennessee Valley Authority, 1983.

Tennessee Valley Authority. "Answers to the Most Frequently Asked Questions About TVA". N.p.: Author, n.d. (This publication is not available for distribution.)

Toast (film). Bullfrog Films, Inc. (Address: Oley, PA 19547, or call 1-800-543-FROG.) 12 minutes, 16mm color/sound. Study guide. Grades 3 - Adult. May be purchased or rented; video also available for purchase.

WATER COMES AND GOES, AND COMES AND GOES

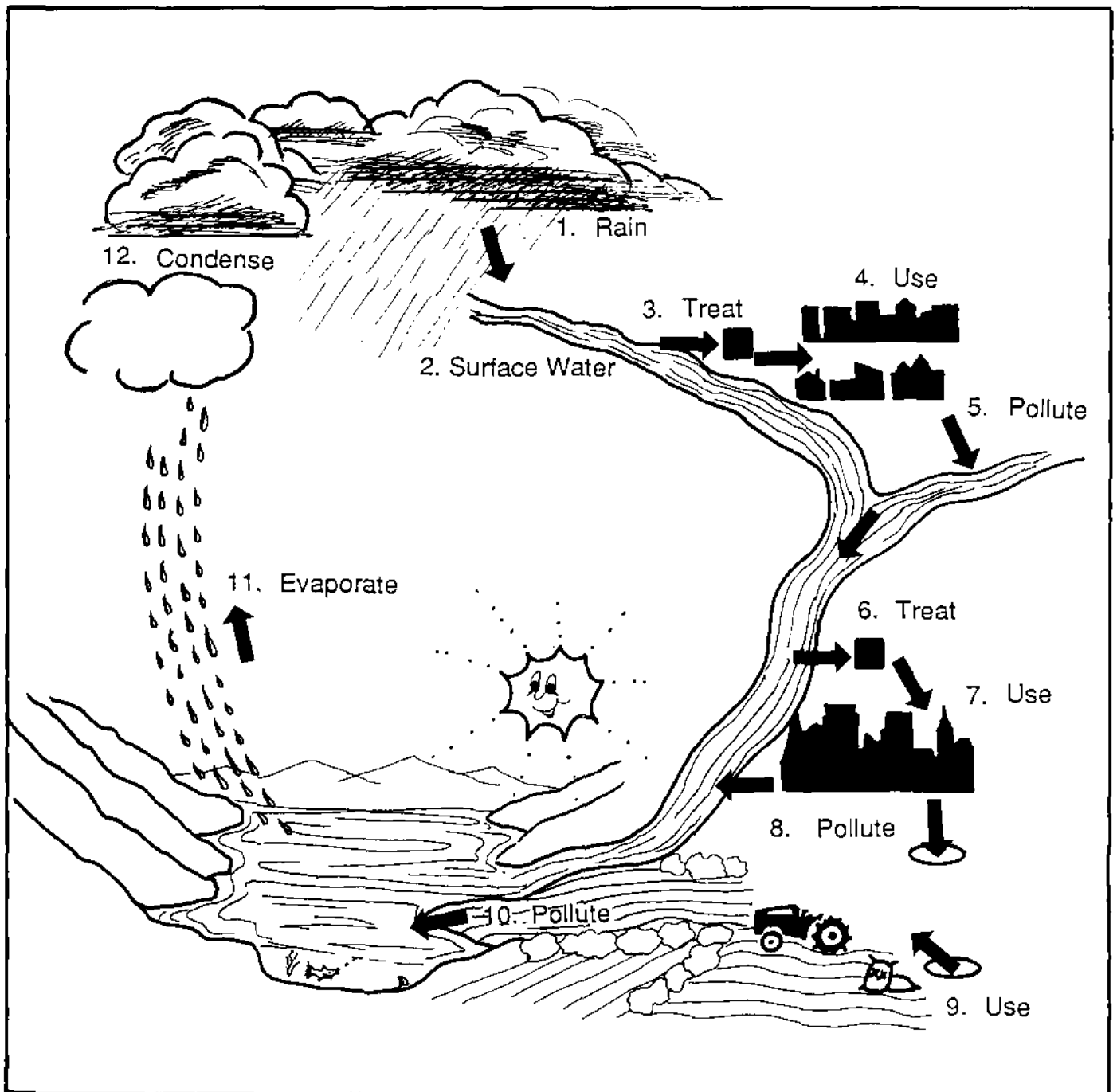

PARTICULATES

(par tik yoo lits)

What is a particulate? A particulate is a small piece of dust or other matter in the air, such as smoke or something from a spray can. Look at a beam of light shining in a dark room. Look at the dust on the table or TV. Where else do you see particulates?

Where do particulates come from? They come from burning leaves or wood, car exhaust, industries, and other places. Look at "clouds" of dust on a gravel road or behind a tractor plowing a field, or smoke and soot coming from the smoke stacks on industries. Where else do you think particulates come from?

How does particulate pollution affect us? It can cause breathing problems, eye irritation, and building and clothing damage. Look at statues and buildings in the city. Look at buildings near a factory. Where else can you find problems?

PARTICULATE. . . a big word for small matter.

Find and circle in the puzzle the words listed below. They may be up-and-down, from side-to-side, or from corner-to-corner. They may also be written forward or backward.

PARTICULATE
DUST
SMOKE
SPRAY
SOOT
EXHAUST

| | | | | | | | | | | | | | |
|---|---|---|---|---|---|---|---|---|---|---|---|---|---|
| Q | P | Y | E | V | R | K | O | I | M | N | G | I | A |
| U | R | A | O | M | S | A | N | K | J | P | E | N | T |
| M | I | Z | R | U | Y | I | W | E | Q | B | C | K | E |
| A | D | U | S | T | U | R | A | M | U | T | F | D | G |
| O | B | M | L | Q | I | O | R | H | T | I | H | U | O |
| N | J | O | O | V | F | C | P | S | C | Y | O | T | N |
| E | S | H | S | D | X | N | U | G | E | Z | J | O | F |
| S | C | A | M | L | E | A | P | L | S | I | U | O | T |
| M | B | M | O | I | H | D | S | Y | A | R | P | S | O |
| T | I | L | K | X | U | Q | N | E | H | T | Z | P | Y |
| U | J | O | E | F | H | Y | K | R | W | P | E | V | A |



I SPY POLLUTION

1. Look at the pictures. Circle each picture in which you see evidence of pollution.

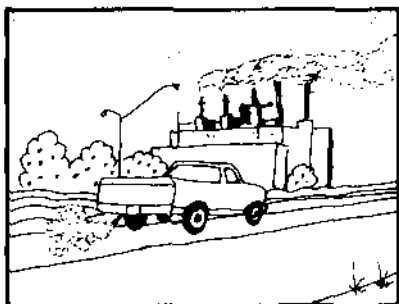

a.



b.

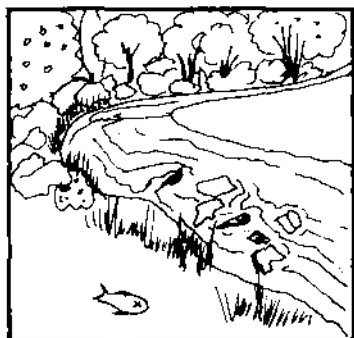

d.

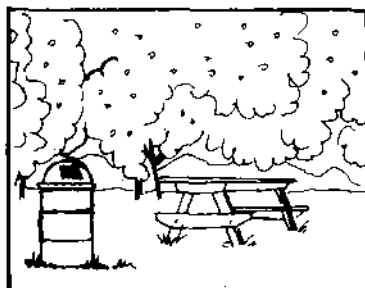



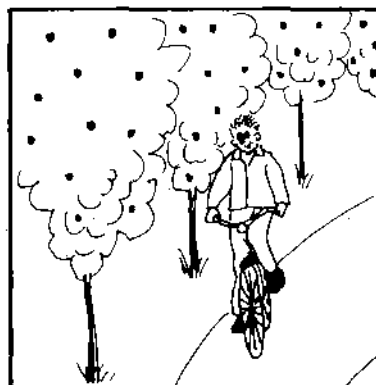

c.



e.

2. Choose one of the circled pictures. On the lines below, write four or five sentences about the type of pollution shown in the picture, its harmful effects, and ways to prevent it.

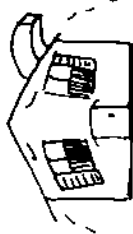
EFFECTS OF AIR POLLUTION

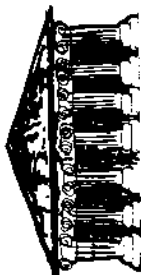
| | Particulates | Sulfur Oxides | Nitrogen Oxides | Ozone | Carbon Monoxide | Lead |
|--|--------------|---------------|-----------------|-------|-----------------|------|
| PEOPLE AND PETS  | X | X | X | X | X | X |
| PLANTS  | X | X | X | X | | |
| BUILDINGS AND MATERIALS  | X | X | X | X | | |
| WILDLIFE AND LIVESTOCK  | X | X | X | X | | |
| CLEAN APPEARANCE  | X | | | | | |

LOOKING AHEAD

OBJECTIVES

The student will do the following:

1. Describe the ways in which people have adapted to and modified their environments in providing their needs.
2. Predict ways in which new ideas will effect change in the lives of people.
3. Plan a community of the future.

SUBJECTS:

Social Studies, Art

TIME:

75-120 minutes

MATERIALS:

picture postcards, posters, or magazine pictures of various geographical locations; atlas; various materials that students decide to use in designing their communities; student sheets (included)

BACKGROUND INFORMATION

Which resources should be developed? Which will be sacrificed? preserved? What purposes will they serve? How much planning will be done and by whom? These are some of the questions facing us in the Tennessee River Valley. Effective resource management is the key to the Valley's future. We must continue our efforts to solve existing problems and conflicts over the use of resources in order to protect the environment from harm.

A central question facing the region is whether or not continued improvement in environmental quality is compatible with the vigorous and expanding economy needed to sustain an acceptable standard of living and quality of life. Experience indicates that the environment can be safeguarded and improved without disrupting the economy. Indeed, environmental quality may be thought of as a necessary ingredient for a healthy economy.

Terms

basic needs: anything people must have in order to live (shelter, clothing, food, and water).

community: a group of people living in the same place.

environment: all of the things—natural and manmade, living and nonliving—that surround us.

population: the number of people in a given area.

resource: a supply of a valuable or useful thing; something that can be used to make or supply something else.

PROCEDURE

I. Setting the stage

- A. Have several students give a one-minute spontaneous reaction to the following questions:
 - 1. Who plans for the future?
 - 2. Why worry about tomorrow?
- B. Have the students draw a cartoon depicting the frustration felt by a person who finds himself "in trouble" because he didn't plan ahead. (Option: Have the students discuss these situations.)
- C. Define the term "basic needs." Ask the students to list some basic needs, and write the responses on the board.
 - 1. Ask the students why each need is important.
 - 2. Ask the students to list other things that are important in their lives.
 - 3. Have the students suggest ways their basic needs are met. How are the items on their list of important things provided?
 - 4. How can we improve the chances that our basic needs will continue to be met in the future?

II. Activity

- A. Explain to the students that they are the citizens of the future. The way in which people take care of the environment today determines how they will live in the future.
 - 1. Have the students list things in the environment that they will need in the future.
 - 2. Ask them to list some things that will harm the environment.
 - 3. Discuss with the students how we can protect the environment.
- B. Have the students bring in postcards, posters, or magazine pictures illustrating a place they have visited or someone else has visited. Discuss the environmental differences that exist in different geographical locations; some things to consider are rivers, oceans, mountains, population, and pollution.
 - 1. Discuss with the students how each environment compares with the students' own environment.
 - 2. Discuss with the students the impact of people on the environments of these places. How do the environments affect the people living in them (e.g., health and practices)?
 - 3. Ask the students which of the environments they have talked about seems to be the best place to live? Why?
 - 4. Have each student design a postcard or picture showing the type of environment in which he or she would like to live.

- C. Share with the students the following information: The population of the Valley is expected to increase by 25 percent between 1980 and 2000. Many people are expected to move into the Sunbelt as they are attracted to manufacturing and service jobs.

Between 1930 and 1980, most of the growth that occurred was in the middle and eastern parts of the region and was concentrated around four major cities: Asheville, North Carolina, and Nashville, Chattanooga, and Knoxville, Tennessee. Locate these cities on a map. (Suggestion: Discuss cities close to your community.)

1. Ask the following questions.
 - a. Why do people move to an area? (Have any of the students moved from one place to another? If so, how was the new place different?)
 - b. When there is a large population in one area, how does it affect the environment?
 - c. When an area's population increases, what changes have to be made in the area?
2. Divide the class into groups. Ask each group to plan a community of the future, using the student sheet "PLANNING A COMMUNITY" (included) as a guide.

III. Follow-up

Use the following questions for discussion.

- A. Why is it important to plan for the future? (We must be able to preserve the things that help us meet our basic needs.)
- B. How do people affect an environment? (They use up its resources; they can either use or abuse the environment, depending upon their values and needs.)
- C. Select one item from the list of environmental resources needed for our use. What new ideas will affect that resource? How?
- D. Considering the groups' planned communities, what might a model community be like in the future? (Encourage the students to share ideas that are really different.)

IV. Extension

Have the students research population growth, using the student sheet "GO WITH THE FLOW," included. Where are these cities located in the Valley region?

RESOURCES

McCarthy, D.M. and C. W. Voigtlander, eds. The First Fifty Years: Changed Land, Changed Lives. Knoxville, TN: Tennessee Valley Authority, 1983.

Tennessee Valley Authority. "Answers to the Most Frequently Asked Questions About TVA." (pamphlet) N.p: Author, n.d. (This publication is not available for distribution.)

Why Man Creates (film). Media, PA: Pyramid Films, n.d. (Address: Box 496, Media, PA 19063. Available for rent or purchase.) Note: Show only the first segment of the film.

PLANNING A COMMUNITY

1. Where will your community be built? _____
 Will it be near water? _____
 Where will it get its drinking water? _____
 Will it be in a flat place? _____
 Will it be built on hills? _____
 Will it be on a large highway, or on a smaller road? _____
 Will it be near a railroad? _____
 Will it have an airport? _____
 Will it have a bus station? _____

2. Will the homes be houses or apartment buildings? _____
 Will the community need schools? _____
 What places for recreation will it have? _____
 Will it have churches? _____
 Where will people get their food and clothing? _____
 Where will they buy other things they need? _____

3. How will the people get news? _____
 How will they govern themselves? _____

4. What else will they need? _____

MODELING A COMMUNITY

1. Draw a large map of how your community will look.
2. Build a model of your planned community, using small objects to "build" everything on your map. Make sure you leave room for streets.
3. Tell why you made your community as you did.

GO WITH THE FLOW

1. Use an atlas and find the population of each of these cities in the Tennessee Valley region.

| City and State | Population | Rank |
|---------------------------|------------|------|
| Asheville, North Carolina | | |
| Canton, North Carolina | | |
| Chattanooga, Tennessee | | |
| Columbus, Mississippi | | |
| Decatur, Alabama | | |
| Huntsville, Alabama | | |
| Knoxville, Tennessee | | |
| Muscle Shoals, Alabama | | |
| Nashville, Tennessee | | |
| Paducah, Kentucky | | |
| Saltville, Virginia | | |
| Tupelo, Mississippi | | |

2. Rank the cities from 1 (highest) to 12 (lowest) in population.
3. Research the three most populated cities to determine the reasons why people moved there.
4. Compare the three most populated cities with the three least populated cities. What are some reasons why people have not moved there?

GLOSSARY

basic needs: anything people must have in order to live (shelter, clothing, food, and water).

community: a group of people living in the same place.

drainage basin: the land area that contributes water to a stream.

environment: all of the things—natural and manmade, living and nonliving—that surround us.

groundwater: water stored in the soil or rocks underground.

landfill: a large outdoor area for waste disposal.

landform: a naturally formed feature of the terrain, such as a mountain, valley, or plateau.

legend: a chart explaining the symbols or illustrations used on a map.

natural resource: something from nature that people need or want, such as water, coal, soil, forests, and beauty.

nonrenewable: not able to be restored or replenished.

plateau: an elevated expanse of relatively level land.

pollutant: matter that makes something impure or contaminated.

pollute: to make something impure or to contaminate.

population: the number of people in a given area.

recycle: to separate a given waste material from other wastes and process it so that it can be used again in a form similar to its original use; for example, newspapers can be processed into cardboard.

reforestation: the planting of trees to replace trees that have been destroyed or harvested.

renewable: able to be restored, replaced, or replenished.

resource: a supply of a valuable or useful thing; something that can be used to make or supply something else.

reuse: to use something again for its original purpose; for example, returnable milk bottles are reused.

river valley: the extensive land area drained by a river system.

soil erosion: the loss of soil due to washing away (by water) or blowing away (by wind).

surface water: water that flows over the land in lakes, rivers, and streams.

tributary: a stream that flows into a larger stream.

water cycle: the natural cycle in which water evaporates from the surface of the earth, rises through the atmosphere, condenses, and returns to earth as precipitation.

ENERGY

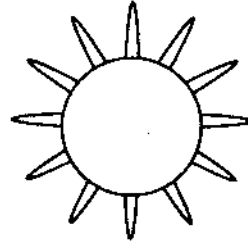

ENVIRONMENT

ELECTRICITY

RESOURCES

CHANGE

VALLEY

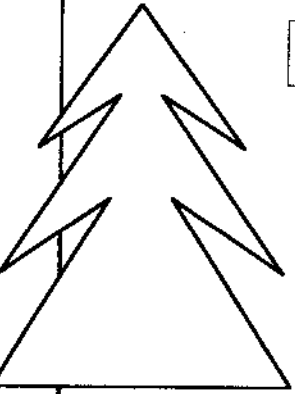
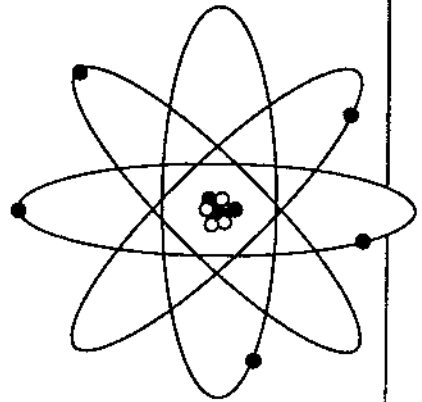

ENERGY

Energy Defined

Most of us have some intuitive idea of what "energy" means. Although we might not be able to formulate a definition of the word, we use it often and in various contexts. The definition of energy used most often in physical science is "the ability to do work." What does "work" mean? Work can perhaps most easily be defined as a change in the position, speed, state, or form of matter. Therefore, energy is the capacity for changing matter.

Perhaps it is easier to think in terms of what energy does than what it is. How do we detect energy; that is, how is it displayed? When heat or light is given off, energy is displayed. When objects move, energy is displayed. When sound is produced, energy is displayed. There are many ways in which we detect that energy is changing matter.

Law of Conservation of Energy

Obviously, energy is a rather abstract concept. In fact, the importance of the concept of energy was not really understood by scientists until the mid-1800s. Up until that time, scientists dealt with all the different known kinds and manifestations of energy as separate entities. The idea of energy as a universal concept—one thing that can take many forms and change from form to form—was then conceived. With this realization came the development of the principle of energy conservation ("scientific" conservation—not "utility bill" conservation). The Law of Conservation of Energy states that the total amount of energy in a system (even the universe) remains constant ("is conserved") although energy can be changed from one form to another or transferred from one object to another. The concept of energy conservation is one of the fundamental concepts of modern science.

The energy conservation principle means that energy is conserved—still exists in some form—even though we may no longer be able to detect it or harness it for our purposes. For example, energy changes forms many times in the process of generating electricity in a fuel-burning power plant and then using the electricity to toast a piece of bread. Along the way, much energy escapes, primarily as waste heat. Just think of all the heat that escapes from the toaster alone. It is not put to use toasting the bread at all; in fact, it merely warms the air and the surface on which the toaster sits. Eventually the heat is so scattered that we can no longer detect it, but it still exists. The amount of energy in the universe is constant although the energy itself changes. This sequence of changes may be thought of as energy flow. Energy flows throughout the universe, constantly changing but remaining constant in total amount.

Forms of Energy

What are some of the forms in which energy can be found? Energy may be classified as either kinetic or potential energy. The easiest way to think of these is to generalize the terms. "Kinetic" refers to motion, so matter that is moving or displaying phenomena related to motion (such as heat, light, sound, and so on) has kinetic energy. Matter that has the capacity of doing this—but is not doing it—has potential energy. There are two ways in which matter may have potential energy. Some matter has stored energy by virtue of its composition. (Examples include fuels.) Some matter has energy by virtue of its position; think, for example, of an arrow held in a drawn bow.

Heat, light, sound, and motion are forms of energy familiar to us in our everyday lives. There are five energy forms from which we often obtain these, and these are also familiar to us. Mechanical energy is the energy found in machines. It in turn comes from whatever powers the machines, including electricity, flowing air (or water or steam), or human or animal muscle power. Of course each of these can be traced back through a chain of energy transformations also. Chemical energy is the energy contained in the chemical makeup of fuels or batteries. Again, it is but one form in a chain of energy transformations. In order to see the effects of chemical energy, we must do something to release it. Solar energy is the energy that comes to earth from the sun. It is primarily heat and light. The solar energy supplied throughout the earth's history is the source of almost all the energy on the earth. Nuclear energy is one of the only energy forms that cannot be traced back to the sun. Its source is the incredible energy binding together the particles making up the nuclei of atoms; when nuclei are split apart or fused together, energy is released. Electrical energy is found in nature in lightning, a form unusable to us. The electricity on which we are so dependent today is produced from other energy forms using machines we invented. We use it to produce many forms of energy.

Energy Use and Resources

When we speak of "energy," we are usually referring to energy resources and the ways we use them. Energy resources are the things we obtain from nature in order to use their energy. All fuels are obtained from nature; these include coal, oil, gas, wood, crops for alternative fuel production (such as alcohol from grain), and uranium for nuclear power. Energy from the sun is the earth's primary energy resource. The energy we get from wind and water depend on the sun. Heat from deep inside the earth (geothermal energy), the energy of rising and falling tides, and the energy available from ocean temperature differences (even that from seawater itself) are resources we may be able to use more in the future.

Our demand for energy and our consumption of energy resources has increased at a much greater rate than the growth of human population. This is due to the fact that we have invented ever-increasing numbers of devices that consume energy resources. These devices replace human and animal labor and make our lives much easier than those of our ancestors (or of people in less-developed areas of the world). We pay a price, however, in that we are so dependent upon the energy resources we consume.

MATTER AND ENERGY

Definitions

The two fundamental concepts in science are matter and energy. Everything can be classified as either matter or energy. Matter is anything that occupies space and has mass. Energy is the ability to do work, that is, to change matter.

Changing Motion

There are many ways in which energy can change matter. The most obvious way is by changing its position or moving it. In fact, for a moving object's motion to change, energy is required. This means energy is required to change a moving object's speed or direction of motion. It even takes energy to stop a moving object. Energy is required to keep an object from being pulled down by the force of gravity; for example, a person must apply energy to an object he/she is holding in order to keep it from dropping to the floor, and an aircraft must use fuel to remain airborne.

Physical Changes

Energy can cause physical changes in matter other than those associated with motion. Physical changes are those in which the object or material is changed in shape, temperature, state, or some other way and yet remains the same chemically (is still the same substance). For example, an ice cube can be heated to liquid water and even to steam; its state changes as heat energy is applied, but the water is the same chemically. A object can be crushed into tiny pieces (which requires energy), but each piece is still the same material (e.g., glass or plastic) as before.

Chemical Changes

Chemical changes in matter involve energy. These are changes in which substances themselves are changed; the atoms making up the substances are rearranged so that different substances result. This is but another way to say "chemical reaction." In a chemical reaction, one or more reactant substance(s) undergoes an energy-related change to yield one or more product substance(s). A very basic example is photosynthesis, the process by which green plants use the energy of sunlight to produce sugar (composed of carbon, hydrogen, and oxygen) and oxygen from water (hydrogen and oxygen) and carbon dioxide (carbon and oxygen). Another everyday example is burning a fuel. Burning is essentially combining oxygen (from air) with the carbon-rich substances making up fuels. Chief products are always carbon dioxide and water. (Burning releases energy, but a small amount of energy must be applied to start the process.) All chemical changes either take in energy or give off energy.

Nuclear Changes

Nuclear changes in matter are much less commonplace. They release tremendous amounts of energy, but they require that energy be applied to begin them. Nuclear changes occur when the atoms making up certain substances are themselves changed; nuclei (within atoms) are changed so that the matter is fundamentally different than it was. For example, the vast amount of energy emitted from the sun is the result of the fusion of hydrogen atoms (the simplest atom) to form helium atoms. Two hydrogen atoms are required to make one helium atom. This is possible only at incredibly high temperatures. The combination of nuclei releases huge amounts of energy, some of which reaches the earth. While some very simple, small nuclei can be fused to form others, some large, heavy nuclei can be split to form somewhat smaller ones. This is called fission. The fission of a special kind of uranium atom is what yields the energy we harness to generate electricity in nuclear power plants.

Mass-Energy Equivalency

Another key matter-energy concept is related to the nuclear changes discussed briefly above. Einstein's famous relativity equation, $E = mc^2$, expresses the relationship between matter and energy. In the equation, **E** is the total energy of the nuclear reaction, **m** is the mass of the particles involved in the reaction, and **c²** is the speed of light squared (multiplied by itself). This deceptively simple equation explains why very, very small changes in mass occur when nuclear changes occur and why such tremendous amounts of energy are released. For example, if one kilogram (1,000 grams or about 2.2 pounds) of uranium undergoes fission, the resulting products will have a mass of only about 999 grams. One gram (454 grams equal one pound) of mass will have disappeared (even though the number of particles will be the same as before). The gram of matter will have been converted to the equivalent of about 25 million kilowatt-hours of electricity, about one day's output of a modern power plant.

Apparently, matter and energy are somehow different forms of the same thing; they can be interchanged. Neither mass nor energy can be created or destroyed, but matter can be converted into energy. This is sometimes called mass-energy equivalence.

KINETIC AND POTENTIAL ENERGY

Classifying Energy

Energy—the ability to do work—can be classified as either kinetic or potential energy. Kinetic energy is most easily thought of as the energy possessed by a moving object. Potential energy can likewise be thought of as the energy an object has as the result of its position (as opposed to its motion).

Kinetic Energy

Objects that are moving obviously have kinetic energy. A ball that has been thrown, a yo-yo going up and down on its string, a vehicle traveling on the road, or even weights being lifted by a weight lifter all possess kinetic energy. Heat, light, and sound are also forms of kinetic energy. Heat energy is the energy of the motion of the particles that make up a substance or object. Light energy is emitted (given off) when certain kinds of energy changes take place within the atoms of a substance; the movement of electrons within the atoms causes the emission of waves of light energy. Sound energy also travels in waves, causing the particles of the substances through which it travels to alternately be compressed and expanded (within a limited range).

Electricity is also a form of kinetic energy. It consists of a stream of tiny particles—electrons—flowing along a path.

Potential Energy

Potential energy is the energy of position as opposed to motion. For example, a ball held high in the air has potential energy. A yo-yo has potential energy before it is released. A barbell resting on the rack above a weight lifter's bench has potential energy. Each of these would exhibit kinetic energy in falling if it was released. Potential energy may be thought of as captured or unreleased energy.

Potential energy is sometimes stored energy. Stored energy may be thought of as the energy a substance or object possesses due to its composition (as opposed to position). Examples of stored energy include fuel and batteries. Fuels are substances whose chemical makeups store captured energy. (Substances whose atomic structures enable their use in nuclear energy processes are also called fuels, but they are fundamentally different in both nature and use.) Batteries are devices used for generating electricity by means of the chemical reactions of the substances within them; they store potential energy by virtue of the chemicals combined in them.

Relative Amounts of Kinetic and Potential Energy

Energy is the ability to do work, that is, change matter. It is possible to compare the amounts of energy represented in different situations or objects. This may be done by comparing the effects of their actions (kinetic energy) or the results that would occur if they were released to act (potential energy). For example, a moving train possesses more kinetic energy than a moving car, because more mass is being moved. A ball being held in the air by a person standing atop a building has more potential energy than a ball held by someone standing on the ground, because it will fall farther when it is released.

Energy Transformation

Energy changes back and forth between kinetic and potential forms constantly. It can even be said that one represents the other. For example, a barbell resting in the rack above a bench has potential energy, but may also be said to represent the work that was done to lift it to the rack. The kinetic energy of a traveling vehicle can be said to represent the potential energy of the fuel its engine is burning. Because energy cannot be created or destroyed—only changed in form—any form of energy necessarily came from another, it from yet another, and so on. Likewise, any form of energy may undergo innumerable changes in form in the future.

HEAT ENERGY

Heat and States of Matter

Heat energy is the internal energy of an object. Everything is made up of atoms or molecules, and these tiny particles are constantly in motion. It is this motion that results in the heat energy of an object or a substance. In solid substances the particles' movement is quite limited; it resembles what we might call vibration. In liquids the particles slip and slide randomly past one another (this is why liquids flow). The particles of gases move so freely that gases must be contained in order to keep them from dispersing and mixing with the atmosphere.

That the movement of the particles making up a substance has something to do with heat should be obvious—for example, consider these everyday occurrences. An ice cube is frozen (solid) water. If it is put in a warm place, it will melt; it will warm up and become liquid water. If water is to be boiled—changed from a liquid to gaseous state—heat must be applied to make it much warmer.

We may therefore say that for any given substance, less heat energy is contained in its solid state than in its liquid state and less heat energy is contained in its liquid state than its gaseous state. The amounts of heat in each state differ from one substance to another. For example, much more heat is required to melt iron than to melt ice. The heat content of any substance at a given state is one of its properties (unchangeable characteristics).

Heat Transfer

Heat energy always flows from areas of higher concentration to areas of lower concentration. This is why a hot object (for example, a pie just baked in the oven) cools off and eventually reaches the same temperature as the air around it; its heat is dissipated into the air as it flows from where it is highly concentrated (the pie) to where it is less concentrated.

There are three ways heat can be transferred from one place or object to another. The most familiar of these is conduction, whereby heat flows through an object. When a fire in a fireplace is stirred with a poker, the person holding the poker feels the poker growing warmer as he/she holds it; this is conduction. Conduction also takes place when the pie cooling on the kitchen counter warms the surface on which it rests. Conduction takes place in solid objects. Convection is the heat transfer that takes place when liquids or gases are unevenly heated. For example, a heater in a room creates an air flow pattern by warming the air right around it. This warmed air expands and rises, causing cooler air to fill its space around the heater. As this air is warmed and rises, the once-warm air sinks because it has cooled. A circular pattern of air flow is created; the heat energy from the heater is thus distributed. Convection takes place in liquids and gases. Radiation is the third way in which heat is transferred. (This is not the same as radiation from radioactive materials.) Under certain conditions, atoms give off energy in the form of infrared waves. These waves then travel through either empty space or materials (such as the atmosphere) and are converted to heat energy when they strike objects. The objects absorb the energy of the rays and their particles' motion is increased; that is, the objects' heat energy is increased. This is how the sun warms the earth, as well as why you feel heat when you hold your hand near a light bulb that is turned on.

Use of Heat Energy

The radiant energy of the sun is the most essential energy source to the earth. Without the heat gained when the sun's rays strike the earth, our planet would be entirely too frigid to support any known life forms.

It is essential to most of the processes we conduct each day that we be able to manipulate heat energy. Just think of what human life must have been like before we harnessed fire. Fire is essentially a tool that enables us to chemically change fuels and, in so doing, convert the energy stored in their molecules to heat energy which we can use. Although we do not burn nuclear fuels, the nuclear reactions that take place release energy in the form of heat. The "product" we seek when we use fuels of any kind is heat.

Heat and Temperature

Heat energy is not the same thing as temperature. Temperature is a method we have invented to express the "hotness" or "coldness" of objects or materials. While temperature is related to heat energy content, they are not equivalent. For example, a cup of boiling water has a temperature of 100°C, as does a huge pot of boiling water. It is obvious, however, that the pot of water contains more heat energy than the cup of water. (Think of how long it would take the pot of water to give off enough heat to have a temperature equal to that of the room's air. The cup of water would cool off much more quickly.)

Temperature Scales

There are two different temperature scales in common use. Both were developed in the 1700s. For everyday purposes in this country, we use the Fahrenheit (F) scale, in which 32°F and 212°F are the freezing and boiling points, respectively, of water. Elsewhere in the world and everywhere in scientific fields, the Celsius (C) scale is used. In the Celsius scale, 0°C and 100°C are the freezing and boiling points, respectively, of water. (Notice that the size of the degrees is not equivalent in the two scales.)

Thermometers

Temperature is measured by devices called thermometers. The most common thermometers are those that use mercury, a silvery metal that is liquid at room temperature, or colored alcohol. The principle on which they work is that the volume of a given mass of liquid is determined by its temperature. Here is how a thermometer works: A certain amount of colored alcohol or mercury is enclosed in a narrow glass tube. If the temperature to which it is exposed is warm, it will absorb heat and expand, occupying more of the narrow tube. If the opposite is true, the substance contracts and occupies less of the tube. The tube is attached to a backing that has degree marks so that temperatures can be read.

LIGHT ENERGY

Definition

Light energy is the form of energy that travels in waves and may be detected by the unaided human eye. There are many, many different kinds of wave energies; visible light is only a small fraction of the range of energy waves, which includes X-rays, radio waves, infrared (heat) waves, and others.

Properties of Light

Light travels at a constant speed of 300 million meters (over 186,000 miles) per second in a vacuum (where there is not even air). Waves of light travel in straight paths. They travel through some materials and through empty space. For example, light from the sun travels through space and our atmosphere.

There are several possible results when light rays fall upon matter. Light is reflected or bounced back when it strikes a shiny surface. This is what happens when light strikes a mirror. The reflected objects appear to be behind the mirror because of how the light is reflected. When light passes from one medium to another, its rays are bent or refracted. An object under water appears to be in a slightly different place from where it really is, and a straw or pencil placed in a glass of water appears to be somewhat bent, because the light rays our eyes sense are slightly bent when they pass from the air into the water. They bend because the differing densities of the media through which they pass cause a slight change in their speed. Light may also be absorbed. In fact, different materials absorb light differently.

Light and Color

Visible, or white, light—such as sunlight—is a combination of several different kinds of light waves. These waves are the different colors of the spectrum and can be seen using a prism. The prism refracts each color a little differently, splitting them apart so the colors—red, orange, yellow, green, blue, and violet—can be seen. A rainbow is the result of raindrops acting as prisms. When we see colors, our eyes are sensing the light reflected by what we are observing. An object that appears black is absorbing all the colors of the spectrum; none are reflected. An object that appears white is reflecting all the colors; a blue sky is reflecting blue light waves; and so on. Our eyes even have the ability to pick up different colors simultaneously and in varying combinations, allowing us to perceive different shades and tones of colors.

Sources of Light

Light may be emitted from either natural or manmade sources. The sun, of course, is the chief source of light on earth. The moon simply reflects the sun's light. A very small amount of starlight from stars other than the sun reaches us; although many of the stars visible on earth would dwarf our sun, they are so far away that we receive only a miniscule amount of light from them.

Burning any fuel also yields light energy. Because we rely on electricity to provide our lighting now, we no longer use candles or oil lamps on a regular basis. Light emitted from electrically powered lighting devices is the result of the same phenomenon that causes light emission from burning fuels. When atoms absorb energy under certain conditions, their outermost electrons are temporarily boosted to higher energy levels. Upon returning to their normal levels, they give off the excess energy in the form of light.

In incandescent light bulbs, an electric current is run through a filament made of a certain type of metal. The energy of the electricity causes the filament to heat up; light is emitted as a secondary result. In fluorescent lights, the electricity is run through a gaseous mixture in the tube; the gases then give off energy which bombards the coating on the inside of the tube and causes it to emit light. (The result is much more light for less electricity, for there is much less heat energy to be "wasted.")

ELECTRICITY

Definitions

All matter consists of atoms, and every atom contains at least one electron and at least one proton. An electron is a negatively charged particle of matter; a proton is a positively charged particle. These small particles have equal but opposite charges. The proton does not move freely from the center (or nucleus) of an atom, but an electron, which has practically no mass, does. Electrons move in orbits about the nucleus. Atoms are usually neutral. This means that they have the same number of protons as electrons (i.e., the same number of positive and negative charges).

There are two kinds of electricity—static electricity and current electricity. Static electricity consists of electrons that are temporarily displaced and that are not flowing in a stream. Current electricity consists of a stream of flowing electrons. Static electricity has few uses, but current electricity is useful in many ways.

Static Electricity

When we use the term "electricity," we are referring to the energy form that is so important to us—current electricity. When we mean "static electricity," we use that term. Static electricity is the type of electricity responsible for the "shock" you feel when you touch another person or a metal doorknob after walking across carpet on a cold day. It causes the "static cling" in the clothes dryer that makes clothes stick together. Static electricity is the result of atoms becoming temporarily charged when items are rubbed together. For electricity to be put to some use, there must be a path over which electrons can flow and a force to push them along the path.

Current Electricity

Current electricity is a flow of electrons. Current electricity cannot be seen, but it is one of humanity's most useful forms of energy. We recognize this form of electricity by what it does for us. It heats and cools our homes, schools, and other buildings. It gives us light and powers our appliances. It brings us television, radio, and telephone. It is instantaneously available, convenient, and clean.

A simple way to understand electric current is to use water as a model. Imagine water behind a dam. The water has energy—the ability to do work—but as long as it remains behind the dam, the energy is simply being stored. Recall that an electron is a negatively charged particle. Excess electrons on a negatively charged object are like the water behind a dam; the electrons have energy, but that energy is being stored. If the electrons were flowing along a path, they could form an electric current and do work, just as the water behind the dam could do work, if it were allowed to flow. It could turn the blades of a water wheel or turbine or could act upon the land through which it would flow.

Current Flow

What makes electrons move? Electrons move if there is a path for them to follow and if there is a force to move them along the path. The force that causes electrons to flow is called electromotive force. To keep electrons moving along a path, something must provide the force. This is what a battery or generator does. These devices convert another form of energy to electrical energy by supplying the force to push electrons along the path. A battery is composed of chemicals which react together. The chemical change that takes place releases energy in the form of electricity. A spinning generator's mechanical energy is converted to electrical energy by employing principles of magnetism and electricity.

For electrons to flow, their path must be composed of materials through which they can flow easily. These materials are called conductors. Water is a good conductor of electricity, as are metals. Metals make good conductors because the atoms in metal objects share free electrons, which easily move from atom to atom. Metal wires made to conduct electricity carry electric current as electromotive force, supplied by a generator or battery, pushes electrons along from atom to atom. Again we can use the analogy of water. Electrons are moved along through a conductor the way molecules of water are pushed through a garden hose when the faucet is turned on and off. The molecules are bumped along by the pressure of the water when it is turned on, similar to the way electromotive force pushes electrons along a conductor.

Materials that resist the flow of electricity are called insulators. Examples of insulators include glass, rubber, plastic, wood, and other nonmetallic materials.

For an electric current to keep flowing, the conductors along which it travels must be arranged into a circuit. A circuit is a path followed by electrons from an electricity-generating source through the point of use and back to the source. Current cannot travel only part of the way around a circuit. A circuit must be "closed" (uninterrupted). If a gap is created in the circuit, the flow stops immediately. This is how a switch turns electricity on and off. Turning a switch off creates a gap in the circuit, while turning one on completes the circuit. Electrons travel through wires at almost the speed of light, so an electric circuit is completed almost instantaneously.

Generating Electricity

There is no natural source of usable electric current. Over hundreds of years of experimentation, people developed ways to produce and use electricity. The production of electricity is called generation.

Generating electricity is not the creation of energy, since energy cannot be created or destroyed. We convert another form of energy to electrical energy. Electricity can be generated from many forms of energy; but to generate the large amounts of electricity required by industrialized societies, huge generators in power plants convert the mechanical energy of steam (produced by heat from nuclear fission or burning fossil fuels) or falling water to electrical energy. Either can be forced against the blades of a turbine. The high-speed revolutions of the turbine cause an electric current to be produced when this spinning cuts rapidly and repeatedly through the magnetic field of an electromagnet within the generator. (For more information on the generators used in the Tennessee Valley, see the factsheets on hydropower, energy from coal, and nuclear energy.)

Electricity and Magnetism

Magnetism and electricity are related. Electric current can induce magnetism; the magnets it creates are called electromagnets. Magnets can induce electrical current and are used in the generation of electricity. Many electrical devices depend upon magnetism in order to work.

Over 150 years ago, a British scientist (Michael Faraday) invented the first generator. He had discovered that an electrical current was produced in a coil of wires when a magnet was turned inside the coil. His small generator sat on a table top and was turned by hand. It produced a very small current.

Today we need large amounts of electricity. The generators in the power plants that produce our electricity have powerful magnets, very large coils of wire, and a very high revolution rate. The more powerful the magnet (that is why we use electromagnets), the greater the number of turns of wire, and the higher the rate of spinning inside the generator, the more electricity can be produced. Our generators consist chiefly of two giant wire-wrapped rings, one inside the other. The inside ring—the rotor—is electromagnetized and spins inside the stationary ring—the stator. As the rotor spins (very rapidly), the stator's wire coils repeatedly break the lines of force of the magnetized spinning rotor. An electrical current is induced in the stator. It is this current that is transmitted out of the power plants.

Delivering Electricity

Electrical power plants are often located far from the point where the power they generate will be used. The distance may be only a few miles or it may be hundreds of miles. The electricity must be sent, or transmitted, from the power plants to homes, businesses, industries, and other users of electricity over transmission lines or wires. Although the wires transporting the electricity are conductors, there is some resistance to the flow of the electrons making up the electric current. This causes some of the current's energy to be lost in the form of heat. By increasing the voltage, or "push" of the electrons, the energy lost in transmission is reduced. The increase in voltage is accomplished by devices called "step-up" transformers in the power plants' switchyards. High-voltage transmission lines go out from the power plants to industrial sites, cities, and towns.

Before very high-voltage electricity can be used, it is "stepped down" to a lower voltage through transformers at large power substations. Many industries use higher voltages than other users; they often use electricity directly from a substation. The electricity for most other customers is sent out over distribution lines from substations. Distribution transformers (on power poles or underground) are used to reduce the voltage still more to the level used in homes and businesses. Low-voltage power enters homes (for example) through a fuse or circuit box, and wires carry the current to switches and plugs. As we switch on the lights or plug in and turn on appliances, the process of generation, transmission, distribution, and utilization is completed.

Electricity and Safety

Electricity out of control can be dangerous. Even electric circuits can become hazards if they are improperly installed or used. Overloading wires with too much current can cause the wires to get hot enough to burn off their insulation, causing fire. One way to protect ourselves and our property from overloaded wires is the use of fuses. A fuse shuts off the flow of electricity if a wire is carrying too much current.

Proper caution is required in handling electrical appliances and outlets. This is particularly true if part of the user's body is wet or he/she is standing in water, because water is a good conductor of electricity. Electrical safety rules spell out ways to avoid the contact of appliances and water, the contact of conductors with sources of electricity, and the improper or unsafe use of appliances, cords, and outlets. When electricity is improperly used, current can travel through a human body. Electrical shock can be fatal; even household current can cause death.

HYDROPOWER

Energy From Water

Moving water has immense strength. Rain, ocean tides, streams, and rivers carve the land. Floods and tidal waves can cause widespread destruction, altering land and its inhabitants' lives. This power of water can be harnessed as a source of usable energy. People have been using water as a source of energy for many centuries. The energy of water was first harnessed in simple water wheels for grinding grain or pressing oil from olives. Today modified water wheels convert the energy of moving water into electrical energy. Hydroelectricity is an important element of the Tennessee Valley Authority (TVA) power system.

Generating Hydroelectricity

In order to use the force of flowing water to produce hydroelectricity in commercial (large) quantities, a dam is built across a stream or river to create a storage area or reservoir that provides a year-round supply of water. Water cannot create power unless it is flowing or falling from a high place to a lower place. Hydroelectric dams are constructed so that gravity pulls the water from the reservoir downward through passageways called penstocks. The water flows through the penstocks and strikes the blades of the turbines. Turbines are modern-day, highly efficient water wheels. The great force the water exerts causes the turbines to rotate. The rotating turbines spin the generators, producing electricity.

The amount of water that flows onto the turbine blades is regulated by control gates that are opened to varying degrees depending on the quantity of water needed. When the gates are closed, no electricity is produced; the more water the gates allow to flow through the penstocks, the more electricity is generated. The generation of hydroelectricity is easily regulated by controlling the flow of water through a dam.

Hydroelectricity Supplies

In the 1930s, hydropower supplied as much as 30 percent of the United States' energy requirements. Today less than 12 percent of the Nation's energy is supplied by hydropower. Actually, more hydroelectricity is being produced than ever; its proportion is lower because we now use much greater amounts of energy from other sources (chiefly fossil fuels).

Weather affects the production of hydroelectricity. In 1984, hydropower provided 20 billion kilowatthours of electricity in the Valley, or 18 percent of TVA's total output. This amount declined during the dry mid- and late 1980s because rainfall levels affect the amount of water available for hydroelectricity; production increases in rainy periods and decreases in dry periods. Storing water in reservoirs helps even out the differences in generating capacity between wet and dry periods, but there is a limit to how much water can be drawn out of reservoirs for generation when there is little water coming into the lakes. In very dry years, the production of hydroelectricity can drop to about 10 percent of the power system's total output, a very low percentage. Despite these fluctuations, the Valley is still dependent on TVA's hydropower system for the production of inexpensive electricity.

Hydroelectric Dams In The Valley

Of TVA's 29 hydroelectric dams, 9 are on the Tennessee River, 19 are on tributary systems in the eastern and southern portions of the Valley, and 1 is in the Cumberland River basin. There are also dams in the Valley region that are owned by the U.S. Army Corps of Engineers and the Aluminum Company of America (ALCOA) which contribute hydropower to the TVA system. TVA helps to operate these facilities but does not own or manage them. Most, though not all, of the major dams in the Valley have hydropower generating plants.

Pumped-Storage Hydropower

When many people use electricity at the same time—early in the morning, for example—the electric supplier must be able to meet this “peak demand.” TVA has two ways to do this. One is gas- or oil-fired combustion turbines, which can be started quickly but are very expensive to operate. The other is the Raccoon Mountain Pumped-Storage Plant, located near Chattanooga, Tennessee. Here, water is pumped from the Tennessee River at night (when power demand is low) to a large mountain-top reservoir. When power demand is high, the water is released to spin generators as it falls 1,000 feet through tunnels within the mountain to return to the river below. Operating at maximum capacity, the plant can instantly supply as much electricity as 13 dams with the capacity of nearby Chickamauga Dam. This method of meeting peak demands helps keep consumers' electricity costs low.

Cost of Hydroelectricity

Hydroelectric dams are the TVA power system's cheapest producers of energy. Because hydroelectricity production requires no fuel, there is no fuel cost to increase the price of hydroelectricity. For example, in 1988, a dry year, the cost per kilowatt-hour of generating hydropower in TVA's dams was about one-half cent per kilowatt-hour (kWh), compared to about 1.9 cents per kWh for coal-generated power. (Costs for hydropower are lower in years in which more rain falls.) The benefits of hydroelectricity's low cost are awarded only to residential power customers; this is one reason residential rates in the Valley continue to be among the lowest in the Nation.

Hydropower and the Environment

Hydroelectric power is a clean source of electricity because no fuel is burned and no waste produced. As with any energy-producing technology, however, there are environmental problems associated with the production of hydroelectricity.

The main environmental problems associated with hydroelectric generation have to do with the ways dams change the environments of river valleys. Dams change river valleys into lakes, interfering with the natural habitats of aquatic and land plants and animals. They change chemical characteristics of the water (e.g., increasing nitrogen in the more slowly flowing water). Not only are the lands behind the dam flooded, but downstream waters and lands are also changed. Dams also affect people. During the years in which TVA was building major dams, the agency had to move thousands of families from lands needed for the reservoir system. More than a million acres of land were covered by the lakes. Some of this land was valuable farmland.

One problem caused by hydropower production in the Valley is lower levels of dissolved oxygen in the water flowing through the dams. This causes problems in aquatic habitats below them. TVA is trying several different approaches to help solve these problems, boosting oxygen levels and benefiting (in particular) the game fish species inhabiting the rivers below the dams.

Despite the drawbacks, hydropower is one of the least environmentally hazardous means of generating electricity. The water is used for the energy of its flow only; it is returned to the river after its energy spins the turbines.

The Future of Hydropower

The growth of commercial hydropower will be limited in the future because of the lack of additional sites suitable for large power plants; however, many power companies are considering renovating existing or retired hydropower facilities. Rising power rates make these hydropower plants look promising again. It is also possible that smaller-scale hydropower facilities may play a role in the future of hydroelectric generation in the United States.

ENERGY FROM COAL

Electricity from Coal

The Tennessee Valley Authority (TVA) originally "electrified" the Valley using hydroelectric power. Demand for power soon increased beyond what could be met by hydropower alone. In the 1940s, TVA began building a series of large coal-fired plants that would eventually account for much more generating capacity than the hydroelectric plants. These power plants were some of the largest in the world when they were built. Today TVA's 11 coal-fired plants are producing most of the electricity generated in the Valley. In fact, during the recent drought (when hydropower was limited) and the times that TVA's nuclear plants were not in service, coal-fired generation accounted for about 90 percent of the electricity generated in the Valley.

Coal is burned so that its heat may be used to boil water, changing it into steam. Jets of steam turn turbines that drive generators, producing electricity. Power plants may produce heat to make steam in different ways. For example, nuclear plants create heat by splitting uranium atoms while other plants burn natural gas or fuel oil.

Geology of Coal

Coal is the end-product of the accumulation and burial of large amounts of plant and other organic material over extremely long periods of time. Along with oil and natural gas, coal is commonly called a fossil fuel. This distinction is appropriate because each time we burn coal we are using energy from the sun that was stored by plants millions of years ago. (TVA refers to its coal-fired plants as fossil plants because coal is a fossil fuel.)

The U.S. has vast coal deposits. We have about one-third of the world's known reserves. Coal deposits account for nearly 90 percent of the known reserves of the three fossil fuels (coal, oil, and natural gas) in the U.S. In the Tennessee Valley area, extensive coal fields are found in Kentucky and Virginia; Alabama and Tennessee also produce significant amounts of coal.

There are four different types of coal—anthracite, bituminous, subbituminous, and lignite. High heat content and the amount of reserves located in the Valley region are the reasons bituminous coal is the only type of coal used in TVA's coal-fired power plants.

Mining Coal

Coal is removed from the earth primarily by two methods—surface mining and underground mining. Surface mining is used to extract coal that is within 100 to 200 feet of the earth's surface. More than half of our Nation's coal comes from this type of mine. Most of the coal mined in the Valley region is taken from surface mines. Underground mining is used to extract coal that is more than 100 to 200 feet deep in the earth. Underground mining, however, is much more expensive and dangerous than surface mining.

When coal is mined by surface methods, the overlying earth and vegetation are removed to reach the coal deposits. This is why surface mining is often called "strip mining." After the coal is removed, the landscape is scarred. Restoring or reclaiming the land is necessary in order to prevent the environmental problems that result when the land is left to heal itself. Reclamation requires careful planning even before mining begins. It can be expensive and time-consuming. Most mined lands were simply abandoned before laws were passed requiring miners to reclaim the land they mined. Because the problems created when mined

lands are not reclaimed can be so serious, some mined land was reclaimed to some degree even before laws required it. TVA has been developing methods of reclaiming coal-mined lands since the 1960s. The Federal Surface Mining Control and Reclamation Act of 1977 now dictates that miners must reclaim the land, restoring its beauty and usefulness after the valuable resource has been extracted.

Coal and the Environment

There are several environmental problems associated with mining coal. Mining, especially by surface mining methods, can create water quality problems from soil erosion and the resulting sedimentation of streams. Acid-forming rocks disturbed by mining can cause acidic pollution in streams. Reclamation practices are designed to control these problems and minimize their effects on the environment.

Burning any fuel can create air quality problems. All fuels (except nuclear fuels, which are not burned) are primarily composed of carbon. This is especially true of coal, because the processes which transform ancient organic matter into coal drive out most of the other substances, leaving a material that is almost entirely carbon. Burning is essentially a process that combines oxygen (from the air) with the material(s) making up the fuel. The two main products of burning fuels are carbon dioxide and water. The water presents no environmental problems. The plume of "smoke" released from power plant smokestacks is almost entirely water (steam). Carbon dioxide is odorless and invisible, not at all harmful in itself. In recent years, however, scientists have begun to be concerned about the huge amounts of carbon dioxide we have been adding to the earth's atmosphere for the last several decades. The "greenhouse effect"—wherein the earth's climates are changed due to the increased trapping of solar heat energy by atmospheric gases (mostly carbon dioxide)—could have drastic effects on both the natural environment and manmade environments (such as farmland and coastal cities).

Fossil fuels contain small amounts of sulfur and nitrogen, which combine with oxygen when they are burned. Sulfur and nitrogen oxides from power plants, industries, and vehicles are converted in the atmosphere to compounds which combine with moisture to form acid. Coal-fired power plants are the chief source of the acids making up acid rain in many parts of the world. Acid precipitation is a growing concern. It is detrimental to water quality, land habitats and the plants and animals living in them, and to manmade things such as buildings and automotive finishes. Research is continuing as to how emissions of acid-forming oxides can be minimized, but two partial solutions are to burn low-sulfur coal and to equip power plants and factories with devices called scrubbers, which remove the acid-forming substances from smokestack emissions.

Coal also contains small amounts of material that will not burn. Some of this material is given off in tiny particles called fly ash, which can be carried out of the stack in the gaseous emissions. Most of these particulates can be captured by pollution control devices. In fact, the sooty smoke of the coal-burning plants of years ago is now prohibited by air pollution control laws.

TVA has been a leader in developing technologies to control emissions and has made a solid commitment to reducing air pollution from its coal-fired plants. These measures are expensive but are necessary to preserve environmental quality.

The Future of Coal

Advances in technology show promise in helping solve the problems of using coal and assuring that coal will continue to be a major energy source in the future. Methods of burning coal more efficiently and cleanly (clean coal technology) are being investigated. Different ways to use coal as a fuel are being developed. Coal gasification, for example, involves converting coal to a gas for easier transport and cleaner burning. Coal liquefaction involves converting coal to a liquid fuel such as methanol or gasoline.

Many experts see coal as our "energy ace-in-the-hole." The U.S. has far greater supplies of coal than any other fuel. Coal is playing a role in lessening our dependence on foreign energy suppliers, and, as the world's oil and gas supplies are reduced, coal will become an even more important energy resource.

NUCLEAR ENERGY

Energy From Nuclear Fission

All nuclear energy today is produced through nuclear fission, the splitting of the nuclei of certain uranium atoms. Heat energy is released each time an atomic nucleus is split. The production of nuclear energy takes place in a nuclear reactor, a system designed for controlling the fission process and making use of the energy it releases. The heat energy is used to boil water. The steam that results is used to rotate turbines, which then spin generators, producing electricity. The process is very similar to that of coal-fired plants, except for the source of the heat energy.

Nuclear Energy in the Valley

When compared to most other energy resources, nuclear energy has a short history. The first commercial nuclear reactor for electric power generation began operation in 1957 in Shippingport, Pennsylvania.

Energy demand in the Tennessee Valley increased greatly during the 1950s and 1960s, causing the Tennessee Valley Authority (TVA) to plan to use nuclear power plants as major suppliers of energy. At the time, electricity from nuclear power was cheaper than electricity from coal because nuclear fuel was so inexpensive. The Arab oil embargo in the early 1970s, however, brought on the "energy crisis" and set off a period of high inflation. Americans responded by using less energy than had been predicted. Because of the slower-than-expected rise in electricity demands, the increased efficiency of electrical machines and appliances, and greatly increased costs in nuclear plant construction, nuclear plants in the planning and construction stages have been deemed unnecessary and have been cancelled.

TVA has two nuclear plants, Browns Ferry Nuclear Plant near Athens, Alabama, and Sequoyah Nuclear Plant, near Chattanooga, Tennessee. These plants were successfully operated for several years, but were shut down in 1985 because of serious technical and management problems. Sequoyah Nuclear Plant is back "online" now; work continues on Browns Ferry.

Nuclear Fuel

Uranium, a metallic element recovered by mining, is used to produce nuclear energy. Most of the United States' uranium reserves are in western states. Uranium contains tremendous energy potential. A piece of uranium fuel the size of a golfball has energy equivalent to that of 168,000 gallons of oil. Only one form of uranium, the isotope called U-235, can be used as fuel in nuclear power plants. Of all uranium, only 0.7 percent (or 7 out of 1,000 pounds) is U-235. The rest is another isotope, U-238, which does not undergo fission and cannot be used as fuel.

The nuclear fuel cycle begins with the mining of uranium ore. This is followed by separating the uranium from other materials in the ore. In order to use the uranium as fuel, the concentration of the usable uranium (U-235) must be increased relative to that of the useless uranium. This is called enrichment and is usually achieved by a process called gaseous diffusion. Enriched uranium contains a concentration of about 3 to 4 percent U-235.

Enriched uranium is then made into pellets about 3/8 inch in diameter and 1/2 inch long. The pellets are inserted end-to-end into long tubes called fuel rods that are bound together into fuel assemblies and shipped to nuclear power plants. A reactor requires about 200 fuel assemblies in order to operate. About one third of the assemblies are replaced at the end of each 18-month fuel cycle.

When the used, or spent, fuel is removed from the reactor, it contains some leftover uranium and a variety of highly radioactive materials that are called fission products (because they are the result of the nuclear changes that have taken place). At the present time in this country, spent nuclear fuel is being stored at the power plants in special pools filled with chemically treated water. Plans for its permanent disposal await Federal action, and research continues into methods of disposal. It is nuclear waste from power plants and defense projects that comprises most of the high-level nuclear waste about which debates now rage.

Nuclear Plant Safety

One common concern about nuclear power is safety. To address this concern, we may examine the nuclear industry's safety record. Even if one considers the 1986 nuclear accident in Chernobyl (in the Soviet Union), nuclear power has a much better safety record than any other commercial process of energy production. The Chernobyl accident served to reinforce the emphasis on safety that is the primary concern of the nuclear power industry in the U.S. There are other points about reactor safety that should be emphasized. One is that a nuclear plant cannot explode like a nuclear bomb. A bomb must contain 85 percent fissionable U-235; fuel rod U-235 concentration is only 3 to 4 percent. Another point is that there are risks involved in any method of generating electricity and, for that matter, in everything we do. Statistics suggest that risks from nuclear energy are quite small compared to other risks we accept. Finally, nuclear power plants operate under tight security and have multiple safety systems.

Nuclear Power and the Environment

A chief concern about nuclear power is radiation, either released from plants themselves or from their radioactive waste. Although nuclear plants release small quantities of radiation into the atmosphere, it is far less than background radiation (i.e., radiation from naturally radioactive materials and from cosmic rays entering the atmosphere). The public is protected from radioactive wastes by careful handling and storage of these materials. The government regulates all handling, storage, and transportation of these wastes. Low-level radioactive wastes are sealed in steel canisters and shipped to licensed commercial burial grounds. High-level radioactive wastes are usually stored onsite at power plants or defense facilities.

Waste heat is another problem associated with nuclear power. Steam-turbine power plants (nuclear and coal-fired plants, for example) require large amounts of water for cooling as well as power generation. Heat released into bodies of water can be harmful to aquatic life, so cooling towers are built to release the heat into the atmosphere rather than the lake or river on which the plant is located. Using waste heat could eliminate adverse effects on the environment; for example, warm water could be used for heating greenhouses to increase agricultural production.

The Future of Nuclear Energy

Nuclear power is an important source of energy in the Valley. The next few years are expected to be a period of economic growth, and many experts believe that nuclear energy will continue to be needed to help meet the Nation's energy demands over the next few decades. As the environmental concerns associated with using fossil fuels—for example, oil spills, acid rain, and the greenhouse effect—continue to grow, nuclear power may become a more attractive option for more utilities and the customers they serve.

SOLAR ENERGY

Importance of the Sun's Energy

The sun is the earth's primary energy source. Without heat energy from the sun, the earth would not be habitable; its temperature would be approximately -450°F. Without light energy from the sun, photosynthesis could not take place; there would be no green plants and, therefore, no animals and no people.

The warmth and heat of sunshine are not the only forms in which solar energy is important to us. The heating of the earth's surface and atmosphere generates wind, waves, rainfall, and ocean temperature differences. All these phenomena of nature are considered to be indirect forms of solar energy and can be used to generate electricity. Hydroelectricity is commonly used now. Wind-powered generators have limited use at this time. Waves and ocean temperature differences have potential as future large-scale generators of electricity.

Even the energy from most of our fuels can be traced back to solar energy. The sunshine of millions of years ago supplied the energy that is stored in the fossil fuels that are our chief energy resources in the twentieth century. For most of human history, wood was the primary fuel. It remains an important energy resource today. Trees and other plants store the sun's energy through the process of photosynthesis. We release this energy when we burn them or when we burn other fuels made from them; for example, liquid fuels can be made from many agricultural crops.

As we have developed more and more energy-using technologies, our demands for energy have soared. We are using our resources, especially fossil fuels, at an alarming rate. It has become clear that we must develop new energy resources and technologies. Because the sun's energy is inexhaustible, free, and nonpolluting, it is a particularly attractive energy option. We are re-examining old ways of using solar energy as well as developing new ways.

Ancient Uses of Solar Energy

Use of the sun's energy is not new. People have always used the sun for light and for heat to dry clothing and food and to warm their dwellings. Cities in ancient Greece and in Asia were designed so that their streets ran in north-south and east-west directions, giving homes along these routes a southern exposure and making the most use of the sun's warmth. Courts of the Roman Empire passed laws to guarantee homeowners the right to unobstructed sunlight. In North America, long before European colonization, Southwestern Indians constructed entire communities that made use of solar heating.

Solar Energy Systems

Though there are many variations, there are only two basic types of technology for using the direct rays of the sun—active and passive solar energy systems. Active systems rely on mechanical devices such as fans, pumps, or motors to collect and distribute solar-gained heat. Passive solar systems, unlike active systems, use few or no moving parts. Instead, passive solar heating is accomplished by designing and orienting (facing) buildings in such a way as to allow them to benefit most from direct sunlight.

Active systems are used for heating water or inside air. Active systems use solar collector panels made of metal, glass, or plastic that are installed on the roof of a building or elsewhere outside it. These panels capture the sun's heat in air or water which is transported to various points of usage. Active solar technologies include solar water heaters, solar heat pumps for heating and cooling, and several other types of systems that use solar energy to power cooling equipment. Larger-scale active systems that use the sun's heat to produce steam with which to generate electricity are also being developed. These are expensive, however, and are practical only in desert areas.

Passive solar technologies tend to be simpler and less expensive than active systems. Many are simply improvements on very old ideas. Large windows are placed on the south side of buildings, and window space is minimized on the north. Interior walls or floors are specially designed to retain heat. Buildings designed for maximum solar heat gain in winter also include simple design elements which help cool them in summer. For example, overhangs and shade plants block out the summer sun's rays, preventing unwanted solar heat gain in summer.

Passive solar technologies are more easily used by individual homeowners or builders than are active systems. For example, people constructing new buildings or remodeling old ones can incorporate passive solar design elements into their plans. Existing buildings can be retrofitted—modified or added to—in order to take advantage of solar energy.

Electricity From the Sun

The solar or photovoltaic cell is an example of a different kind of solar technology. These cells convert light directly to electricity. Solar cells are frequently found in hand-held calculators. They are also used to supply power to satellites and other space vehicles. Large-scale use of solar-generated electricity is not practical at the present time. For instance, it would take a 20- to 30-foot panel of such cells atop a residence and many storage batteries inside to provide ample electricity for an average household. At present, the cost of such systems is extremely high. There are, however, uses for this technology; for example, solar cells can power communication devices where there is no other source of electricity, as is true in many remote areas and in less developed countries. More use may be made of solar electricity in the future as the technology is improved.

Challenges to Solar Power

The major challenges to using more solar power include the lack of satisfactory means of energy storage and concerns about flexibility and economics. Because no power can be produced when the sun is not shining, scientists must develop cost-effective methods of storing solar power in order to supply energy whenever it is needed. The development of effective and efficient storage systems will be one key to the future of our use of direct forms of solar energy. As technologies improve, the use of solar energy will increase, and its cost will become more reasonable.

Advantages of Solar Energy

Using energy from the sun is attractive for a variety of reasons. The environmental and safety hazards associated with fossil fuels and nuclear energy do not apply to solar energy. Solar energy is clean, free, and abundant. Technologies and methods of using solar energy can be as simple as the proper use of window shades or blinds or as complicated as a building designed with active solar energy systems. Every person can make better use of the sun's energy. In so doing, we can reduce our energy costs, use fewer nonrenewable energy resources, and increase our energy independence.

ENERGY CONSERVATION

Definition

Energy conservation can be defined as the wise and efficient use of energy. The wise use of energy involves judgments about energy use (i.e., use of energy resources). It may mean changing wasteful habits and making energy use choices based on an awareness of the need for energy conservation.

Another aspect of energy conservation is the efficient use of energy. When we say we “use” energy, we mean we change it or harness it to do work. We can change (or convert) energy from one form to another, but energy can neither be created nor destroyed. Each time energy is changed from one form to another, however, some energy is “lost” as waste heat or some other form that does not contribute to the task for which the energy is being used. When a conversion process wastes a lot of energy, it is said to be “inefficient.” The inefficient conversion and use of energy costs money and wastes resources. We are finding ways to save energy by efficiently converting and using it. The wise and efficient use of energy means that the energy we use is used for the best purposes in the best way.

While energy conservation itself cannot be considered an energy resource, it can extend the length of time that the energy resources we presently use will remain available for our use. This is especially important in light of the fact that we currently get over 80 percent of our total energy from nonrenewable (not replenishable) fossil fuels like coal, oil, and natural gas. These resources will someday be exhausted; the less of them we use now, the more of them will remain for use in the future. Conserving our energy resources now buys time as we search for new energy sources and improve how we use present energy supplies.

Exactly how many and which conservation techniques are to be adopted varies from one location or climate to another and with the preference of individual energy users. Many energy experts point out that great reductions in energy consumption are possible without lowering our present standards of living. While some think this is too optimistic, it is true that many western Europeans, for example, enjoy comforts comparable to ours but use only about half the energy.

The Energy Crisis

Although the United States has only 6 percent of the world’s population, we use about 35 percent of the energy used in the world each year. Our energy consumption has increased dramatically during the 20th century. Between 1940 and 1970, the Nation’s demand for electric power doubled almost every 10 years. Our consumption of oil almost doubled in the same period. Our dependence on foreign energy suppliers increased, but we gave it little thought because energy was still apparently plentiful and relatively cheap.

Then the Organization of Petroleum Exporting Countries (OPEC) stopped its oil exports for several months in 1973. The huge increase in oil prices that accompanied the embargo forced us to look more closely at our energy consumption. We began to speak of an “energy crisis.”

Suddenly we were asked to change our lifestyles. We were urged to walk or carpool instead of driving; to reduce or eliminate electric lighting; to turn thermostats down in the winter and up in the summer; and to adopt a number of other energy-saving strategies. In short, we had to think about our energy consumption and take actions to lessen it.

Our Nation set a goal of independence from foreign energy producers. Although this goal was never realized, a national emphasis on energy conservation resulted. Conserving energy became a priority across the Nation. In the Valley, where electricity was abundant and cheap and therefore heavily used, conservation of electrical energy was made a special priority.

Conserving Energy

There are many things we can do to make energy usage more efficient which cost no money. Some examples are carpooling, driving less, making sure thermostats are set correctly, and turning off lights and appliances that are not being used. Not only do these things cost no money, but they actually save us money.

There are also things we can do or purchases we can make to conserve energy that require financial investments. The investments are then returned as savings on our energy bills. Home insulation is one good example of this. Insufficient amounts and/or unsuitable types of insulation are the leading causes of energy waste in most homes. By installing the correct amounts and types of insulation, consumers save significant amounts of energy in heating their homes in winter and cooling them in summer, not only saving money but also increasing their comfort.

Other measures that require expenditures in order to save energy (and money) include weather-stripping and caulking, automatic clock thermostats, and storm windows and doors. Appliance ENERGY GUIDE labels show the yearly energy cost of operating appliances and allow consumers to compare the energy costs of competing brands and models of similar size and with similar features. Many energy-efficient appliances cost less to operate over the long run even though their initial costs may be higher.

Purchasing nondurable goods with an eye toward the energy used in their production, use, and disposal is another way to conserve energy. Overly packaged one-use products represent a lot of wasted energy. Reusable and recyclable products conserve energy. Major purchases should also be made after consideration of energy consumption. For example, the energy efficiency of houses and automobiles should be a factor in our purchases.

Conserving energy should be practiced at every level of our society. Businesses and industries, governments, and communities should practice and promote energy conservation. This is unlikely, however, unless individual citizens and consumers are committed to conserving energy. The measures we take individually may be simple, but the cumulative result of many people taking such action is undeniably effective.

Conservation Success

It is estimated that electricity conservation programs in the Valley have saved over three billion kilowatt-hours of electricity. This amount of savings affects more than present utility bills; it also represents a savings of almost 1400 megawatts of generating capacity. Conservation efforts in the 1970s and 1980s will help power customers in the future because expensive new generating facilities have not been required to be built; financing power plant construction adds to utility bills for years to come. These savings also demonstrate that when energy is conserved, everyone is a "winner." Our personal pocketbooks benefit; the Nation benefits; and the environment benefits.

Despite the success of energy conservation efforts, our rate of increase in energy consumption is rising again. We have become complacent about conservation. The success of electrical energy conservation efforts in the Valley should provide an example to the Nation of what can be done when conservation is made a priority.

RENEWABLE AND NONRENEWABLE RESOURCES

Definitions

Resources are the supplies of useful or valuable things from which we make or obtain things we need or want. Everything must come from something else; resources are those things with which we begin. Many of our resources are materials from nature. The sources of energy we use are also resources. Some of them are materials and some are not. For example, energy from the sun is a vital resource to life on earth, and our industrialized society depends on the energy we get from coal, a fuel extracted from the earth.

Resources may be classified as either renewable or nonrenewable resources. Renewable resources are those that are replenishable or restorable. Nonrenewable resources are those that cannot be replenished or restored (or that require extremely long periods of time to be replenished).

Renewable Resources

Some of the energy resources we use are renewable resources. Solar energy is a virtually inexhaustible resource. The sun's energy also powers two other renewable sources of usable energy—the water cycle and the wind. It is the sun's heat energy that evaporates water from the earth's surface, so that it may fall again in some form of precipitation. Humans have used the energy of water flowing in streams, rivers, and oceans for many centuries. Water wheels once powered many mills for grinding grain, pressing oil from olives, and manufacturing textiles and metal products. Today, hydroelectricity—electricity generated using falling water's energy—is an important renewable resource around the world. The sun also powers the wind, which results when different air masses absorb different amounts of solar heat and therefore move about in the atmosphere. People used windmills and other wind-powered devices in many of the ways water wheels were employed. Before rural electrification, windmills were common across America's farmlands; they provided the mechanical energy to perform tasks like pumping water. Today, modified windmills can be used in locations where the winds are both strong and constant enough to generate electricity. Both water and wind are inexhaustible resources.

A more indirect source of solar energy is plant matter. Plants store solar energy in the chemical compounds they assemble using the energy of sunlight. Examples of using plants as energy resources include firewood and liquid fuels produced from plant material (e.g., alcohol fuels made from grain crop wastes). Plant materials are renewable resources because more plants can be grown. While farming and reforestation both require careful management of the land and crops, not to mention the time required, energy resources from plant materials can nevertheless be replenished.

Another energy resource that can be classified as a renewable resource is waste—anything that is discarded. Animals produce bodily waste. This waste material can be dried and burned as a fuel, as is common in some developing countries where firewood is in short supply. On a larger scale, such waste can be treated in devices called digesters; bacteria digest part of the waste matter, producing methane, which is similar to natural gas and may be used as a high-quality fuel. Some of the wastes we discard each day—primarily paper (and some plastics)—can be burned or chemically converted into another type of fuel to be burned. This energy may be used directly as heat or may be used to run a steam-powered generator.

Resources that are raw materials may also be classified as renewable or nonrenewable. Examples of renewable resources that are used for the products we need and want are primarily plant and animal products, such as foods and fibers.

Nonrenewable Resources

About 90 percent of the total amount of energy we use in this country comes from nonrenewable resources, chiefly the fossil fuels—coal, oil, and natural gas. These are called fossil fuels because they were formed over tremendously long periods of time from buried, partially decayed, ancient plants and animals. The energy stored in these fuels is actually traceable back to the sunlight that fell to earth in the lifetimes of the organisms. Although the kinds of processes that formed fossil fuels are ongoing in the world even today, fossil fuels are not renewable resources; their formation is far too slow for us to be able to look forward to renewed supplies of them in the foreseeable future.

Another nonrenewable energy resource is the uranium we must have for nuclear fission processes—the only way we currently can use nuclear energy to produce electricity in power plants. Uranium is not a very common element in the earth and less than one percent of it is usable in nuclear fission, but the amounts of energy available from it are incredibly large.

Nonrenewable resources we use as raw materials are primarily mineral resources such as metals and rocks. There are no more minerals being formed, so when we extract them from the earth, we are using irreplaceable resources. Soil, which is made from rocks, is another nonrenewable resource. The processes which weather rocks and produce soil are ongoing, but very long periods of time are required to make even a small amount of soil. We therefore consider soil to be a nonrenewable resource; once it is lost from a given area by erosion, the area suffers. (Of course, soil is not destroyed. It is simply moved around, often to where it is not useful and may be harmful; for example, eroded soil often clogs streams.)

Two of the fossil fuels are very important as raw materials. Coal and oil are used to make many of the products we use each day; they are important chemical resources. The most noteworthy use of these is the use of oil to make plastics. Most plastic products are designed to be used once, or for a short period of time, and then discarded. Each time we do so, we are discarding a very valuable nonrenewable resource. It has been suggested that someday our descendants may be amazed that we actually used these valuable chemical resources—fossil fuels—as fuels to be burned.

Implications for the Future

It is clear that we must be mindful of how we utilize resources, especially nonrenewable resources. In order to preserve supplies of nonrenewable resources, we must use more renewable resources and use nonrenewable resources as wisely and efficiently as possible. This is the essence of resource conservation. Supplies of nonrenewable resources will someday be small enough that we can no longer afford to obtain them and use them. We must begin to use more renewable resources (especially energy resources), and we must begin to recycle and reuse more materials.

ENERGY AND SOLID WASTE

Definitions

Anything that is discarded, useless, or unwanted is called waste. Wastes includes trash, tailings from mining and milling, unwanted parts of crop plants, scraps and debris from building and manufacturing, and many other materials. Most of the waste we dispose of is solid waste (as opposed to liquid or airborne wastes).

Waste Reduction, Reuse, and Recycling

We live in throw-away society. Americans buy, use, and discard an amazing array of products, many of which are for one-time use and almost all of which are packaged in several materials. Every phase of manufacturing, transporting, and merchandising these goods involves the use of energy. When used goods and/or their packaging are discarded, collected, and disposed of, more energy is used.

Reducing the amount of waste we generate is one way to conserve energy. The most obvious way to reduce waste is for consumers to purchase fewer throw-away goods. One way manufacturers could conserve energy would be to cut back on unnecessary packaging. (This is particularly important since so much packaging is plastic, which is made from oil.) Closely related to waste reduction is reusing waste. Many products that we customarily use once and discard could be used again; some could be used many times. This too reduces energy (and materials) consumption.

Recycling is another way to conserve energy and materials. Recycling a waste material means separating it from other wastes and processing it so that it can be used again. Some materials can be recycled an indefinite number of times, while others can only be recycled a limited number of times before their properties are altered too much for them to be used again for similar products. For example, aluminum cans and glass bottles can be recycled again and again, but paper is often recycled into lower grades of paper. Recycling saves vast amounts of energy. Recycling paper saves 30 to 55 percent of the energy required to produce paper from trees, and recycling aluminum cans saves about 95 percent of the energy required to produce them from the raw ore.

Using Waste as an Energy Resource

Energy may also be gained directly from waste materials. The most obvious way to do so is to burn it. Waste incineration is a carefully controlled process performed in a specially designed system; burning is efficient and clean. Most of the household wastes we discard each day are combustible—particularly paper and plastic. Anything that burns releases heat energy. This heat can be used to heat buildings or to generate electricity. Concerns about air quality and the high cost of waste incineration facilities have limited their use in the United States. Two waste incineration facilities in the Valley (both in Middle Tennessee) have been providing energy from waste for several years.

Waste materials can also be chemically changed to produce fuels which can then be burned. For example, pyrolysis is heating waste materials to very high temperatures in an oxygen-free environment; depending upon the wastes and/or the process, a gas- or oil-like fuel is produced. Methane, similar to natural gas, is produced when bacteria digest certain wastes under oxygen-free conditions.

There are two main advantages to using waste as an energy resource. The first is that it is a readily available, "renewable" resource that can help extend our supplies of conventional, nonrenewable resources. The second is that it helps alleviate our growing waste disposal problems. Of course there are also disadvantages to using energy from waste (such as air quality, economic, and organizational concerns), but we should continue to develop this energy option.

ENERGY HISTORY

Increase in Energy Use

Throughout human history, progress has been directly related to the development of new technologies and devices. These new devices and technologies have replaced the drudgery, danger, and exertion of many tasks that once required human or animal labor. In fact, they now enable us to perform tasks and procedures that our ancestors could not have imagined. We can do much more in much less time, but, in so doing, we use much more energy than our ancestors did.

It has been estimated that each American citizen uses over 46 times more energy each day than hunter-gatherer people did. We use about 11-12 times as much energy as American colonists did and about 4 times as much as our ancestors did 100 years ago. Not only has our per capita energy use continued to rise, but our population has also increased. The result is that the United States (U.S.) uses more energy than any other Nation in the world. Energy use is undeniably linked to standard of living, but it is also true that citizens of other industrialized nations enjoy standards of living that are comparable to ours but require only about half the energy consumption.

Energy Eras

As we have developed our energy-using technologies and our lifestyles have changed accordingly, the energy resources upon which we have depended most have also changed. Energy use history can be divided into three major fuel eras—the wood, coal, and oil eras.

For most of human history, firewood provided most of the energy people required for heating, cooking, and simple manufacturing processes such as firing pottery and making metal ornaments and tools. (Much of the world's population today still depends on wood energy.) In the U.S., blessed with extensive forests, wood was the primary fuel until about 100 years ago. Not only was it used in residences and other buildings, but it was also used by the steamboats and trains that served the growing Nation. Charcoal, made from wood, was an important industrial fuel. America was still mostly an agricultural, rural Nation; wood was plentiful, inexpensive, and able to meet our energy needs. By the Civil War years, however, the growth of industry and urban areas was beginning to cause people to turn to coal.

By 1900, coal was our primary fuel. Cities had grown larger, factories were more common, and supplies of wood were farther away and less plentiful. Coal is a more concentrated fuel than wood, so it became a more attractive fuel for industry. Edison had invented the electric light, and some of the first electric generating plants burned coal to produce the steam used to generate the newly demanded energy form. Many buildings burned coal for heat. Steam engines burned coal. The face of the Nation changed as the industrial revolution, fueled by coal, took place.

By 1950, a greater percentage of the total energy used in the U.S. was provided by oil than by coal. Many industries, buildings, and power plants were by then burning oil, but the greatest contributor to the fuel change was the growth in the number of automobiles in the U.S. We have always had more vehicles than any other Nation; all of them burn either gasoline or diesel fuel, both of which are made from oil.

The Energy Crisis

Our dependence on oil grew so quickly that we have imported oil since about 1940. The percentage of our oil that was purchased from foreign suppliers grew until, by 1973, over one-third of the oil we used was imported. In 1973, the Organization of Petroleum Exporting Countries (OPEC) was supplying about half of the imports we purchased. Late in that year, they ceased to ship oil to us due to a grievance with

U.S. foreign policy. In the five months of the oil embargo, many cities suffered gasoline and heating oil shortages, fuel prices skyrocketed, and inflation hit double digits. The resulting series of events was dubbed "the energy crisis," and our unthinking, insatiable, ever-increasing consumption of energy was finally challenged. The concept of conserving energy became common knowledge, and efforts to promote energy conservation were launched by many industries, agencies, and citizen groups.

We survived the energy crisis of the 1970s and its accompanying economic recession. As economic conditions have changed for the better in the 1980s, we are again increasing our rates of energy consumption (although the rates of increase are not as high as they were in the 1960s and early 1970s). We are buying bigger cars and building bigger houses. We are still importing about one-third of the oil we consume; the goal of national energy independence set during the energy crisis is only a memory.

A New Energy Era

The energy crisis has, however, produced some lasting changes in how we think of and use energy. We now have fuel economy ratings for vehicles and energy efficiency ratings for appliances. Buildings are now built with consideration for efficient heating, cooling, water heating, and lighting. Even more important than these changes is the move toward a more diversified energy future. We are using more renewable energy resources and looking toward the day in which we will rely on them as we have relied on nonrenewable fossil fuels for the last 100 years. Some experts call the energy era into which we are now beginning to shift the "diverse energy sources era." The strength of diversity may help us to avoid a real energy crisis in the future.

TVA HISTORY

Beginning a New Agency

President Franklin D. Roosevelt signed legislation creating the Tennessee Valley Authority (TVA) in 1933. The establishment of TVA grew out of years of debate on how to use two government-owned nitrate plants and the Wilson Dam at Muscle Shoals, Alabama. These projects were built to supply munitions for World War I, but the projects were unfinished when the war ended.

Senator George W. Norris of Nebraska was determined that these facilities be used for the public good and repeatedly fought off efforts to turn over the facilities to private interests. Finally, a newly elected president, determined to lift the Nation out of the Great Depression, expanded on Norris' ideas and proposed the creation of TVA. TVA became a part of the "New Deal," and Norris became known as the "father" of TVA. The first dam built by TVA, completed in 1936, was named for Senator Norris.

TVA was an experiment in national policy—a corporation with the power of the Federal Government and yet the initiative and flexibility of private enterprise. Furthermore, its mission was firmly rooted in the concept of the interconnectedness of the elements of the natural world and the activities of humans. The new agency was charged with planning for the proper use, conservation, and development of all the region's natural resources. TVA was an effort to bring together into a single agency the responsibility to develop the region's total resources in harmony with each other, rather than fragmenting the responsibility among many different agencies.

Roosevelt was criticized for the creation of TVA, and opposition to the idea continued for many years. Private power companies were especially opposed to government production of electricity and unsuccessfully challenged the constitutionality of TVA in the courts.

Taming the River

The first objective in the regional plan of the new Federal agency was to control the Tennessee River and use its vast strength for the economic good of the people. Though several small dams were purchased from utilities, TVA built most of its large dams. Those located along the main stream of the river form a continuous chain of lakes from Knoxville, Tennessee, to Paducah, Kentucky. Locks in the dams enable towboats and barges to be raised or lowered from one lake level to another; this stairway chain of locks provides a safe, year-round, 650-mile waterway for shipping. Dams were also built on the river's tributaries. All of these dams are operated as one system to control the flow of the rivers.

The provision of flood control was even more important than navigation. The reservoirs behind the dams are huge water storage areas. During flood season, controlled release of water helps reduce flooding not only in the Valley but also in the Ohio and lower Mississippi River basins.

Producing Power

The dams that tamed the Tennessee River and created an inland waterway for commercial shipping had yet another purpose, one that proved to be of vital importance to the long-term economic development of the Valley. They provided abundant and inexpensive electric power to the Valley region. Prior to the creation of TVA, electricity was too expensive for most people. TVA's hydroelectric dams made rural electrification possible and were a major factor in the development of a healthy economy in the Tennessee Valley.

During the early years of TVA, hydropower was the main source of electricity. As industrialization proceeded and the demands of residents and businesses also grew, the agency had to find other ways to generate power. Most of the power produced now comes from plants that use coal for fuel. The TVA power system also includes nuclear plants.

Agriculture

TVA used the chemical plants at Muscle Shoals as a national agricultural research and development laboratory. The National Fertilizer Development Center developed new and better ways to make and use fertilizers and was instrumental in restoring and revitalizing the farmland of the Tennessee Valley.

In the 1930s, the fortunes of farmers in the Valley changed dramatically through electrification, the use of fertilizers, and new farming techniques to control erosion and increase yields. Today TVA continues working with other agencies and farmers themselves to improve agricultural production while practicing the proper care of the land.

Forestry

Poor conservation of the Valley's abundant forest resources had contributed to erosion problems in pre-Depression years. TVA embarked on a massive effort to restore the region's woodlands, providing hundreds of millions of seedlings for reforestation and encouraging better forest management and fire control programs. Programs to reduce topsoil loss and develop forest products industries help ensure that the Valley's vast woodlands and its forest products industries will continue to make a significant contribution to the economy of the region.

Recreation

Many beautiful lakes were created by the dams on the Tennessee River and its tributaries. Governments and private interests have developed parks and other recreational facilities along their banks. The recreation and tourism industry has greatly benefited the economy of the Valley region. TVA works with many agencies to help oversee the wildlife and fisheries resources of these lakes and their surrounding areas.

Economic Development

In the 1930s, TVA's efforts were concentrated on mitigating serious problems of erosion, flooding, desperate rural poverty, and a lack of the resources and infrastructure (e.g., rural electrification) to begin building a healthy regional economy. The 1940s saw TVA expanding its power system to help in the war effort. Drawn by low-cost, abundant electricity and the waterway, industries began moving into the Valley. In the 1950s, the power system continued to grow; the navigation system was completed; and more industries located along the shores of the rivers and lakes. In the 1960s, TVA created an office to assist in local community and regionwide economic development. TVA continues to work with community planners, businesses and industries, and resource management specialists to contribute to sound economic growth in the region and in the Nation.